



WORLD
AQUATICS

Artistic Swimming

Figures Manual

2022 - 2025

ARTISTIC SWIMMING FIGURES MANUAL

TABLE OF CONTENTS

1. ANALYSIS OF FIGURES	Analysis of Body Positions & Basic Movements
2. CATEGORY I	Figures # 101 to 154j-2
3. CATEGORY II	Figures # 226 to 241
4. CATEGORY III	Figures # 301 to 364
5. CATEGORY IV	Figures #401 to 441e
6. PHOTO LIBRARY	Photo Library of all World Aquatics Figures

Foreword

This Manual has been created as a worldwide figures resource library for judges, coaches, referees and athletes.

As the number of figures continues to expand and the number of competitions at all age groups and levels increases, the need for a manual to contain all FINA figures became evident.

For each of the current recognized 2022-2025 World Aquatics Figures, there are figure descriptions with additional explanations provided in the major desired actions section. The Basic Body Positions and Basic Movements relevant for each figure have been provided within the figure for quick reference.

Additionally, a photo library of all World Aquatics figures is provided as a visual reference.

There have been many contributors to this manual. My special thanks to Maria José Bilbao, Miwako Homma, Louise Kennedy and Lianna Sottile for their continual help and contributions.

Production of Artistic Swimming educational materials such as this Manual would not be possible without the financial support of World Aquatics, the excellent work of the World Aquatics Office Staff and the leadership of the TASC. Special recognition and thanks to all former and current TASC members who provided input to the figures.

On behalf of the Artistic Swimming family around the world who will use this Manual, thank you all very much. Your contributions are greatly appreciated.

Diane van der Pol
Editor



Artistic Swimming Figures Manual
2022 – 2025

Part 1

Figures Analysis BP & BM



ANALYSIS OF FIGURES

1. ANALYSIS OF BASIC BODY POSITIONS



In all basic body positions:

- a) arm positions are optional,
- b) toes must be pointed, ankles must be extended,
- c) the legs, trunk and neck are fully extended unless otherwise specified and
- d) diagrams are a guide only. If there is a discrepancy between a diagram and a written description, the English written Body Position description prevails.


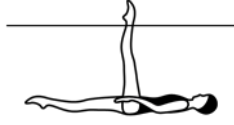
BP 1 Back Layout Position

Body Position Description	Diagrams	Major Desired Actions
1. Body extended with face, chest, thighs and feet at the surface of the water.		1. Gives the impression that the body is stretched horizontally to its maximum. Front of the trunk will also be at the surface of the water.
2. Head (ears specifically), hips and ankles in horizontal alignment.		2. Judgement is made by checking visual points of the horizontal alignment: ears, shoulder joints, hip joints and ankles. This imaginary line should also pass through the middle of the side of the trunk.


BP 2 Front Layout Position

Body Position Description	Diagrams	Major Desired Actions
1. Body extended with head, upper back, buttocks and heels at the surface of the water.		1. Gives the impression that the body is stretched horizontally to its maximum. Judgement made by checking visual points of the horizontal alignment: ears, shoulder joints, hip joints and heels.
2. Unless otherwise specified, face may be in or out of the water.		2. Once the head position is established as in or out of the water the position is maintained. When the face is out of the water the ears will not be on the horizontal axis and the back may be slightly lower and arched. Hip joints, calves and heels remain at the surface of the water.


BP 3 Ballet Leg Position

Body Position Description	Diagrams	Major Desired Actions
a) Surface 1. Body in Back Layout Position . 2. One leg extended perpendicular to the surface of the water.		1. See BP 1 Back Layout Position . Ears, shoulder joints, hip joints and ankle of extended leg in line at maximum horizontal alignment. 2. 90 ° angle between the extended leg and the surface of the water and between the extended leg and the trunk with maximum horizontal alignment maintained throughout.
b) Submerged 1. Head, trunk and horizontal leg parallel to the surface of the water. 2. One leg perpendicular to the surface with the water level between the knee and the ankle.		1. See body alignment requirements of BP 1 Back Layout Position . 2. The angles between the ballet leg and the body must remain at 90° throughout.


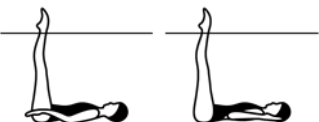
BP 4 Flamingo Position

Body Position Description	Diagrams	Major Desired Actions
a) Surface 1. One leg extended perpendicular to the surface of the water. 2. The other leg bent with the mid-calf opposite the vertical leg. Foot, shin and knee at and parallel to the surface of the water. 3. Face at the surface of the water.		1. 90° angle between the extended leg and the surface of the water. 2. The top of the bent leg from knee to toes should be dry with the vertical leg extended perpendicular midway between knee and ankle of the horizontal leg. 3. Chest close to the surface of the water with the shoulders back. Ears, shoulder joints and hip joints aligned with the spine straight and extended.

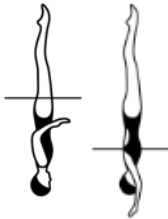

BP 4 Flamingo Position (cont.)

Body Position Description	Diagrams	Major Desired Actions
b) Submerged 1. Trunk, head, shin and foot of the bent leg parallel to the surface of the water.		1. Ears, shoulder joints and hip joints aligned.
2. 90° angle between the trunk and extended leg.		2. The vertical leg is extended perpendicular to the bent leg midway between the knee and the ankle of the horizontal leg.
3. Water level between knee and ankle of the extended leg.		

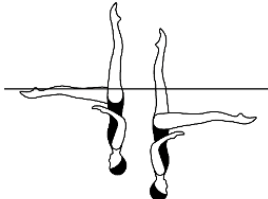
BP 5 Ballet Leg Double Position

Body Position Description	Diagrams	Major Desired Actions
a) Surface 1. Legs together and extended perpendicular to the surface of the water.		1. Full extension of the legs at a 90° angle to the surface of the water.
2. Head in line with the trunk.		2. Chest close to the surface of the water with the shoulders back. Ears, hip joints and shoulder joints aligned, with the spine straight and extended.
3. Face at the surface of the water.		
b) Submerged 1. Trunk and head parallel to the surface of the water.		1. Ears, shoulder joints and hip joints aligned.
2. 90° angle between the trunk and the extended legs.		2. Legs perpendicular to the surface of the water. Body extended horizontally at 90° angle to the surface of the water.
3. Water level between knees and ankles of the extended legs.		

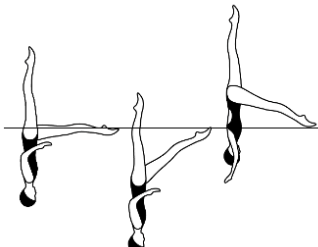
BP 6 Vertical Position

Body Position Description	Diagrams	Major Desired Actions
1. Body extended perpendicular to the surface of the water; legs together, head downward.		1. Full extension of the body.
2. Head (ears specifically), hips and ankles in line.		2. Judgement made by checking visual points of the vertical alignment: ears, shoulder joints, hip joints and ankles.




BP 7 Crane Position - this position is currently not performed in any FINA figure.

Body Position Description	Diagrams	Major Desired Actions
1. Body extended in Vertical Position with one leg extended forward at a 90° angle to the body.		1. Refer to BP 6 Vertical Position re body alignment. Forward extended leg must be parallel to the surface. Hip joints must be on a horizontal line.



BP 8 Fishtail Position

Body Position Description	Diagrams	Major Desired Actions
1. Body extended in Vertical Position with one leg extended forward. The foot of the forward leg is at the surface of the water regardless of the height of the hips.		1. See BP 6 Vertical Position for body alignment. The foot of the forward leg must be at the surface of the water. Hip joints must be on a horizontal line.



BP 9 Tuck Position

Body Position Description	Diagrams	Major Desired Actions
1. Body as compact as possible, with the back rounded and the legs together.		1. Legs together with shins at the surface of the water and tucked tightly to the front of the body.
2. Heels close to buttocks.		2. Compact tuck. Chin tucked in.
3. Head close to knees.		3. In BP 9 inverted Tuck Position , shins are perpendicular to the surface of the water, buttocks remain at the surface and the water level is between the ankle and mid foot.


BP 10 Front Pike Position

Body Position Description	Diagrams	Major Desired Actions
1. Body bent at hips to form a 90° angle.		1. Exact 90° angle.
2. Legs extended and together.		2. Full extension of legs, with ankles aligned with hip joints.
3. Trunk extended with the back straight and head in line.		3. Back flat, with vertical alignment of ears, shoulder joints and hip joints once the position is established.

BP 11 Back Pike Position

Body Position Description	Diagrams	Major Desired Actions
1. Body bent at hips to form an acute angle of 45° or less.		1. Legs close to chest while maintaining the straight line alignment of the extended spine and head.
2. Legs extended and together.		2. Full extension of the legs, ankles and feet.
3. Trunk extended with the back straight and head in line.		3. Back flat, with ears, shoulder joints, middle of side of torso, and hip joints aligned. Once the pike position is established the degree of the angle remains constant.

BP 13 Surface Arch Position

Body Position Description	Diagrams	Major Desired Actions
1. Lower back arched with hips, shoulders and head on a vertical line.		1. Hip joints and shoulder joints on a horizontal line with both of these alignments 'square' and parallel to one another. Head (ears specifically) in line with shoulders.
2. Legs together and at the surface of the water.		2. Hip joints at the surface of the water.

BP 14 Bent Knee Positions

Body Position Description	Diagrams	Major Desired Actions
---------------------------	----------	-----------------------

1. Body in **Front Layout, Back Layout, Vertical, or Arched Positions**.

2. One leg bent, with the toe of the bent leg in contact with the inside of the extended leg at the knee or higher.

1. See BP 2, BP 1, BP 6, and BP 13.

2. The relationship of the toe of the bent leg to the extended leg may vary depending on the figure but should remain constant once established, and not extend in front of or behind the extended leg.

a) Bent Knee Front Layout Position

1. Body extended in **Front Layout Position** with the thigh of the bent leg perpendicular to the surface of the water.



1. In BP 2 **Front Layout Position** the alignment of the extended leg, trunk and head remains constant.

2. Unless otherwise specified face may be in or out of the water.

2. Once established as in or out of the water, the head position is maintained. When the face is out of the water, the ears will not be on the horizontal axis, and the back may be slightly lower and arched. Hip joints, and the calf and heel of the extended leg remain at the surface of the water.

b) Bent Knee Back Layout Position

1. Body extended in **Back Layout Position**.



1. In BP 1 **Back Layout Position** ears, shoulder joints, hip joints and ankle of extended leg in line at maximum horizontal alignment.

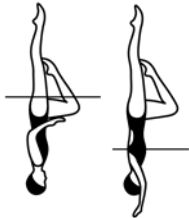


2. The thigh of the bent leg is perpendicular to the surface of the water.




2. 90° angle between the thigh and the surface of the water, and 90° angle maintained between the thigh and the trunk. At maximum height an air pocket will be evident between the back of the thigh and calf of the bent leg and the surface of the water.





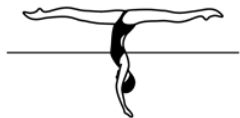
BP 14 Bent Knee Positions (cont.)

Body Position Description	Diagrams	Major Desired Actions
<p>c) Bent Knee Vertical Position</p> <p>1. Body extended in Vertical Position with the thigh of the bent leg parallel to the surface of the water.</p>		<p>1. In BP 6 Vertical Position the alignment of the extended leg, trunk and head remains constant.</p>
<p>d) Bent Knee Surface Arch Position</p> <p>1. Lower back arched with hips, shoulders and head on a vertical line.</p>		<p>1.1 In BP 13 Surface Arch Position shoulder joints and hip joints on a horizontal line with both of these alignments 'square' and parallel to one another. Head (ears specifically) in line with shoulders.</p> <p>1.2 Hips at the surface of the water.</p>
<p>2. The thigh of the bent leg is perpendicular to the surface of the water.</p>		<p>2. 90° angle between the thigh of the bent leg and the surface of the water. An air pocket will be evident between the back of the thigh and calf of the bent leg and the surface of the water.</p>

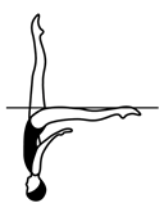
BP 15 Tub Position

Body Position Description	Diagrams	Major Desired Actions
1. Legs bent and together, feet and shins at and parallel to the surface of the water with thighs perpendicular.		1. Knees and hip joints aligned vertically with thighs perpendicular to the surface of the water. Legs dry from toes to knees.
2. Head in line with trunk.		2. Chest close to the surface of the water, with the shoulders back. Ears, shoulder joints and hip joints aligned, with the spine extended.
3. Face at the surface of the water.		


BP 16 Split Position

Body Position Description	Diagrams	Major Desired Actions
1. Legs evenly split forward and back. 2. The legs are parallel to the surface of the water. 3. Lower back arched, with hips, shoulders and head on a vertical line. 4. 180° angle between the extended legs (flat split), with inside of each leg aligned on opposite sides of a horizontal line, regardless of the height of the hips.		1. Full extension of the legs at or above the surface of the water.
a) Surface Split Position 1. Legs are dry at the surface of the water.		
b) Airborne Split Position 1. Legs are above the surface of the water.		1. Full extension of the legs. Crotch and legs dry at the surface of the water.
		1.1 Full extension of the legs completely above the surface of the water. Maximum height is desirable. 1.2 Both legs equidistant from the surface of the water.

BP 17 Knight Position

Body Position Description	Diagrams	Major Desired Actions
1. Lower back arched, with hips, shoulders and head on a vertical line.		1. Arch is in the lower part of the spine only.
2. One leg vertical.		2. Vertical alignment through ears, shoulder joints, hip joints and ankle of the vertical leg.
3. Other leg extended backward with the leg at the surface of the water and as close to horizontal as possible.		3. Hip joints and shoulder joints on a horizontal line with both of these alignments 'square' and parallel to each other. The top of the horizontal extended leg faces upward.

BP 18 Knight Variant Position

Body Position Description	Diagrams	Major Desired Actions
1. Lower back arched, with hips, shoulders and head on a vertical line.		1. Arch is in the lower part of the spine only.
2. One leg vertical.		2. Vertical alignment through ears, shoulder joints, hip joints and ankle of the vertical leg.
3. The other leg is behind the body with the knee bent at an angle of 90° or less.		3. Hip joints and shoulder joints on a horizontal line with both of these alignments 'square' and parallel to each other. The top of the horizontal extended leg faces upward.
4. The thigh and shin of the bent leg are parallel to the surface of the water.		4. The inside of the bent leg faces upward and is at or near the surface of the water.

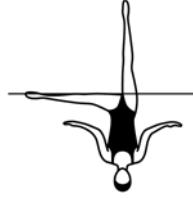
BP 19 Side Fishtail Position

Body Position Description

Diagrams

Major Desired Actions




1. Body extended in **Vertical Position** with one leg extended sideways with the foot at the surface of the water regardless of the height of the hips.





1. BP 6 **Vertical Position** alignment must be evident from a front or back view of the extended body. The head, trunk and extended leg face forward.

2. ANALYSIS OF BASIC MOVEMENTS




BM 1 To Assume a Ballet Leg/A Ballet Leg is assumed

Basic Movement Description	NVT	Diagrams	Major Desired Actions
1. Begin in a Back Layout Position . One leg remains at the surface of the water throughout.			1. See BP 1 Back Layout Position .
2. The foot of the other leg is drawn along the inside of the extended leg to assume a Bent Knee Back Layout Position .	10.5		2. See BP 14b Bent Knee Back Layout Position . The toe of the bending leg remains in contact with the inside of the extended leg. Minimal drop in hips. Position held only long enough to demonstrate control and accuracy.
3. The bent leg is straightened without movement of the thigh to assume a Ballet Leg Position .	11.0		3.1 See BP 3a Surface Ballet Leg Position . Height remains constant throughout the movement. 3.2 The head and trunk remain stationary throughout.

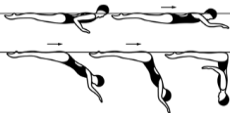
BM 1B To Assume a Straight Ballet Leg/A Straight Ballet Leg is assumed

Basic Movement Description	NVT	Diagrams	Major Desired Actions
1. From a Back Layout Position one leg is raised straight to a Ballet Leg Position .			1.1 See BP 1 Back Layout Position . Ears, shoulder joints, hip joints and ankles of extended legs at maximum horizontal alignment.
	18.5		1.2 One leg is raised straight to BP 3a Surface Ballet Leg Position while keeping the horizontal alignment of the horizontal leg and trunk with minimal drop of the hips. 1.3 The head and trunk remain stationary throughout.


BM 2 To Lower a Ballet Leg/The Ballet Leg is lowered

Basic Movement Description	NVT	Diagrams	Major Desired Actions
1. From a Ballet Leg Position the ballet leg is bent without movement of the thigh to a Bent Knee Back Layout Position .			1. See BP 3a Surface Ballet Leg Position and BP 14b Bent Knee Back Layout Position . Height remains constant throughout the movement.
2. The toe moves along the inside of the extended leg until a Back Layout Position is assumed.	11.0		2.1 Full extension in BP 1 Back Layout Position to be achieved as the feet are joined. 2.2 The head and trunk remain stationary throughout.
	10.5		


BM 3 To Assume a Front Pike Position/A Front Pike Position is assumed

Basic Movement Description	NVT	Diagrams	Major Desired Actions
1. From a Front Layout Position with the face in the water the trunk moves downward to assume a Front Pike Position . The buttocks, legs and feet travel along the surface of the water until the hips occupy the position of the head at the beginning of this action.	6.0		1.1 See BP 2 Front Layout Position and BP 10 Front Pike Position . Uniform motion in downward movement of the trunk. The trunk remains straight throughout the movement. Hips and head lock into position simultaneously. 1.2 Unless otherwise specified, <i>To Assume a Front Pike Position</i> starts from a Front Layout Position .


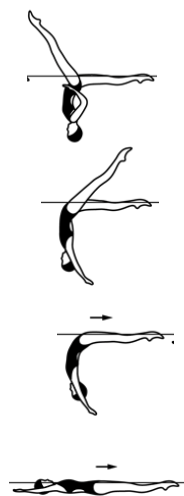
BM 4 To Assume a Submerged Ballet Leg Double Position From a Front Pike Position/A Submerged Ballet Leg Double Position is assumed

Basic Movement Description	NVT	Diagrams	Major Desired Actions
1. While maintaining a Front Pike Position the body somersaults forward around a lateral axis as the buttocks, legs and feet move downward. The hips replace the head to assume a Submerged Ballet Leg Double Position .	8.0		1.1 See BP 10 Front Pike Position and BP 5b Submerged Ballet Leg Double Position . 90° angle between the trunk and the legs maintained throughout the rotation. 1.2 Body alignment and extension maintained throughout.



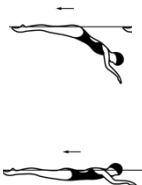
BM 5 Arch to Back Layout Finish Action

Basic Movement Description	NVT	Diagrams	Major Desired Actions
1. From a Surface Arch Position the hips, chest and face surface sequentially at the same point with foot first movement to a Back Layout Position until the head occupies the position of the hips at the beginning of this action.	7.0		1. See BP 13 Surface Arch Position . Sharp arch in lower back. The body straightens, rises and moves along the surface of the water with a stationary BP 1 Back Layout Position achieved as the face surfaces. Full extension maintained throughout.




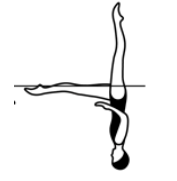
BM 6 Walkouts

Basic Movement Description	NVT	Diagrams	Major Desired Actions
1. These movements start in a Split Position unless otherwise specified in the figure description. The hips remain stationary as one leg is lifted in an arc over the surface of the water to meet the opposite leg. a) Walkout Front			1. See BP 16a Surface Split Position .
2. The front leg is lifted in a 180° arc over the surface of the water to meet the opposite leg in a Surface Arch Position and with continuous movement an <i>Arch to Back Layout Finish Action</i> is executed.	23.0 7.0		2.1 Hip height remains constant and at the surface of the water. 2.2 Arcing leg moves continuously with uniform motion. 2.3 Both legs maintain full extension. 2.4 The trunk remains stationary until the feet join. 2.5 No pause in BP 13 Surface Arch Position , however an accurate surface arch must be evident before the body begins to rise and straighten. 2.6 Foot first surfacing motion begins when the feet are joined. 2.7 See BP 13 Surface Arch Position and BM 5 <i>Arch to Back Layout Finish Action</i> .



BM 6 Walkouts

Basic Movement Description	NVT	Diagrams	Major Desired Actions
1. These movements start in a Split Position unless otherwise specified in the figure description. The hips remain stationary as one leg is lifted in an arc over the surface of the water to meet the opposite leg.			1. See BP 16a Surface Split Position .
b) Walkout Back	19.0		3.1 Hip height remains constant and at the surface of the water. 3.2 Arcing leg moves continuously with uniform motion. 3.3 Both legs maintain full extension. 3.4 The trunk remains stationary until the feet join. 3.5 An accurate BP 10 Front Pike Position should be evident before the body begins to straighten and rise. See BP 10 Front Pike and BP 2 Front Layout Position .
4. The head surfaces at the position occupied by the hips at the beginning of this action.	6.0		4. The body straightens, rises and moves along the surface simultaneously with a stationary BP 2 Front Layout Position achieved as the head surfaces.

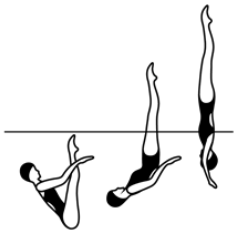
BM 7 Catalina Rotation

Basic Movement Description	NVT	Diagrams	Major Desired Actions
1. From a Ballet Leg Position a rotation of the body is initiated.	24.0		1. See BP 3 Ballet Leg Position .
2. The head, shoulders and trunk begin the rotation at the surface of the water while descending without lateral movement to a Fishtail Position .		 	2.1 Rotation begins no later than when the nose goes beneath the surface of the water. 2.2 Simultaneous rotation and descent of the trunk along the vertical line established by the vertical leg. 2.3 At the halfway point, the body is in a tilted 'Y' position, with the trunk at a 45° angle to the surface of the water, and the head, trunk and legs face forward. 2.4 Height and uniform motion throughout. 2.5 See BP 8 Fishtail Position .
3. The vertical leg remains perpendicular to the surface of the water while the foot of the horizontal leg remains at the surface of the water throughout the rotation. Unless otherwise specified, <i>Catalina Rotation</i> starts from a Ballet Leg Position .			3. Each leg rotates around its respective horizontal or vertical axis, simultaneously throughout the rotation of the descending trunk.

BM 8 Catalina Reverse Rotation

Basic Movement Description	NVT	Diagrams	Major Desired Actions
1. From a Fishtail Position the hips rotate as the trunk rises without lateral movement to assume a Ballet Leg Position .	24.0		1.1 See BP 8 Fishtail and BP 3a Surface Ballet Leg Positions . 1.2 Height maintained and uniform motion throughout. 1.3 The body rotates and rises simultaneously along the vertical line established by the vertical leg. 1.4 The transition is completed as the face surfaces and the body locks into BP 3a Surface Ballet Leg Position . 1.5 At the halfway point, the body is in a tilted 'Y' position, with the trunk at a 45° angle to the surface of the water and the head, trunk and legs face forward.
2. The vertical leg remains perpendicular to the surface of the water while the foot of the horizontal leg remains at the surface of the water throughout the rotation.			2. Each leg rotates around its respective horizontal or vertical axis simultaneously throughout the rotation of the ascending trunk.

BM 9 Thrust

Basic Movement Description	NVT	Diagrams	Major Desired Actions
<p>1. From a Submerged Back Pike Position with the legs perpendicular to the surface of the water a vertical upward movement of the legs and hips is rapidly executed as the body unrolls to assume a Vertical Position.</p>	31.0		<p>1.1 See BP 11 Back Pike Position. The toes are just below the surface of the water. Once established, the degree of the angle of the pike position between the legs and the body must not change prior to initiation of the <i>Thrust</i>.</p> <p>1.2 See BP 6 Vertical Position. The body unrolls rapidly under the legs to assume BP 6 Vertical Position along the same perpendicular line to the surface of the water established by the legs in the BP 11 Back Pike Position.</p> <p>1.3 Obvious increase in speed from the initiation of body unrolling through the vertical upward movement.</p>
<p>2. Maximum height desirable.</p>			<p>2. Maximum height and BP 6 Vertical Position achieved simultaneously.</p>

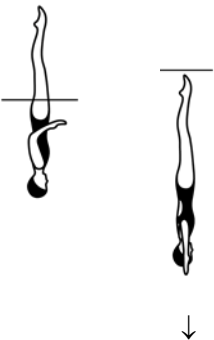
THRUST ALLOWANCE

Deviation allowances for the *Thrust* action are unique and allow for the legs to be up to an additional 15 degrees off the vertical line.


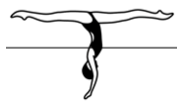


Deductions are as follows:

	Angle Deviation	Deduction Amount
Small Deviation	0 – 30 degrees	.2
Medium Deviation	31 – 44 degrees	.5
Large Deviation	45 degrees or more	1.0

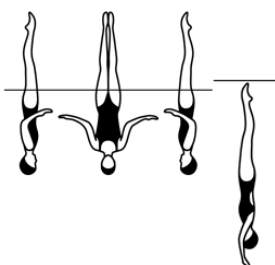
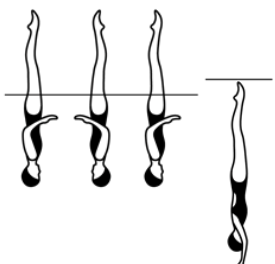
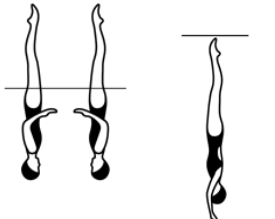
BM 10 Vertical Descent

Basic Movement Description	NVT	Diagrams	Major Desired Actions
1. Maintaining a Vertical Position the body descends along its longitudinal axis until the toes are submerged.	14.0		1. See BP 6 Vertical Position . Unless otherwise stated, the tempo of the descent is uniform and at the same speed as the rest of the figure.

BM 11 Rocket Split

Basic Movement Description	NVT	Diagrams	Major Desired Actions
1. A <i>Thrust</i> is executed to a Vertical Position . Maintaining maximum height the legs are split simultaneously and rapidly to assume an Airborne Split Position and rejoin to a Vertical Position , followed by a <i>Vertical Descent</i> .	31.0		1.1 See BM 9 <i>Thrust</i> (steps 1.1 to 2), BP 11 Back Pike Position , BP 6 Vertical Position , BP16b Airborne Split Position . 1.2 The toes are just below the surface of the water. 1.3 Full extension of the legs above and parallel to the surface of the water.
	17.0		1.4 The legs split evenly and rejoin in the same vertical line. No travel permitted.
	13.0		
2. The <i>Vertical Descent</i> is executed at the same tempo as the <i>Thrust</i> .	13.0		2. See BM 10 <i>Vertical Descent</i> .

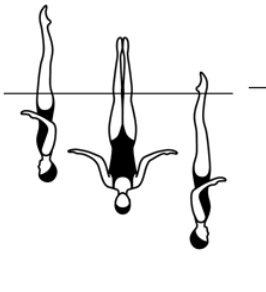
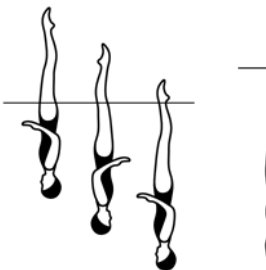
BM 12 Twists

Basic Movement Description	NVT	Diagrams	Major Desired Actions
1. A <i>Twist</i> is a rotation at a sustained height.			1. Height remains constant throughout the rotation. Stability and alignment of the position is evident before, during and upon completion of the <i>Twist</i> . The amount of height is judged by the relationship of the hip joints to the surface of the water with maximum height desirable.
2. The body remains on its longitudinal axis throughout the rotation.			2. The longitudinal axis runs through the centre of the body and is perpendicular to the surface of the water. On the spot rotation around this axis.
3. Unless otherwise specified when performed in a Vertical Position a <i>Twist</i> is completed with a <i>Vertical Descent</i> .			3. See BM 10 <i>Vertical Descent</i> . Unless otherwise specified the speed of the descent is the same as that of the root figure.
4. a) Half Twist: a <i>Twist</i> of 180°.	21.0 14.0		See Twist Allowance.
b) Full Twist: a <i>Twist</i> of 360°.	32.0 14.0		See Twist Allowance.
c) A Twirl: a rapid <i>Twist</i> of 180°.	26.0 14.0		See Twist Allowance. 4. c) Definite increase in speed from the root figure. Stability of body alignment and height remains constant during and after completion of the <i>Twirl</i> .

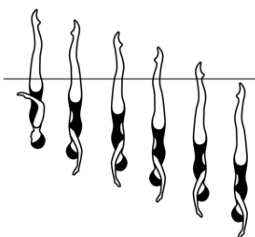
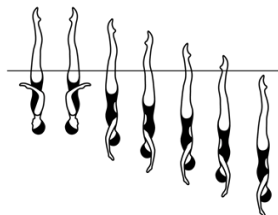
Twist Allowance

The acceptable allowance for *Twist* rotations (*Half Twist*, *Full Twist* and *Twirl*) is up to ¼ less than/more than the required rotation.

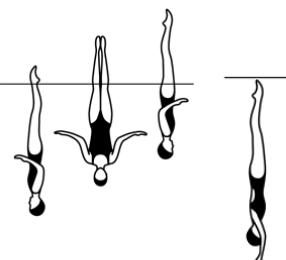
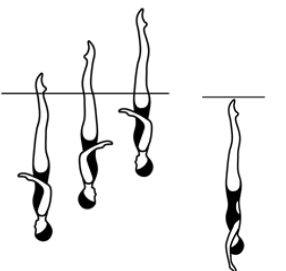
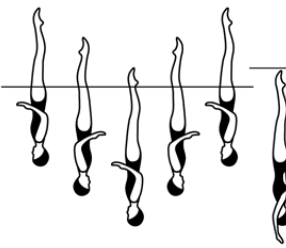
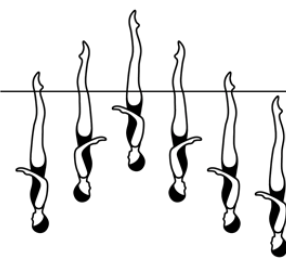
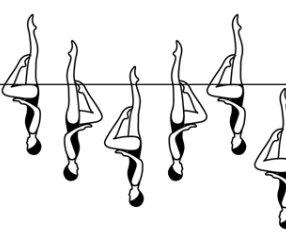
BM 13 Spins

Basic Movement Description	NVT	Diagrams	Major Desired Actions
<p>1. A <i>Spin</i> is a rotation in a Vertical Position.</p> <p>2. The body remains on its longitudinal axis throughout the rotation.</p> <p>3. Unless otherwise specified <i>Spins</i> are executed in uniform motion and are completed with a <i>Vertical Descent</i> executed at the same tempo as the <i>Spin</i>.</p> <p>4. A <i>descending Spin</i> must start at the height of the vertical and be completed as the ankle(s) reach(es) the surface of the water. Unless otherwise specified a <i>descending Spin</i> is completed with a <i>Vertical Descent</i> which is executed at the same tempo as the <i>Spin</i>.</p>			<p>1. See BP 6 Vertical Position. Height and position attained before the <i>Spin</i> begins.</p> <p>2. The longitudinal axis runs through the centre of the body and is perpendicular to the surface of the water.</p> <p>3. Uniform motion of the <i>Spin</i> and <i>Vertical Descent</i> to be at the same tempo as the root figure unless otherwise specified. See BM 10 <i>Vertical Descent</i>.</p> <p>4.1 Stability and vertical alignment before, during and at completion of the designated rotation. 4.2 Simultaneous rotation and descent of the body with even drop spaces to complete the spin as the ankles reach the surface of the water.</p>
<p>5. d) 180° Spin/Spinning 180°: a <i>descending Spin</i> with a rotation of 180°.</p>	16.0 (stable) 24.0 (unstable-rapid)		See Spin Allowance.
<p>e) 360° Spin/Spinning 360°: a <i>descending Spin</i> with a rotation of 360°.</p>	19.0 (stable) 39.0 (unstable-rapid)		See Spin Allowance.

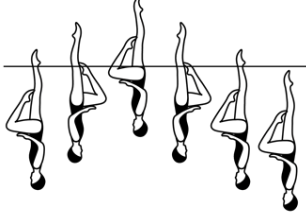
BM 13 Spins

Basic Movement Description	NVT	Diagrams	Major Desired Actions
<p>5. f) Continuous Spin: a <i>descending Spin</i> with a rapid rotation of: 720° (2), 1080° (3), or 1440° (4) which is completed as the ankles reach the surface of the water and continues through submergence.</p> <p>Continuous Spin 720° shown →</p>	<p>34.0 (720°) (rapid) 67.0 (720°) (rapid-unstable) 49.0 (1080°) (rapid) 60.0 (1440°) (rapid)</p>		<p>See Spin Allowance. 5 f) A <i>Continuous Spin</i> must achieve and maintain a rapid rotation throughout.</p>
<p>g) Twist Spin: a <i>Half Twist</i> is executed and without a pause is followed by a <i>Continuous Spin</i> of 720° (2) performed in the same direction as the <i>Half Twist</i>.</p>	<p>48.0</p>		<p>See Spin Allowance. 5 g) In a <i>Twist Spin</i>, the BM 12a <i>Half Twist</i> is performed at the same tempo as the root figure. The <i>Continuous Spin</i> must be performed rapidly and in the same direction as the <i>Half Twist</i>. See BM 12a <i>Half Twist</i> and BM13 f <i>Continuous Spin</i>.</p>
<p>6. An <i>ascending Spin</i> begins with the water level at the ankles unless otherwise specified.</p>	<p>20.0 (Asc. 180°) 21.0 (Asc. Rpd 180°) 21.0 (Asc. 360°)</p>		<p>See Spin Allowance. 6.1 Body rises and rotates simultaneously, evenly and at the same tempo as the root figure unless otherwise specified. 6.2 The designated rotation is completed simultaneously with achievement of maximum height. 6.3 Stability and vertical alignment maintained before, during and at completion of the designated rotation. Refer to BM 6 Vertical Position evident prior to <i>Vertical Descent</i>.</p>
<p>7. A vertical upward <i>Spin</i> is executed until a water level is established between the knees and hips.</p>			
<p>8. An <i>ascending Spin</i> is finished with a <i>Vertical Descent</i>.</p>			<p>8. See BM10 <i>Vertical Descent</i>. Speed of descent is the same as that specified in the root figure, unless otherwise specified.</p>

BM 13 Spins

Basic Movement Description	NVT	Diagrams	Major Desired Actions
9. h) Spin Up 180°: an ascending Spin with a rotation of 180°.	18.0 14.0		See Spin Allowance.
i) Spin Up 360°: an ascending Spin with a rotation of 360°.	19.0 14.0		See Spin Allowance.
j) Combined Spin: a descending Spin of at least 360° followed without a pause by an equal ascending Spin in the same direction. The ascending Spin reaches the same height where the descending Spin started.	38.0 14.0		See requirements for ascending and descending Spins, with uniform motion at the tempo specified in the figure description.
k) Reverse Combined Spin: an ascending Spin of at least 360° followed without a pause by an equal descending Spin in the same direction.	38.0		See requirements for ascending and descending Spins, with uniform motion at the tempo specified in the figure description.
l) Bent Knee Combined Spin: a descending Spin in a Bent Knee Vertical Position of at least 360° followed without a pause by an equal ascending Spin in the same direction in a Bent Knee Vertical Position. The ascending Spin reaches the same height where the descending Spin started.	30.0 10.0		See requirements for ascending and descending Spins, with uniform motion at the tempo specified in the figure description.

BM 13 Spins



Basic Movement Description	NVT	Diagrams	Major Desired Actions
9 m) Reverse Bent Knee Combined Spin: an <i>ascending Spin</i> in a Bent Knee Vertical Position of at least 360° followed without a pause by an equal <i>descending Spin</i> in the same direction in a Bent Knee Vertical Position .	30.0		See requirements for <i>ascending</i> and <i>descending Spins</i> , with uniform motion at the tempo specified in the figure description.

Spin Allowance



1-The acceptable allowance for a *Continuous Spin* is up to 180° less than/more than the required rotation.

2-The acceptable allowance for other *Spins* (180° Spin, 360° Spin, 720° Spin, Twist Spin, Spin Up 180°, Spin Up 360°) is up to ¼ less than/more than the required rotation.

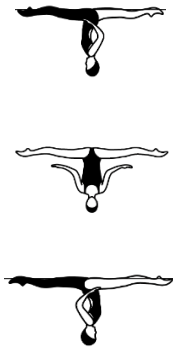
BM 14 To Assume a Surface Arch Position/A Surface Arch Position is Assumed

Basic Movement Description	NVT	Diagrams	Major Desired Actions
1. From a Back Layout Position with the head leading, the head, hips and feet move along the surface of the water.			1. See BP 1 Back Layout Position .
2. With continuous movement the head leaves the surface of the water as the back is arched more to assume a Surface Arch Position with the hips occupying the position of the head at the beginning of this action.	12.0		2. Continuous uniform movement from the BP 1 Back Layout Position to BP 13 Surface Arch Position . Hip height remains constant. Hip joints on a horizontal line.

BM 15 To Assume a Bent Knee Surface Arch Position/A Bent Knee Surface Arch is Assumed

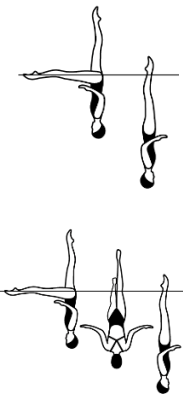
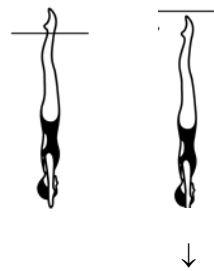
Basic Movement Description	NVT	Diagrams	Major Desired Actions
1. From a Back Layout Position with the head leading, the head, hips and feet move along the surface of the water.			1. See BP 1 Back Layout Position .
2. With continuous movement the head leaves the surface of the water as the back is arched more to assume a Bent Knee Surface Arch Position with the hips occupying the position of the head at the beginning of this action.	17.5		2.1 Continuous uniform movement from the BP 1 Back Layout Position to BP 14d Bent Knee Surface Arch Position . Hip height remains constant. Hip joints on a horizontal line. 2.2 The toe of the bent leg must remain in contact with the inside of the extended leg while assuming the Bent Knee Surface Arch Position .

BM 16 Ariana Rotation

Basic Movement Description	NVT	Diagrams	Major Desired Actions
1. From a Split Position maintaining the relative position of the legs to the surface of the water the hips rotate 180°.	17.0		1.1 See BP 16a Surface Split Position . 1.2 The trunk turns 180° around its longitudinal axis, while the legs rotate with no lateral movement at the surface of the water. 1.3 Height and extension of the Split Position is maintained throughout. 1.4 Uniform motion throughout. 1.5 Lower back arched with hips, shoulders and head on a vertical line. 1.6 Hip joints and shoulder joints on a horizontal line with both of these alignments 'square' and parallel to each other.

BM 17 Helicopter Rotation

Basic Movement Description	NVT	Diagrams	Major Desired Actions
<p>1. From a Fishtail Position the horizontal leg is lifted while closing into the vertical leg to assume a Vertical Position during a descending rotation and is completed as the ankles reach the surface of the water.</p>			<p>1.1 See BP 8 Fishtail Position. The legs are joined while descending and rotating to assume a BP 6 Vertical Position at ankle level. This position is reached as the legs are joined and the rotation is completed.</p> <p>1.2 The vertical leg maintains the vertical line throughout the rotation.</p> <p>1.3 Longitudinal axis is maintained throughout the rotation.</p> <p>1.4 Unless otherwise specified, the tempo of the rotation and descent is uniform and at the same speed as the root figure.</p> <p>1.5 Refer to Section BM 13 <i>Spins</i> and <i>Spin Allowances</i>.</p>

Basic Movement Description	NVT	Diagrams	Major Desired Actions
<p>a) Spinning 180°</p> <p>a) Spinning 180°: A descending <i>Spin</i> with a rotation of 180°.</p>	<p>12.5</p>		<p>Refer to BM 17 <i>Helicopter Rotation</i> Step 1 Major Desired Actions.</p>
<p>2. Maintaining a Vertical Position the body descends along its longitudinal axis until the toes are submerged.</p>	<p>0</p>		<p>2. See BP 6 Vertical Position and BM 10 <i>Vertical Descent</i>. The tempo of the descent is uniform and at the same speed as the rest of the figure.</p>

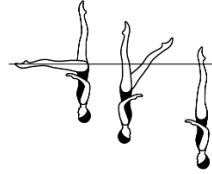
BM 17 Helicopter Rotation (cont.)

Basic Movement Description	NVT	Diagrams	Major Desired Actions
----------------------------	-----	----------	-----------------------

b) Spinning 360°

b) **Spinning 360°**: A descending Spin with a rotation of 360°.

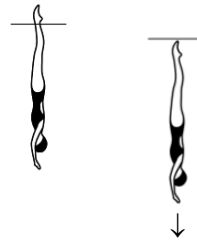
17.5



Refer to BM 17 *Helicopter Rotation* Step 1 Major Desired Actions.

2. Maintaining a **Vertical Position** the body descends along its longitudinal axis until the toes are submerged.

0

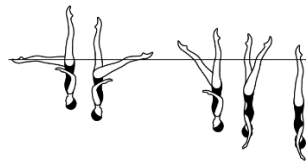


2. See BP 6 **Vertical Position** and BM 10 *Vertical Descent*. The tempo of the descent is uniform and at the same speed as the rest of the figure.

c) Continuous Spin 720°

c) **Continuous Spin 720°**: a descending Spin with a rapid rotation of: 720° (2), completed as the ankles reach the surface of the water and continues through submergence.

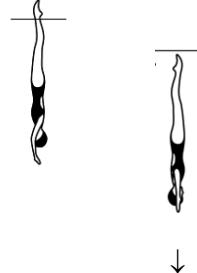
29.5



Refer to BM 17 *Helicopter Rotation* Step 1 Major Desired Actions.

2. Maintaining a **Vertical Position** the body continues its rotation and descends along its longitudinal axis until the toes are submerged.

0



2. See BP 6 **Vertical Position** and BM 10 *Vertical Descent*. The *Vertical Descent* is performed rapidly.

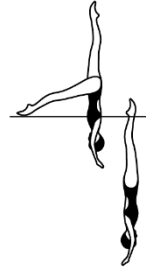
BM 17 Helicopter Rotation (cont.)

Basic Movement Description	NVT	Diagrams	Major Desired Actions
----------------------------	-----	----------	-----------------------

d) Rapid Airborne Spinning 180°

d) Rapid Airborne Spinning 180°: from an airborne **Fishtail Position** the horizontal leg is rapidly lifted while closing into the vertical leg to a **Vertical Position** during a rapid *descending Spin* with a rotation of 180° and is completed as the ankles reach the surface of the water.

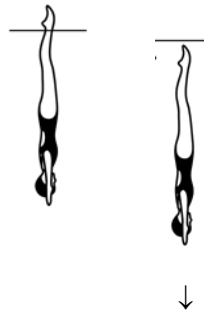
17.5



1.1 See BP 8 airborne **Fishtail Position**. The legs are rapidly joined while rapidly descending and rotating to assume a BP 6 **Vertical Position** at ankle level. This position is reached as the legs are joined and the rotation is completed.
1.2 The vertical leg maintains the vertical line throughout the rotation.
1.3 Longitudinal axis is maintained throughout the rotation.
1.4 Refer to Section BM 13 *Spins* and Spin Allowances.


2. Maintaining a **Vertical Position** the body rapidly descends along its longitudinal axis until the toes are submerged.

0



2. See BP 6 **Vertical Position** and BM 10 *Vertical Descent*. The *Vertical Descent* is performed rapidly.

BM 18 Fouetté Rotation

Basic Movement Description	NVT	Diagrams	Major Desired Actions
<p>Fouetté Rotation From a Fishtail Position with the horizontal leg leading toward the vertical leg a rapid 180° rotation is executed as the front leg bends to assume a Bent Knee Vertical Position. The bent leg rapidly extends to a Fishtail Position.</p>	19.0		<p>1.1 A rapid rotation of 180° and simultaneous bending of the horizontal leg to assume a BP 14c Bent Knee Vertical Position.</p> <p>1.2 The bent leg rapidly extends to a BP 8 Fishtail Position.</p> <p>1.3 The water level remains constant throughout.</p> <p>1.4 Vertical alignment of the vertical leg and trunk maintained throughout.</p> <p>1.5 Stability and control evident.</p> <p>1.6 Rapid uniform motion throughout.</p> <p>1.7 Longitudinal axis maintained throughout the rotation.</p>



Artistic Swimming Figures Manual

2022 – 2025

Part 2

Category I

CATEGORY I		
101	Ballet Leg Single	1.6
102	Ballet Leg Alternate	2.4
103	Submarine Ballet Leg Single	2.1
106	Straight Ballet Leg	1.6
110	Ballet Leg Double	1.6
111	Submarine Ballet Leg Double	2.2
112	Ibis	2.5
112a	Ibis ½ Twist	2.9
112b	Ibis Full Twist	3.1
112c	Ibis Twirl	3.0
112d	Ibis Spinning 180°	2.5
112e	Ibis Spinning 360°	2.6
112f	Ibis Continuous Spin (720°)	2.9
112g	Ibis Twist Spin	3.1
112h	Ibis Spin Up 180°	3.1
112i	Ibis Spin Up 360°	3.1
112j	Ibis Combined Spin (360°+360°)	3.2
113	Crane	3.7
115	Catalina	2.3
115a	Catalina ½ Twist	2.7
115b	Catalina Full Twist	2.9
115c	Catalina Twirl	2.8
115d	Catalina Spinning 180°	2.4
115e	Catalina Spinning 360°	2.4
115f	Catalina Continuous Spin (720°)	2.7

CATEGORY I		
115g	Catalina Twist Spin	2.9
115h	Catalina Spin Up 180°	2.9
115i	Catalina Spin Up 360°	3.0
115j	Catalina Combined Spin (360°+360°)	3.1
116	Catalarc	2.9
117	Catalarc Open 180°	3.0
118	Helicopter	2.0
125	Eiffel Tower	2.6
125a	Eiffel Tower ½ Twist	3.0
125b	Eiffel Tower Full Twist	3.2
125c	Eiffel Tower Twirl	3.1
125d	Eiffel Tower Spinning 180°	2.7
125e	Eiffel Tower Spinning 360°	2.7
125f	Eiffel Tower Continuous Spin (720°)	3.0
125g	Eiffel Tower Twist Spin	3.3
125h	Eiffel Tower Spin Up 180°	3.3
125i	Eiffel Tower Spin Up 360°	3.3
128	Eiffel Walk	2.7
130	Flamingo	2.4
130a	Flamingo ½ Twist	2.8
130b	Flamingo Full Twist	3.0
130c	Flamingo Twirl	2.9
130d	Flamingo Spinning 180°	2.4
130e	Flamingo Spinning 360°	2.5
130f	Flamingo Continuous Spin (720°)	2.8

CATEGORY I		
130g	Flamingo Twist Spin	3.0
130h	Flamingo Spin Up 180°	3.0
130i	Flamingo Spin Up 360°	3.0
130j	Flamingo Combined Spin (360°+360°)	3.1
140	Flamingo Bent Knee	2.3
140a	Flamingo Bent Knee ½ Twist	2.7
140b	Flamingo Bent Knee Full Twist	2.9
140c	Flamingo Bent Knee Twirl	2.8
140d	Flamingo Bent Knee Spinning 180°	2.4
140e	Flamingo Bent Knee Spinning 360°	2.4
140f	Flamingo Bent Knee Continuous Spin (720°)	2.7
140g	Flamingo Bent Knee Twist Spin	2.9
140h	Flamingo Bent Knee Spin Up 180°	2.9
140i	Flamingo Bent Knee Spin Up 360°	3.0
140j	Flamingo Bent Knee Combined Spin (360°+360°)	3.1
141	Stingray	3.1
142	Manta Ray	2.8
143	Rio	3.1
144	Rio Straight Leg	3.1
150	Knight	3.1
154	London	2.0
154j-1	London Combined Spin (360°+360°)	2.7
154j-2	London Combined Spin (720°+720°)	2.9

Figure – 101 BALLET LEG SINGLE
DIFFICULTY – 1.6

A Ballet Leg is assumed. The Ballet Leg is lowered.






					Total
NVT=	10.5	11.0	11.0	10.5	43
PV =	2.44	2.56	2.56	2.44	10

Figure Description	NVT	Diagrams	Major Desired Actions
--------------------	-----	----------	-----------------------

1. *A Ballet Leg is assumed.*



1. See BM 1 To Assume a Ballet Leg.

10.5



11.0



2. *The Ballet Leg is lowered.*

11.0



2. See BM 2 To Lower a Ballet Leg.

10.5


BP 1 Back Layout Position

Body Position Description	Diagrams	Major Desired Actions
---------------------------	----------	-----------------------

1. Body extended with face, chest, thighs and feet at the surface of the water.



1. Gives the impression that the body is stretched horizontally to its maximum. Front of the trunk will also be at the surface of the water.

2. Head (ears specifically), hips and ankles in horizontal alignment.

2. Judgement is made by checking visual points of the horizontal alignment: ears, shoulder joints, hip joints and ankles. This imaginary line should also pass through the middle of the side of the trunk.

Figure – 101 BALLET LEG SINGLE (cont.)
DIFFICULTY – 1.6
BP 14 Bent Knee Position

Body Position Description	Diagrams	Major Desired Actions
One leg bent with the toe of the bent leg in contact with the inside of the extended leg at the knee or higher.		The relationship of the toe of the bent leg to the extended leg may vary depending on the figure but should remain constant once established, and not extend in front of or behind the extended leg.

b) Bent Knee Back Layout Position

1. Body extended in **Back Layout Position**.



1. In BP 1 **Back Layout Position** ears, shoulder joints, hip joints and ankle of extended leg in line at maximum horizontal alignment.

2. The thigh of the bent leg is perpendicular to the surface of the water.

2. 90° angle between the thigh and the surface of the water, and 90° angle maintained between the thigh and the trunk. At maximum height an air pocket will be evident between the back of the thigh and calf of the bent leg and the surface of the water.

BP 3 Ballet Leg Position





Body Position Description	Diagrams	Major Desired Actions
a) Surface 1. Body in Back Layout Position . 2. One leg extended perpendicular to the surface of the water.		1. See BP 1 Back Layout Position . Ears, shoulder joints, hip joints and ankle of extended leg in line at maximum horizontal alignment. 2. 90 ° angle between the extended leg and the surface of the water and between the extended leg and the trunk with maximum horizontal alignment maintained throughout.

Figure – 101 BALLETT LEG SINGLE (cont.)
DIFFICULTY – 1.6
BM 1 To Assume a Ballet Leg/A Ballet Leg is assumed.

Basic Movement Description	NVT	Diagrams	Major Desired Actions
1. Begin in a Back Layout Position . One leg remains at the surface of the water throughout.			1. See BP 1 Back Layout Position .
2. The foot of the other leg is drawn along the inside of the extended leg to assume a Bent Knee Back Layout Position .	10.5		2. See BP 14b Bent Knee Back Layout Position . The toe of the bending leg remains in contact with the inside of the extended leg. Minimal drop in hips. Position is held only long enough to demonstrate control and accuracy.
3. The bent leg is straightened without movement of the thigh to assume a Ballet Leg Position .	11.0		3.1 See BP 3a Surface Ballet Leg Position . Height remains constant throughout the movement. 3.2 The head and trunk remain stationary throughout.

BM 2 To Lower a Ballet Leg/A Ballet Leg is lowered




Basic Movement Description	NVT	Diagrams	Major Desired Actions
1. From a Ballet Leg Position the ballet leg is bent without movement of the thigh to a Bent Knee Back Layout Position .			1. See BP 3a Surface Ballet Leg Position and BP 14b Bent Knee Back Layout Position . Height remains constant throughout the movement.
2. The toe moves along the inside of the extended leg until a Back Layout Position is assumed.	11.0		2.1 Full extension in BP 1 Back Layout Position to be achieved as the feet are joined. 2.2 The head and trunk remain stationary throughout.
	10.5		

Figure – 102 BALLET LEG ALTERNATE
DIFFICULTY – 2.4

A Ballet Leg is assumed. The Ballet Leg is lowered. Each leg is used alternately.



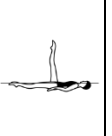

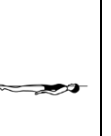
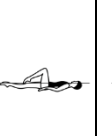
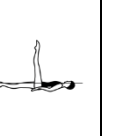
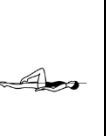
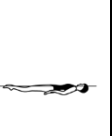









									Total
NVT=	10.5	11.0	11.0	10.5	10.5	11.0	11.0	10.5	86
PV =	1.22	1.28	1.28	1.22	1.22	1.28	1.28	1.22	10

Figure Description	NVT	Diagrams	Major Desired Actions
<p>1. A Ballet Leg is assumed.</p> <p>2. The Ballet Leg is lowered.</p> <p>Each leg is used alternately</p>			<p>1.1 See Figure 101 Ballet Leg Single BM 1 To Assume a Ballet Leg and BM 2 To Lower a Ballet Leg. Both legs should have the same height and timing during their execution.</p> <p>1.2 Pause in BP 1 Back Layout Position between each BP 3 Ballet Leg Position only long enough to define the position and to demonstrate completion of the transition.</p>
	10.5		
	11.0		
	11.0		
	10.5		
	10.5		
	10.5		
	11.0		
	10.5		
	10.5		

See Figure 101 Ballet Leg Single for **Back Layout Position, Bent Knee Back Layout Position, Ballet Leg Position, To Assume a Ballet Leg Basic Movement and To Lower a Ballet Leg Basic Movement.**

Figure – 103 SUBMARINE BALLET LEG SINGLE
DIFFICULTY – 2.1

A *Ballet Leg* is assumed. The **Ballet Leg Position** descends vertically and parallel to the surface of the water to a **Submerged Ballet Leg Position**. Maintaining the **Ballet Leg Position** parallel to the surface of the water the body rises vertically to a **Surface Ballet Leg Position**. The *Ballet Leg* is lowered.








							Total
NVT=	10.5	11.0	13.5	13.5	11.0	10.5	70
PV =	1.50	1.57	1.93	1.93	1.57	1.50	10

Figure Description	NVT	Diagrams	Major Desired Actions
--------------------	-----	----------	-----------------------

1. A *Ballet Leg* is assumed.



1. See BM 1 *To Assume a Ballet Leg*.

10.5

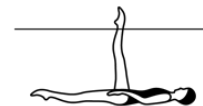


11.0






2. The **Ballet Leg Position** descends vertically and parallel to the surface of the water to a **Submerged Ballet Leg Position**.

13.5



2. See BP 3b **Submerged Ballet Leg Position**. Smooth initiation of the descent. The horizontal leg and the body are extended parallel to the surface of the water.

Figure – 103 SUBMARINE BALLET LEG SINGLE (cont.)
DIFFICULTY – 2.1

Figure Description	NVT	Diagrams	Major Desired Actions
<p>3. Maintaining the Ballet Leg Position parallel to the surface of the water the body rises vertically to a Surface Ballet Leg Position.</p>	13.5		<p>3.1 Equal timing of the descent and rise with the face and foot of the horizontal leg reaching the surface of the water simultaneously.</p> <p>3.2 The body maintains BP 3 Ballet Leg Position through the descent and rise.</p> <p>3.3 Descending and rising occur along the vertical line established by the vertical leg.</p> <p>3.4 The height of both ballet leg positions should be the same prior to the descent and after the rise back to the surface of the water.</p> <p>3.5 The Ballet Leg Position is held only long enough to define the position and to demonstrate completion of the transition before the leg is lowered to BP 1 Back Layout Position.</p>
<p>4. The <i>Ballet Leg</i> is lowered.</p>	11.0		<p>4. See BM 2 To Lower a Ballet Leg.</p>
	10.5		

BP 1 Back Layout Position



Body Position Description	Diagrams	Major Desired Actions
<p>1. Body extended with face, chest, thighs and feet at the surface of the water.</p>		<p>1. Gives the impression that the body is stretched horizontally to its maximum. Front of the trunk will also be at the surface of the water.</p>
<p>2. Head (ears specifically), hips and ankles in horizontal alignment.</p>		<p>2. Judgement is made by checking visual points of the horizontal alignment: ears, shoulder joints, hip joints and ankles. This imaginary line should also pass through the middle of the side of the trunk.</p>

Figure – 103 SUBMARINE BALLET LEG SINGLE (cont.)
DIFFICULTY – 2.1
BP 14 Bent Knee Position

Body Position Description	Diagrams	Major Desired Actions
<p>One leg bent with the toe of the bent leg in contact with the inside of the extended leg at the knee or higher.</p>		<p>The relationship of the toe of the bent leg to the extended leg may vary depending on the figure but should remain constant once established, and not extend in front of or behind the extended leg.</p>
<p>b) Bent Knee Back Layout Position</p>		
<p>1. Body extended in Back Layout Position.</p>		<p>1. In BP 1 Back Layout Position ears, shoulder joints, hip joints and ankle of extended leg in line at maximum horizontal alignment.</p>
<p>2. The thigh of the bent leg is perpendicular to the surface of the water.</p>		<p>2. 90° angle between the thigh and the surface of the water, and 90° angle maintained between the thigh and the trunk. At maximum height an air pocket will be evident between the back of the thigh and calf of the bent leg and the surface of the water.</p>

BP 3 Ballet Leg Position


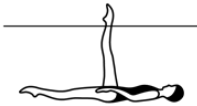



Body Position Description	Diagrams	Major Desired Actions
<p>a) Surface</p>		
<p>1. Body in Back Layout Position.</p>		<p>1. See BP 1 Back Layout Position. Ears, shoulder joints, hip joints and ankle of extended leg in line at maximum horizontal alignment.</p>
<p>2. One leg extended perpendicular to the surface of the water.</p>		<p>2. 90° angle between the extended leg and the surface of the water and between the extended leg and the trunk with maximum horizontal alignment maintained throughout.</p>
<p>b) Submerged</p>		
<p>1. Head, trunk and horizontal leg parallel to the surface of the water.</p>		<p>1. See body alignment requirements of BP 1 Back Layout Position.</p>
<p>2. One leg perpendicular to the surface of the water with the water level between the knee and the ankle.</p>		<p>2. The angles between the ballet leg and the body must remain at 90° throughout.</p>

Figure – 103 SUBMARINE BALLET LEG SINGLE (cont.)
DIFFICULTY – 2.1
BM 1 To Assume a Ballet Leg/A Ballet Leg is assumed

Basic Movement Description	NVT	Diagrams	Major Desired Actions
1. Begin in a Back Layout Position . One leg remains at the surface of the water throughout.			1. See BP 1 Back Layout Position .
2. The foot of the other leg is drawn along the inside of the extended leg to assume a Bent Knee Back Layout Position .	10.5		2. See BP 14b Bent Knee Back Layout Position . The toe of the bending leg remains in contact with the inside of the extended leg. Minimal drop in hips. Position is held only long enough to demonstrate control and accuracy.
3. The bent leg is straightened without movement of the thigh to assume a Ballet Leg Position .	11.0		3.1 See BP 3a Surface Ballet Leg Position . Height remains constant throughout the movement. 3.2 The head and trunk remain stationary throughout.

BM 2 To Lower a Ballet Leg/A Ballet Leg is lowered




Basic Movement Description	NVT	Diagrams	Major Desired Actions
1. From a Ballet Leg Position the ballet leg is bent without movement of the thigh to a Bent Knee Back Layout Position .			1. See BP 3a Surface Ballet Leg Position and BP 14b Bent Knee Back Layout Position . Height remains constant throughout the movement.
2. The toe moves along the inside of the extended leg until a Back Layout Position is assumed.	11.0		2.1 Full extension in BP 1 Back Layout Position to be achieved as the feet are joined. 2.2 The head and trunk remain stationary throughout.
	10.5		

Figure – 106 STRAIGHT BALLETT LEG
DIFFICULTY – 1.6

From a **Back Layout Position**, one leg is raised straight to a **Ballet Leg Position**. The *Ballet Leg* is lowered.





				Total
NVT=	18.5	11.0	10.5	40
PV =	4.63	2.75	2.63	10

Figure Description	NVT	Diagrams	Major Desired Actions
--------------------	-----	----------	-----------------------

1. From a **Back Layout Position**, one leg is raised straight to a **Ballet Leg Position**.

18.5



1. See BM 1B To Assume A Straight Ballet Leg.

2. The *Ballet Leg* is lowered.

11.0



2. See BM 2 To Lower a Ballet Leg.

10.5


BP 1 Back Layout Position

Body Position Description	Diagrams	Major Desired Actions
---------------------------	----------	-----------------------

1. Body extended with face, chest, thighs and feet at the surface of the water.




1. Gives the impression that the body is stretched horizontally to its maximum. Front of the trunk will also be at the surface of the water.

2. Head (ears specifically), hips and ankles in horizontal alignment.

2. Judgement is made by checking visual points of the horizontal alignment: ears, shoulder joints, hip joints and ankles. This imaginary line should also pass through the middle of the side of the trunk.

Figure – 106 STRAIGHT BALLET LEG (cont.)
DIFFICULTY – 1.6
BP 3 Ballet Leg Position

Body Position Description	Diagrams	Major Desired Actions
<p>a) Surface</p> <p>1. Body in Back Layout Position.</p> <p>2. One leg extended perpendicular to the surface of the water.</p>		<p>1. See BP 1 Back Layout Position. Ears, shoulder joints, hip joints and ankle of extended leg in line at maximum horizontal alignment.</p> <p>2. 90° angle between the extended leg and the surface of the water and between the extended leg and the trunk with maximum horizontal alignment maintained throughout.</p>

BP 14 Bent Knee Position




Body Position Description	Diagrams	Major Desired Actions
<p>One leg bent with the toe of the bent leg in contact with the inside of the extended leg at the knee or higher.</p>		<p>The relationship of the toe of the bent leg to the extended leg may vary depending on the figure but should remain constant once established, and not extend in front of or behind the extended leg.</p>
<p>b) Bent Knee Back Layout Position</p> <p>1. Body extended in Back Layout Position.</p> <p>2. The thigh of the bent leg is perpendicular to the surface of the water.</p>		<p>1. In BP 1 Back Layout Position ears, shoulder joints, hip joints and ankle of extended leg in line at maximum horizontal alignment.</p> <p>2. 90° angle between the thigh and the surface of the water, and 90° angle maintained between the thigh and the trunk. At maximum height an air pocket will be evident between the back of the thigh and calf of the bent leg and the surface of the water.</p>

Figure – 106 STRAIGHT BALLETT LEG (cont.)
DIFFICULTY – 1.6
BM 1B To Assume a Straight Ballet Leg/A Straight Ballet Leg is assumed

Basic Movement Description	NVT	Diagrams	Major Desired Actions
1. From a Back Layout Position one leg is raised straight to a Ballet Leg Position .		 	1.1 See BP 1 Back Ballet Position . Ears, shoulder joints, hip joints and ankles of extended legs at maximum horizontal alignment. 1.2 One leg is raised straight to BP 3a Surface Ballet Leg Position while keeping the horizontal alignment of the horizontal leg and trunk with minimal drop of the hips. 1.3 The head and trunk remain stationary throughout.
	18.5		

BM 2 To Lower a Ballet Leg/A Ballet Leg is lowered




Basic Movement Description	NVT	Diagrams	Major Desired Actions
1. From a Ballet Leg Position the ballet leg is bent without movement of the thigh to a Bent Knee Back Layout Position .			1. See BP 3a Surface Ballet Leg Position and BP 14b Bent Knee Back Layout Position . Height remains constant throughout the movement.
2. The toe moves along the inside of the extended leg until a Back Layout Position is assumed.	11.0		2.1 Full extension in BP 1 Back Layout Position to be achieved as the feet are joined. 2.2 The head and trunk remain stationary throughout.
	10.5		

Figure – 110 BALLET LEG DOUBLE
DIFFICULTY – 1.6

From a **Back Layout Position** with the toes remaining at the surface of the water, the shins are drawn along the surface of the water toward the chest assume a **Tub Position**. Without movement of the thighs, the legs are straightened to assume a **Surface Ballet Leg Double Position**. Without movement of the thighs, the legs are lowered to a **Tub Position**. The legs are straightened to assume a **Back Layout Position**.






					Total
NVT=	2.0	19.0	19.0	3.0	43
PV =	0.47	4.42	4.42	0.70	10

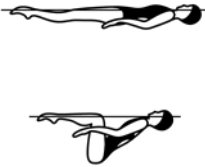
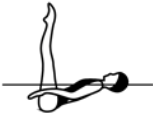




Figure Description	NVT	Diagrams	Major Desired Actions
1. From a Back Layout Position , with the toes remaining at the surface of the water, the shins are drawn along the surface of the water toward the chest to assume a Tub Position .	2.0		1. See BP 1 Back Layout Position . The shins remain at the surface of the water as the legs are drawn towards the chest. The head and trunk remain stationary as BP 15 Tub Position is assumed.
2. Without movement of the thighs, the legs are straightened to assume a Surface Ballet Leg Double Position .	19.0		2. During the extension of the legs, the thighs remain perpendicular to the surface of the water, and height remains constant. See BP 5a Surface Ballet Leg Double Position . This position is held only long enough to define the position and to demonstrate completion of the transition.
3. Without movement of the thighs, the legs are lowered to a Tub Position .	19.0		3. Height and timing remain constant throughout the lifting and lowering of the legs.
4. The legs are straightened to assume a Back Layout Position .	3.0		4.1 Full extension and maximum height in BP 1 Back Layout to be achieved simultaneously. 4.2 Head and trunk remain stationary throughout.

Figure – 110 BALLET LEG DOUBLE (cont.)
DIFFICULTY – 1.6
BP 1 Back Layout Position

Body Position Description	Diagrams	Major Desired Actions
<p>1. Body extended with face, chest, thighs and feet at the surface of the water.</p> <p>2. Head (ears specifically), hips and ankles in horizontal alignment.</p>		<p>1. Gives the impression that the body is stretched horizontally to its maximum. Front of the trunk will also be at the surface of the water.</p> <p>2. Judgement is made by checking visual points of the horizontal alignment: ears, shoulder joints, hip joints and ankles. This imaginary line should also pass through the middle of the side of the trunk.</p>

BP 15 Tub Position

Body Position Description	Diagrams	Major Desired Actions
<p>1. Legs bent and together, feet and shins at and parallel to the surface of the water with thighs perpendicular.</p> <p>2. Head in line with trunk.</p> <p>3. Face at the surface of the water.</p>		<p>1. Knee and hip joints aligned vertically with thighs perpendicular to the surface of the water. Legs dry from toes to knees.</p> <p>2. Chest close to the surface of the water, with the shoulders back. Ears, shoulder joints and hip joints aligned, with the spine extended.</p>

BP 5 Ballet Leg Double Position

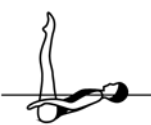
Body Position Description	Diagrams	Major Desired Actions
<p>a) Surface</p> <p>1. Legs together and extended perpendicular to the surface of the water.</p> <p>2. Head in line with the trunk.</p> <p>3. Face at the surface of the water.</p>		<p>1. Full extension of the legs at a 90° angle to the surface of the water.</p> <p>2. Chest close to the surface of the water with the shoulders back. Ears, hip joints and shoulder joints aligned, with the spine straight and extended.</p>

Figure – 111 SUBMARINE BALLET LEG DOUBLE
DIFFICULTY – 2.2

From a **Back Layout Position** with the toes at the surface of the water, the shins are drawn along the surface of the water toward the chest to assume a **Tub Position**. Without movement of the thighs, the legs are straightened to assume a **Surface Ballet Leg Double Position**. The body descends vertically to a **Submerged Ballet Leg Double Position**. The body ascends vertically to a **Surface Ballet Leg Double Position**. Without movement of the thighs, the legs are lowered to a **Tub Position**. The legs are straightened to resume a **Back Layout Position**.





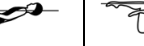


							Total
NVT=	2.0	19.0	16.0	16.0	19.0	3.0	75
PV =	0.27	2.53	2.13	2.13	2.53	0.40	10

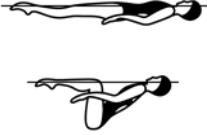
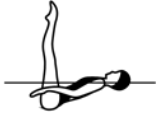
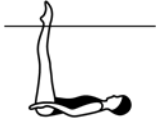

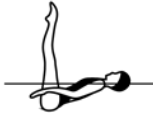


Figure Description	NVT	Diagrams	Major Desired Actions
1. From a Back Layout Position with the toes at the surface of the water, the shins are drawn along the surface of the water toward the chest to assume a Tub Position .	2.0		1.1 See BP 1 Back Layout Position . The trunk remains stationary as BP 15 Tub Position is assumed.
2. Without movement of the thighs, the legs are straightened to assume a Surface Ballet Leg Double Position .	19.0		2. See BP 5a Surface Ballet Leg Double Position . During the extension of the legs, the thighs remain perpendicular to the surface of the water, and the height remains constant. This position is held only long enough to define the position and to demonstrate completion of the transition.
3. The body descends vertically to a Submerged Ballet Leg Double Position .	16.0		3.1 Equal timing of the descent and rise with the body remaining parallel to the surface of the water. 3.2 The body maintains BP 5 Ballet Leg Double Position through the descent and rise. 3.3 Descending and ascending occur along the vertical line established and maintained by the legs. See BP 5b Submerged Ballet Leg Double Position .

Figure – 111 SUBMARINE BALLET LEG DOUBLE (cont.)
DIFFICULTY – 2.2

Figure Description	NVT	Diagrams	Major Desired Actions
3. (cont.) The body descends vertically to a Submerged Ballet Leg Double Position .	16.0		3.4 The height of both ballet leg double positions should be the same prior to the descent and after the rise back to the surface of the water.
4. The body ascends vertically to a Surface Ballet Leg Double Position .	16.0		4.1 Height at the surface is the same as prior to descending. 4.2 The Surface Ballet Leg Double Position is held only long enough to define the position and to demonstrate completion of the transition before the legs are lowered.
5. Without movement of the thighs, the legs are lowered to Tub Position .	19.0		5. Height and timing remain constant throughout the lifting and lowering actions.
6. The legs are straightened to resume a Back Layout Position	3.0		6.1 Full extension and maximum horizontal alignment in BP 1 Back Layout to be achieved simultaneously. 6.2 Head and trunk remain stationary throughout the extending of the legs.

See Figure 110 Ballet Leg Double for **Back Layout Position, Tub Position and Ballet Leg Double Position**.

BP 5 Ballet Leg Double Position

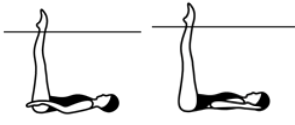
Body Position Description	Diagrams	Major Desired Actions
b) Submerged 1. Trunk and head parallel to the surface of the water. 2. 90° angle between the trunk and the extended legs. 3. Water level between knees and ankles of the extended legs.		1. Ears, shoulder joints and hip joints aligned. 2. Legs perpendicular to the surface of the water. Body extended horizontally at a 90° angle to the surface of the water.

Figure – 112 IBIS
DIFFICULTY – 2.5

A *Ballet Leg* is assumed. Maintaining this position, the body is rotated around a lateral axis through the hips to assume a **Fishtail Position**. The horizontal leg is lifted to a **Vertical Position**. A *Vertical Descent* is executed.



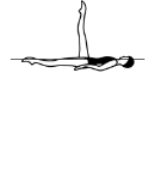

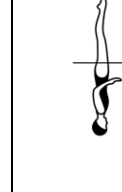
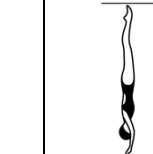
						Total
NVT=	10.5	11.0	33.0	20.5	14.0	89
PV =	1.18	1.24	3.71	2.30	1.57	10

Figure Description	NVT	Diagrams	Major Desired Actions
--------------------	-----	----------	-----------------------

1. A *Ballet Leg* is assumed. .



1. See BM 1 To Assume a *Ballet Leg*.

10.5

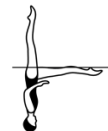
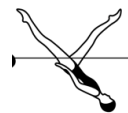


11.0





2. Maintaining this position the body is rotated around a lateral axis through the hips to assume a **Fishtail Position**.

33.0




2.1 Simultaneous lift of the leg and descent of the trunk, with foot of the non-ballet leg coming off the surface of the water as the head goes under the surface of the water.
 2.2 90° angles maintained between the ballet leg, trunk and the non-ballet leg.
 2.3 Height remains constant with hips as the pivot point.
 2.4 Head and feet reach BP 8 **Fishtail Position** simultaneously.

Figure – 112 IBIS (cont.)
DIFFICULTY – 2.5

Figure Description	NVT	Diagrams	Major Desired Actions
3. The horizontal leg is lifted to a Vertical Position .	20.5		<p>3.1 See BP 6 Vertical Position. Height is constant as the legs join, with the trunk and the vertical leg maintaining vertical alignment.</p> <p>4.2 The Vertical Position is held only long enough to define the position and to demonstrate completion of the transition prior to the <i>Vertical Descent</i>.</p>
4. A <i>Vertical Descent</i> is executed.	14.0		<p>4. See BM 10 <i>Vertical Descent</i>. The tempo of the descent is uniform and at the same speed as the rest of the figure.</p>


BP 1 Back Layout Position

Body Position Description	Diagrams	Major Desired Actions
1. Body extended with face, chest, thighs and feet at the surface of the water.		1. Gives the impression that the body is stretched horizontally to its maximum. Front of the trunk will also be at the surface of the water.
2. Head (ears specifically), hips and ankles in horizontal alignment.		2. Judgement is made by checking visual points of the horizontal alignment: ears, shoulder joints, hip joints and ankles. This imaginary line should also pass through the middle of the side of the trunk.


BP 14 Bent Knee Position

Body Position Description	Diagrams	Major Desired Actions
One leg bent with the toe of the bent leg in contact with the inside of the extended leg at the knee or higher.		The relationship of the toe of the bent leg to the extended leg may vary depending on the figure but should remain constant once established, and not extend in front of or behind the extended leg.

Figure – 112 IBIS (cont.)
DIFFICULTY – 2.5
BP 14 Bent Knee Position (cont.)

Body Position Description	Diagrams	Major Desired Actions
<p>b) Bent Knee Back Layout Position</p> <p>1. Body extended in Back Layout Position.</p> <p>2. The thigh of the bent leg is perpendicular to the surface of the water.</p>		<p>1. In BP 1 Back Layout Position ears, shoulder joints, hip joints and ankle of extended leg in line at maximum horizontal alignment.</p> <p>2. 90° angle between the thigh and the surface of the water, and 90° angle maintained between the thigh and the trunk. At maximum height an air pocket will be evident between the back of the thigh and calf of the bent leg and the surface of the water.</p>

BP 3 Ballet Leg Position

Body Position Description	Diagrams	Major Desired Actions
<p>a) Surface</p> <p>1. Body in Back Layout Position.</p> <p>2. One leg extended perpendicular to the surface of the water.</p>		<p>1. See BP 1 Back Layout Position. Ears, shoulder joints, hip joints and ankle of extended leg in line at maximum horizontal alignment.</p> <p>2. 90° angle between the extended leg and the surface of the water and between the extended leg and the trunk with maximum horizontal alignment maintained throughout.</p>

BP 8 Fishtail Position

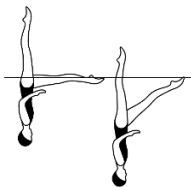

Body Position Description	Diagrams	Major Desired Actions
<p>1. Body extended in Vertical Position with one leg extended forward. The foot of the forward leg is at the surface of the water regardless of the height of the hips.</p>		<p>1. See BP 6 Vertical Position for body alignment. The foot of the forward leg must be at the surface of the water. Hip joints must be on a horizontal line.</p>

Figure – 112 IBIS (cont.)
DIFFICULTY – 2.5
BP 6 Vertical Position

Body Position Description	Diagrams	Major Desired Actions
1. Body extended perpendicular to the surface of the water; legs together, head downward.		1. Full extension of the body.
2. Head (ears specifically), hips and ankles in line.		2. Judgement is made by checking visual points of the vertical alignment: ears, shoulder joints, hip joints and ankles.

BM 1 To Assume a Ballet Leg/A Ballet Leg is assumed




Basic Movement Description	NVT	Diagrams	Major Desired Actions
1. Begin in a Back Layout Position . One leg remains at the surface of the water throughout.			1. See BP 1 Back Layout Position .
2. The foot of the other leg is drawn along the inside of the extended leg to assume a Bent Knee Back Layout Position .	10.5		2. See BP 14b Bent Knee Back Layout Position . The toe of the bending leg remains in contact with the inside of the extended leg. Minimal drop in hips. Position is held only long enough to demonstrate control and accuracy.
3. The bent leg is straightened without movement of the thigh to assume a Ballet Leg Position .	11.0		3.1 See BP 3a Surface Ballet Leg Position . Height remains constant throughout the movement. 3.2 The head and trunk remain stationary throughout.

Figure – 112 IBIS (cont.)
DIFFICULTY – 2.5
BM 10 Vertical Descent

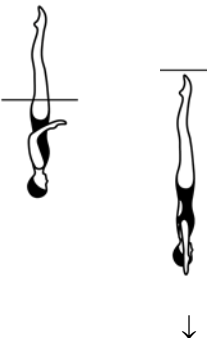
Basic Movement Description	NVT	Diagrams	Major Desired Actions
1. Maintaining a Vertical Position the body descends along its longitudinal axis until the toes are submerged.	14.0		1. See BP 6 Vertical Position . The tempo of the descent is uniform and at the same speed as the rest of the figure.

Figure – 112 IBIS (cont.)

Ibis 112a – 112g, 112j – An Ibis is executed to **Vertical Position**. The designated *Twist* or *Spin* is executed.

Note: Refer to Section BM 12 Twists & Twist Allowances and Section BM 13 Spins & Spin Allowances.

Figure – 112a IBIS ½ TWIST
DIFFICULTY – 2.9


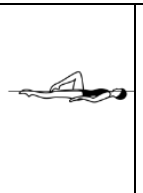
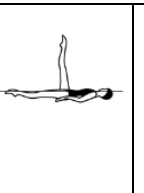
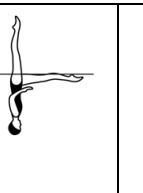
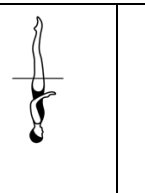
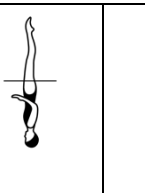
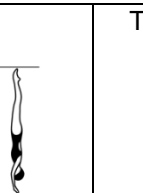
							Total
NVT=	10.5	11.0	33.0	20.5	21.0	14.0	110
PV =	0.95	1.0	3.0	1.86	1.91	1.27	10

Figure – 112b IBIS FULL TWIST
DIFFICULTY – 3.1


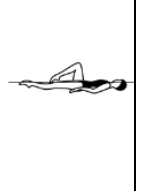
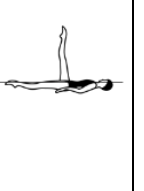
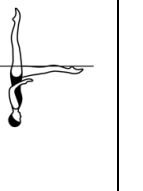
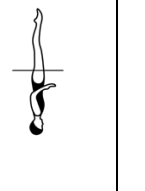
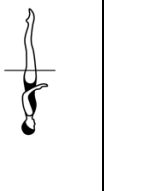
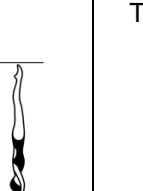
							Total
NVT=	10.5	11.0	33.0	20.5	32.0	14.0	121
PV =	0.87	0.91	2.73	1.69	2.64	1.16	10

Figure – 112 IBIS (cont.)

Ibis 112a – 112g, 112j – An Ibis is executed to **Vertical Position**. The designated *Twist* or *Spin* is executed.

Note: Refer to Section BM 12 Twists & Twist Allowances and Section BM 13 Spins & Spin Allowances.

Figure – 112c IBIS TWIRL
DIFFICULTY – 3.0

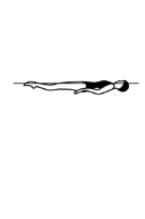
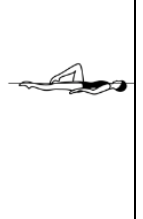
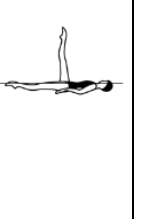
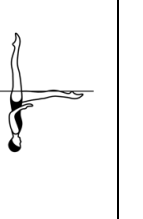
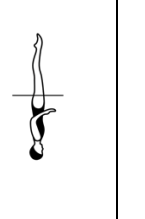
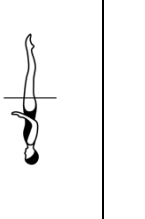
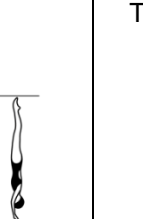
							Total
NVT=	10.5	11.0	33.0	20.5	26.0	14.0	115
PV =	0.91	0.96	2.87	1.78	2.26	1.22	10

Figure – 112d IBIS SPINNING 180°
DIFFICULTY – 2.5

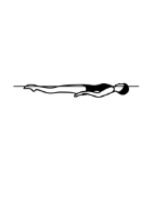
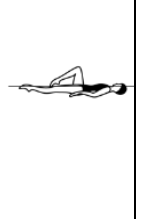
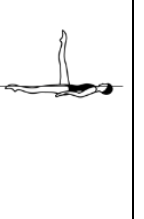
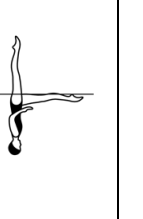
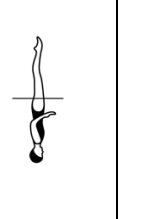
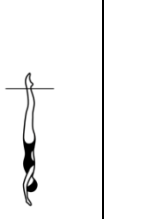
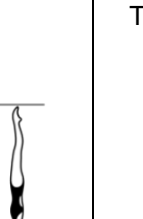
							Total
NVT=	10.5	11.0	33.0	20.5	16.0	0	91
PV =	1.15	1.21	3.63	2.25	1.76	0	10

Figure – 112e IBIS SPINNING 360°
DIFFICULTY – 2.6


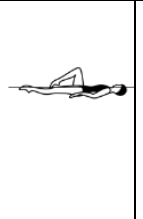
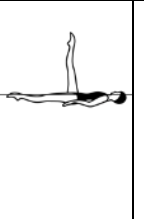
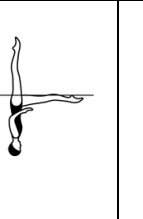
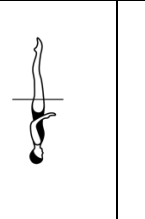
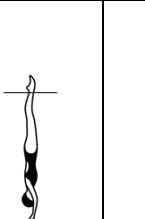
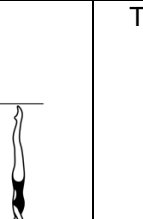
							Total
NVT=	10.5	11.0	33.0	20.5	19.0	0	94
PV =	1.12	1.17	3.51	2.18	2.02	0	10

Figure – 112 IBIS (cont.)

Ibis 112a – 112g, 112j – An Ibis is executed to **Vertical Position**. The designated *Twist* or *Spin* is executed.

Note: Refer to Section BM 12 Twists & Twist Allowances and Section BM 13 Spins & Spin Allowances.

Figure – 112f IBIS CONTINUOUS SPIN (720°)
DIFFICULTY – 2.9

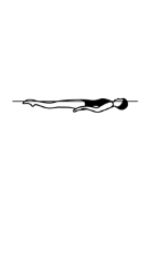
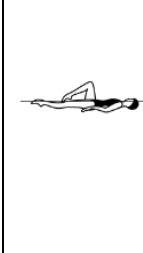
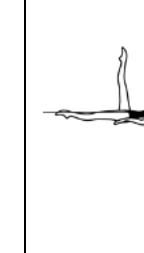
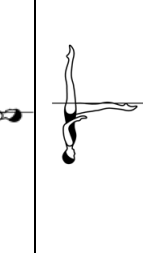
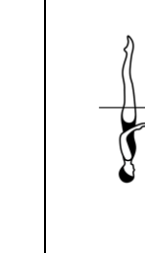
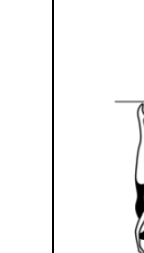
						Total
NVT=	10.5	11.0	33.0	20.5	34.0	109
PV =	0.96	1.01	3.03	1.88	3.12	10

Figure – 112g IBIS TWIST SPIN
DIFFICULTY – 3.1



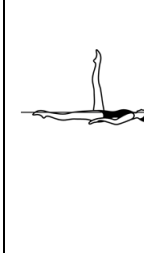
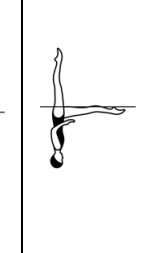
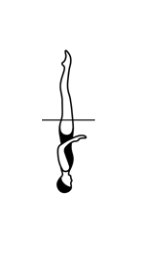
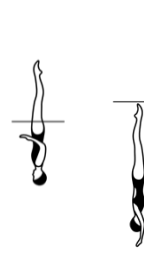
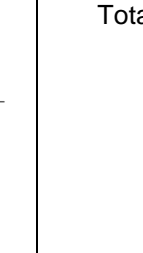

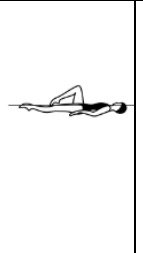
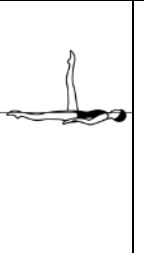
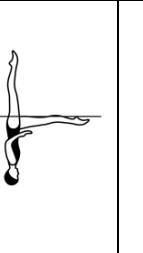
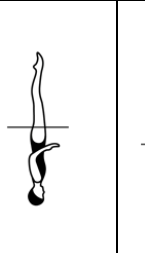
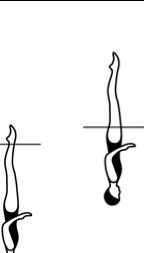
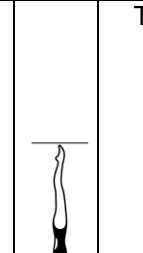
							Total
NVT=	10.5	11.0	33.0	20.5	48.0		123
PV =	0.85	0.89	2.68	1.67	3.90		10

Figure – 112j IBIS COMBINED SPIN (360° + 360°) *
DIFFICULTY – 3.2

							Total
NVT=	10.5	11.0	33.0	20.5	40.0	14.0	129
PV =	0.81	0.85	2.56	1.59	3.10	1.09	10

***Note:** Refer to Section BM 13 Spins. There is no Spin Allowance for Combined Spins.

Figure – 112 IBIS (cont.)

Ibis 112h and 112i – An Ibis is executed to **Vertical Position**. A *Vertical Descent* is executed to ankle level. The designated *ascending Spin* is executed.

Note: Refer to Section BM 13 Spins & Spin Allowances.

Figure – 112h IBIS SPIN UP 180°

DIFFICULTY – 3.1





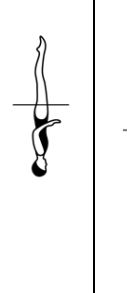
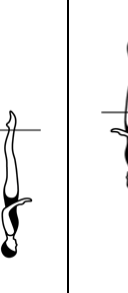
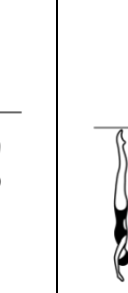
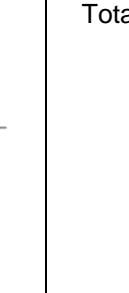
								Total
NVT=	10.5	11.0	33.0	20.5	14.0	20.0	14.0	123
PV =	0.85	0.89	2.68	1.67	1.14	1.63	1.14	10

Figure – 112i IBIS SPIN UP 360°

DIFFICULTY – 3.1




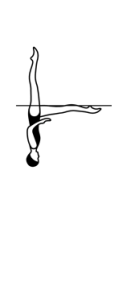
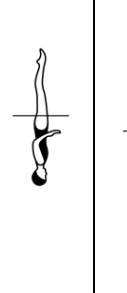
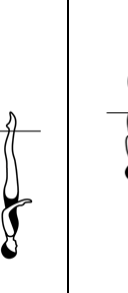
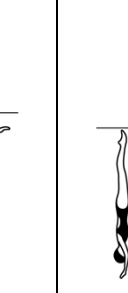
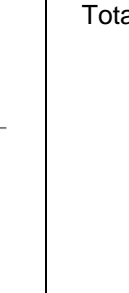
								Total
NVT=	10.5	11.0	33.0	20.5	14.0	21.0	14.0	124
PV =	0.85	0.89	2.66	1.65	1.13	1.69	1.13	10

Figure – 113 CRANE
DIFFICULTY – 3.7

A *Ballet Leg* is assumed. Maintaining this position the body is rotated around a lateral axis through the hips to assume a **Fishtail Position**. A *Half Twist* is executed in the **Fishtail Position**. The horizontal leg is lifted to **Vertical Position**. Another *Half Twist* is executed in **Vertical Position** in the same direction and at the same height. The legs are lowered to a **Surface Arch Position** and with continuous movement an *Arch to Back Layout Finish Action* is executed.







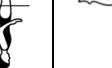


									Total
NVT=	10.5	11.0	33.0	17.0	20.5	21.0	37.0	7.0	157
PV =	0.67	0.70	2.10	1.08	1.31	1.34	2.36	0.45	10





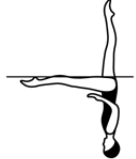


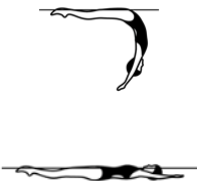
Figure Description	NVT	Diagrams	Major Desired Actions
1. A <i>Ballet Leg</i> is assumed.			1. See BM 1 To Assume a <i>Ballet Leg</i> .
	10.5		
	11.0		
2. Maintaining this position the body is rotated around a lateral axis through the hips to assume a Fishtail Position .			2.1 Simultaneous lift of the leg and descent of the trunk, with the foot of the non-ballet leg coming off the surface of the water as the head goes under the surface of the water. 2.2 90° angles maintained between the ballet leg, the trunk and the non-ballet leg. 2.3 Height remains constant with the hips as the pivot point. 2.4 Head and feet reach BP 8 Fishtail Position simultaneously.
	33.0		
3. A <i>Half Twist</i> is executed in the Fishtail Position .			3.1 See BM 12 <i>Twists</i> . The <i>Half Twist</i> is performed in a BP 8 Fishtail Position . 3.2 The foot of the non-ballet leg remains at the surface of the water throughout the <i>Half Twist</i> .
	17.0		

Figure – 113 CRANE (cont.)
DIFFICULTY – 3.7

Figure Description	NVT	Diagrams	Major Desired Actions
4. The horizontal leg is lifted to a Vertical Position .	20.5		<p>4.1 See BP 6 Vertical Position. Height is constant as the legs join, with the trunk and the vertical leg maintaining vertical alignment.</p> <p>4.2 The Vertical Position is held only long enough to define the position and to demonstrate completion of the transition prior to <i>Twist</i>.</p>
5. Another <i>Half Twist</i> is executed in Vertical Position in the same direction and at the same height.	21.0		<p>5. See BM 12 <i>Twists</i>. The second <i>Half Twist</i> is performed in BP 6 Vertical Position. Both twists rotate around the same longitudinal axis.</p>
6. The legs are lowered to a Surface Arch Position and with continuous movement an <i>Arch to Back Layout</i> is executed.	37.0 7.0		<p>6. Simultaneous lowering of the legs and arching of the back. No pause in BP 13 Surface Arch Position, however an accurate Surface Arch must be evident before the body begins to straighten. See BM 5 <i>Arch to Back Layout Position</i>.</p>

Note: Refer to Section BM 12 Twists & Twist Allowances
BP 1 Back Layout Position




Body Position Description	Diagrams	Major Desired Actions
1. Body extended with face, chest, thighs and feet at the surface of the water.		1. Gives the impression that the body is stretched horizontally to its maximum. Front of the trunk will also be at the surface of the water.
2. Head (ears specifically), hips and ankles in horizontal alignment.		2. Judgement is made by checking visual points of the horizontal alignment: ears, shoulder joints, hip joints and ankles. This imaginary line should also pass through the middle of the side of the trunk.

Figure – 113 CRANE (cont.)
DIFFICULTY – 3.7
BP 14 Bent Knee Position

Body Position Description	Diagrams	Major Desired Actions
<p>One leg bent with the toe of the bent leg in contact with the inside of the extended leg at the knee or higher.</p>		<p>The relationship of the toe of the bent leg to the extended leg may vary depending on the figure but should remain constant once established, and not extend in front of or behind the extended leg.</p>
<p>b) Bent Knee Back Layout Position</p>		
<p>1. Body extended in Back Layout Position.</p> <p>2. The thigh of the bent leg is perpendicular to the surface of the water.</p>		<p>1. In BP 1 Back Layout Position ears, shoulder joints, hip joints and ankle of extended leg in line at maximum horizontal alignment.</p> <p>2. 90° angle between the thigh and the surface of the water, and 90° angle maintained between the thigh and the trunk. At maximum height an air pocket will be evident between the back of the thigh and calf of the bent leg and the surface of the water.</p>

BP 3 Ballet Leg Position


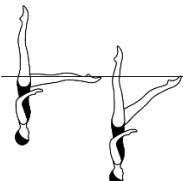

Body Position Description	Diagrams	Major Desired Actions
<p>a) Surface</p>		
<p>1. Body in Back Layout Position.</p> <p>2. One leg extended perpendicular to the surface of the water.</p>		<p>1. See BP 1 Back Layout Position. Ears, shoulder joints, hip joints and ankle of extended leg in line at maximum horizontal alignment.</p> <p>2. 90 ° angle between the extended leg and the surface of the water and between the extended leg and the trunk with maximum horizontal alignment maintained throughout.</p>

Figure – 113 CRANE (cont.)
DIFFICULTY – 3.7
BP 8 Fishtail Position

Body Position Description	Diagrams	Major Desired Actions
<p>1. Body extended in Vertical Position with one leg extended forward. The foot of the forward leg is at the surface of the water regardless of the height of the hips.</p>		<p>1. See BP 6 Vertical Position for body alignment. The foot of the forward leg must be at the surface of the water. Hip joints must be on a horizontal line.</p>

BP 6 Vertical Position

Body Position Description	Diagrams	Major Desired Actions
<p>1. Body extended perpendicular to the surface of the water; legs together, head downward.</p> <p>2. Head (ears specifically), hips and ankles in line.</p>		<p>1. Full extension of the body.</p> <p>2. Judgement is made by checking visual points of the vertical alignment: ears, shoulder joints, hip joints and ankles.</p>

BP 13 Surface Arch Position





Body Position Description	Diagrams	Major Desired Actions
<p>1. Lower back arched with hips, shoulders and head on a vertical line.</p> <p>2. Legs together and at the surface of the water.</p>		<p>1. Hip joints and shoulder joints on a horizontal line with both of these alignments 'square' and parallel to one another. Head (ears specifically) in line with shoulders.</p> <p>2. Hips joints at the surface of the water.</p>

Figure – 113 CRANE (cont.)
DIFFICULTY – 3.7
BM 1 To Assume a Ballet Leg/A Ballet Leg is assumed

Basic Movement Description	NVT	Diagrams	Major Desired Actions
1. Begin in a Back Layout Position . One leg remains at the surface of the water throughout.			1. See BP 1 Back Layout Position .
2. The foot of the other leg is drawn along the inside of the extended leg to assume a Bent Knee Back Layout Position .	10.5		2. See BP 14b Bent Knee Back Layout Position . The toe of the bending leg remains in contact with the inside of the extended leg. Minimal drop in hips. This position is held only long enough to define the position and to demonstrate completion of the transition.
3. The bent leg is straightened without movement of the thigh to assume a Ballet Leg Position .	11.0		3.1 See BP 3a Surface Ballet Leg Position . Height remains constant throughout the movement. 3.2 The head and trunk remain stationary throughout.

BM 12 Twists a) Half Twist in Fishtail Position – adapted

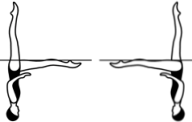
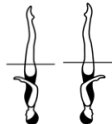
Basic Movement Description	NVT	Diagrams	Major Desired Actions
1. A <i>Twist</i> is a rotation at a sustained height.			1. Height remains constant throughout the rotation. Stability and alignment of the position is evident before, during and upon completion of the <i>Twist</i> . The amount of height is judged by the relationship of the hip joints to the surface of the water with maximum height desirable.
2. The body remains on its longitudinal axis throughout the rotation.			2. The longitudinal axis runs through the centre of the body and is perpendicular to the surface of the water. On the spot rotation around this axis.
Half Twist in Fishtail Position			
4. a) Half Twist : a <i>Twist</i> of 180°.	17.0		4.1 See Twist Allowance. The first <i>Half Twist</i> is performed in a BP 8 Fishtail Position . 4.2 Foot of the non-ballet leg remains at the surface of the water throughout the <i>Half</i>

Figure – 113 CRANE (cont.)
Twist.
DIFFICULTY – 3.7
BM 12 Twists a) Half Twist

Basic Movement Description	NVT	Diagrams	Major Desired Actions
4. Another <i>Half Twist</i> is executed in Vertical Position in the same direction and at the same height.	21.0		4. See Twist Allowance. The second <i>Half Twist</i> is performed in BP 6 Vertical Position .

BM 5 Arch to Back Layout Finish Action

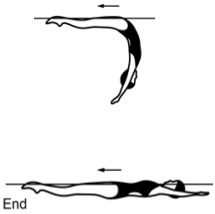
Basic Movement Description	NVT	Diagrams	Major Desired Actions
1. From a Surface Arch Position the hips, chest and face surface sequentially at the same point with foot first movement to a Back Layout Position until the head occupies the position of the hips at the beginning of this action.	7.0		1. See BP 13 Surface Arch Position . Sharp arch in lower back. The body rises, straightens and moves along the surface of the water with a stationary BP 1 Back Layout Position achieved as the face surfaces. Full extension maintained throughout.

Figure – 115 CATALINA
DIFFICULTY – 2.3

A *Ballet Leg* is assumed. A *Catalina Rotation* is executed. The horizontal leg is lifted to **Vertical Position**. A *Vertical Descent* is executed.




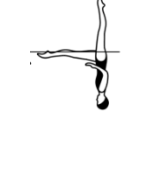
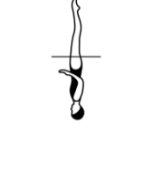
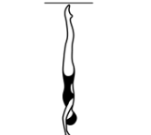
						Total
NVT=	10.5	11.0	24.0	20.5	14.0	80
PV =	1.31	1.38	3.00	2.56	1.75	10




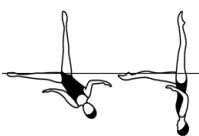




Figure Description	NVT	Diagrams	Major Desired Actions
1. A <i>Ballet Leg</i> is assumed.			1. See BM 1 <i>To Assume a Ballet Leg</i> .
	10.5		
	11.0		
2. A <i>Catalina Rotation</i> is executed.			2. See BM 7 <i>Catalina Rotation</i> .
	24.0		
3. The horizontal leg is lifted to Vertical Position .			3.1 See BP Vertical Position . Height remains constant as the legs join, with the head, trunk and the vertical leg maintaining vertical alignment. 3.2 The Vertical Position is position is held only long enough to define the position and to demonstrate completion of the transition prior to the descent.
	20.5		
4. A <i>Vertical Descent</i> is executed.			4. See BM 10 <i>Vertical Descent</i> .
	14.0		

Figure – 115 CATALINA (cont.)
DIFFICULTY – 2.3
BP 1 Back Layout Position

Body Position Description	Diagrams	Major Desired Actions
<p>1. Body extended with face, chest, thighs and feet at the surface of the water.</p> <p>2. Head (ears specifically), hips and ankles in horizontal alignment.</p>		<p>1. Gives the impression that the body is stretched horizontally to its maximum. Front of the trunk will also be at the surface of the water.</p> <p>2. Judgement is made by checking visual points of the horizontal alignment: ears, shoulder joints, hip joints and ankles. This imaginary line should also pass through the middle of the side of the trunk.</p>

BP 14 Bent Knee Position

Body Position Description	Diagrams	Major Desired Actions
<p>One leg bent with the toe of the bent leg in contact with the inside of the extended leg at the knee or higher.</p> <p>b) Bent Knee Back Layout Position</p> <p>1. Body extended in Back Layout Position.</p> <p>2. The thigh of the bent leg is perpendicular to the surface of the water.</p>		<p>The relationship of the toe of the bent leg to the extended leg may vary depending on the figure but should remain constant once established, and not extend in front of or behind the extended leg.</p> <p>1. In BP 1 Back Layout Position ears, shoulder joints, hip joints and ankle of extended leg in line at maximum horizontal alignment.</p> <p>2. 90° angle between the thigh and the surface of the water, and 90° angle maintained between the thigh and the trunk. At maximum height an air pocket will be evident between the back of the thigh and calf of the bent leg and the surface of the water.</p>

BP 3 Ballet Leg Position


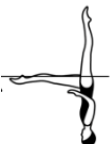
Body Position Description	Diagrams	Major Desired Actions
<p>a) Surface</p> <p>1. Body in Back Layout Position.</p>		<p>1. See BP 1 Back Layout Position. Ears, shoulder joints, hip joints and ankle of extended leg in line at maximum horizontal alignment.</p>


Figure – 115 CATALINA (cont.)
DIFFICULTY – 2.3
BP 3 Ballet Leg Position (cont.)

Body Position Description	Diagrams	Major Desired Actions
2. One leg extended perpendicular to the surface of the water.		2. 90° angle between the extended leg and the surface of the water and between the extended leg and the trunk with maximum horizontal alignment maintained throughout.

BP 8 Fishtail Position

Body Position Description	Diagrams	Major Desired Actions
1. Body extended in Vertical Position with one leg extended forward. The foot of the forward leg is at the surface of the water regardless of the height of the hips.		1. See BP 6 Vertical Position for body alignment. The foot of the forward leg must be at the surface of the water. Hip joints must be on a horizontal line.

BP 6 Vertical Position

Body Position Description	Diagrams	Major Desired Actions
1. Body extended perpendicular to the surface of the water; legs together, head downward.		1. Full extension of the body.
2. Head (ears specifically), hips and ankles in line.		2. Judgement is made by checking visual points of the vertical alignment: ears, shoulder joints, hip joints and ankles.

BM 1 To Assume a Ballet Leg/A Ballet Leg is assumed




Basic Movement Description	NVT	Diagrams	Major Desired Actions
1. Begin in a Back Layout Position . One leg remains at the surface of the water throughout.			1. See BP 1 Back Layout Position .
2. The foot of the other leg is drawn along the inside of the extended leg to assume a Bent Knee Back Layout Position .	10.5		2. See BP 14b Bent Knee Back Layout Position . The toe of the bending leg remains in contact with the inside of the extended leg. Minimal drop in hips. Position is held only long enough to demonstrate control and accuracy.

Figure – 115 CATALINA (cont.)
DIFFICULTY – 2.3
BM 1 To Assume a Ballet Leg/A Ballet Leg is assumed (cont.)

Basic Movement Description	NVT	Diagrams	Major Desired Actions
3. The bent leg is straightened without movement of the thigh to assume a Ballet Leg Position .	11.0		3.1 See BP 3a Surface Ballet Leg Position . Height remains constant throughout the movement. 3.2 The head and trunk remain stationary throughout.

BM 7 Catalina Rotation


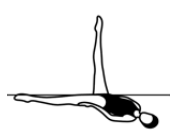

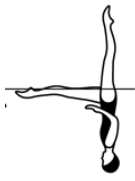
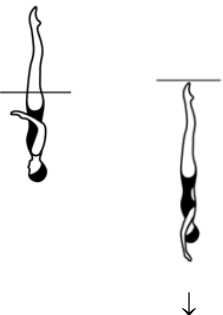
Basic Movement Description	NVT	Diagrams	Major Desired Actions
1. From a Ballet Leg Position a rotation of the body is initiated.	24.0		1. See BP 3 Ballet Leg Positions .
2. The head, shoulders and trunk begin the rotation at the surface of the water while descending without lateral movement to a Fishtail Position .		 	2.1 Rotation begins no later than when the nose goes beneath the surface of the water. 2.2 Simultaneous rotation and descent of the trunk along the vertical line established by the vertical leg. 2.3 At the halfway point, the body is in a tilted 'Y' position, with the trunk at a 45° angle to the surface of the water, and the head, trunk and legs face forward. 2.4 Height and uniform motion throughout. 2.5 See BP 8 Fishtail Position .
3. The vertical leg remains perpendicular to the surface of the water while the foot of the horizontal leg remains at the surface of the water throughout the rotation. Unless otherwise specified, <i>Catalina Rotation</i> starts from a Ballet Leg Position .			3. Each leg rotates around its respective horizontal or vertical axis simultaneously with each other and during the rotation of the descending trunk.

Figure – 115 CATALINA (cont.)

BM 10 Vertical Descent

Basic Movement Description	NVT	Diagrams	Major Desired Actions
1. Maintaining a Vertical Position the body descends along its longitudinal axis until the toes are submerged.	14.0		1. See BP 6 Vertical Position . The tempo of the descent is uniform and at the same speed as the rest of the figure.

Catalina 115a – 115g, 115j – A Catalina is executed to **Vertical Position**. The designated *Twist* or *Spin* is executed.

Note: Refer to Section BM 12 Twists & Twist Allowances and Section BM 13 Spins and Spin Allowances.

Figure – 115a CATALINA ½ TWIST

DIFFICULTY – 2.7








							Total
NVT=	10.5	11.0	24.0	20.5	21.0	14.0	101
PV =	1.04	1.09	2.38	2.03	2.08	1.39	10

Figure – 115b CATALINA FULLTWIST

DIFFICULTY – 2.9











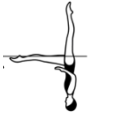
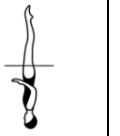
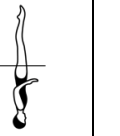
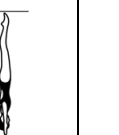
							Total
NVT=	10.5	11.0	24.0	20.5	32.0	14.0	112
PV =	0.94	0.98	2.14	1.83	2.86	1.25	10

Figure – 115 CATALINA (cont.)
Figure – 115c CATALINA TWIRL
DIFFICULTY – 2.8

								Total
NVT=	10.5	11.0	24.0	20.5	26.0	14.0		106
PV =	0.99	1.04	2.26	1.93	2.45	1.32		10

Catalina 115a – 115g, 115j – A Catalina is executed to **Vertical Position**. The designated *Twist* or *Spin* is executed.

Note: Refer to Section BM 12 Twists & Twist Allowances and Section BM 13 Spins and Spin Allowances.

Figure – 115d CATALINA SPINNING 180°
DIFFICULTY – 2.4





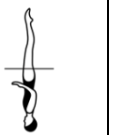
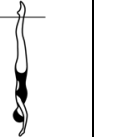

								Total
NVT=	10.5	11.0	24.0	20.5	16.0	0		82
PV =	1.28	1.34	2.93	2.50	1.95	0		10

Figure – 115e CATALINA SPINNING 360°
DIFFICULTY – 2.4





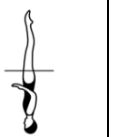
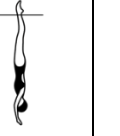
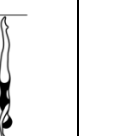
								Total
NVT=	10.5	11.0	24.0	20.5	19.0	0		85
PV =	1.24	1.29	2.82	2.41	2.24	0		10

Figure – 115f CATALINA CONTINUOUS SPIN (720°)
DIFFICULTY – 2.7




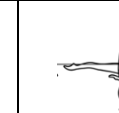
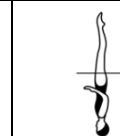
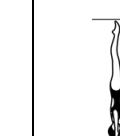
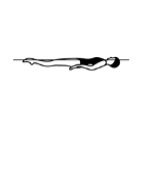
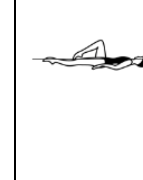
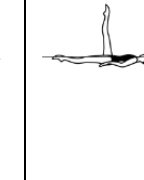
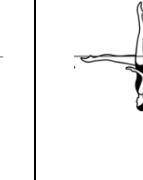
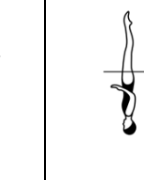
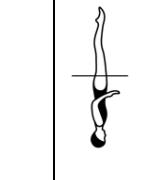
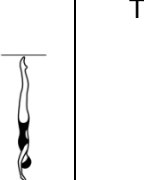
							Total
NVT=	10.5	11.0	24.0	20.5	34.0		100
PV =	1.05	1.10	2.40	2.05	3.40		10

Figure – 115 CATALINA (cont.)

Figure – 115g CATALINA TWIST SPIN

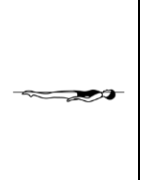
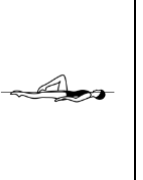
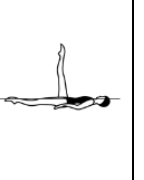
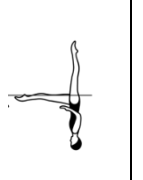
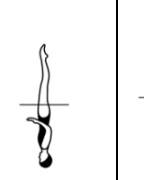
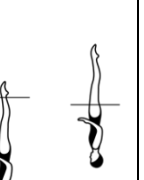
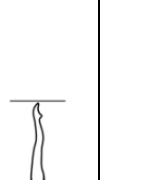

DIFFICULTY – 2.9

							Total
NVT=	10.5	11.0	24.0	20.5	48.0		114
PV =	0.92	0.96	2.11	1.80	4.21		10

Catalina 115a – 115g, 115j – A Catalina is executed to **Vertical Position**. The designated *Twist or Spin* is executed.

Figure – 115j CATALINA COMBINED SPIN (360° + 360°)*

DIFFICULTY – 3.1

								Total
NVT=	10.5	11.0	24.0	20.5	40.0	14.0		120
PV =	0.88	0.92	2.00	1.71	3.33	1.17		10

***Note: Refer to Section BM 13 Spins. There is no Spin Allowance for Combined Spins.**

Catalina 115h and 115i – A Catalina is executed to **Vertical Position**. A *Vertical Descent* is executed to ankle level. The designated *ascending Spin* is executed.

Note: Refer to Section BM 13 Spins and Spin Allowances.

Figure – 115h CATALINA SPIN UP 180°

DIFFICULTY – 2.9




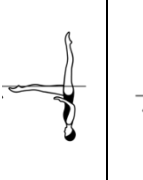
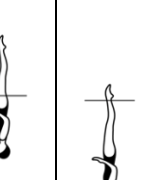
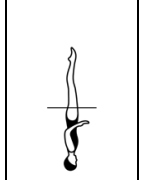
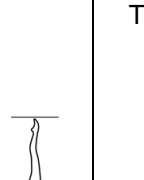
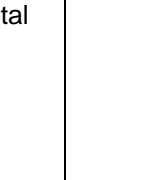
								Total
NVT=	10.5	11.0	24.0	20.5	14.0	20.0	14.0	114
PV =	0.92	0.96	2.11	1.80	1.23	1.75	1.23	10

Figure – 115 CATALINA (cont.)

Catalina 115h and 115i – A Catalina is executed to **Vertical Position**. A *Vertical Descent* is executed to ankle level. The designated *ascending Spin* is executed.

Note: Refer to Section BM 13 Spins and Spin Allowances.

Figure – 115i CATALINA SPIN UP 360
DIFFICULTY – 3.0

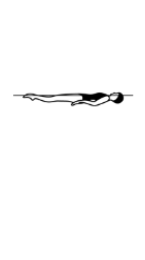

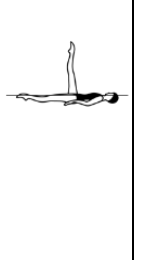
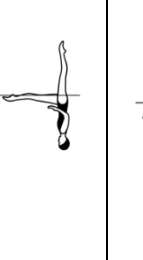
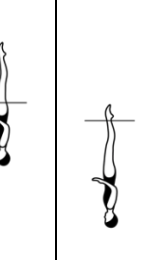
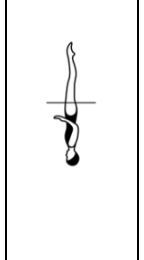
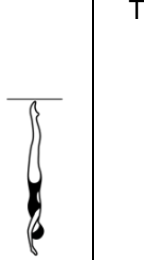
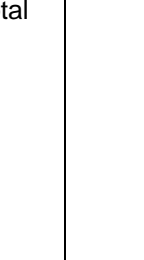
								Total
NVT=	10.5	11.0	24.0	20.5	14.0	21.0	14.0	115
PV =	0.91	0.96	2.09	1.78	1.22	1.83	1.22	10

Figure – 116 CATALARC
DIFFICULTY – 2.9

A *Ballet Leg* is assumed. A *Catalina Rotation* is executed. The horizontal leg is lifted in a 180° arc over the surface of the water. As it passes the vertical leg; the vertical leg moves symmetrically in the opposite direction to assume a **Split Position**. A *Walkout Front* is executed.

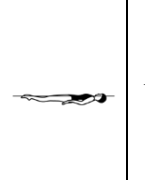
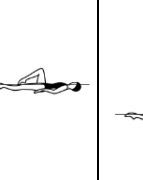
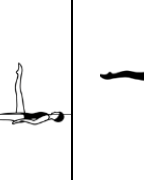
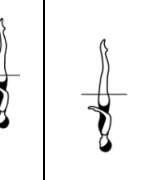
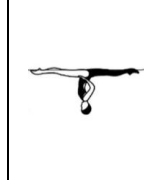

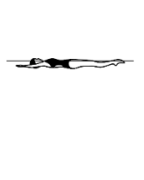

								Total
NVT=	10.5	11.0	24.0	20.5	17.0	23.0	7.0	113
PV =	0.93	0.97	2.12	1.81	1.50	2.04	0.62	10

Figure Description	NVT	Diagrams	Major Desired Actions
--------------------	-----	----------	-----------------------

1. A *Ballet Leg* is assumed.



1. See Figure 115 Catalina BM 1 To Assume a *Ballet Leg*.


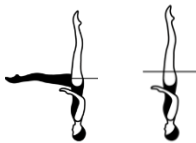

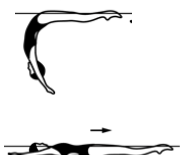
10.5



11.0



Figure – 116 CATALARC (cont.)
DIFFICULTY – 2.9



Figure Description	NVT	Diagrams	Major Desired Actions
2. A <i>Catalina Rotation</i> is executed.	24.0		2. See 115 Catalina BM 7 <i>Catalina Rotation</i> .
3. The horizontal leg is lifted in a 180° arc over the surface of the water. As it passes the vertical leg, the vertical leg moves symmetrically in the opposite direction to assume a Split Position .	20.5		3.1 Height is maintained throughout the lift and pass through of the legs. 3.2 The arcing leg moves continuously at a uniform speed with no pause as the legs pass the vertical. The vertical leg moves at the same speed as the arcing leg. 3.3 From the vertical position to BP 16a Surface Split Position both legs are always equidistant from the surface of the water and both reach the surface of the water simultaneously. 3.4 Tempo of the leg raise to vertical is same as the lowering to Split Position . 3.5 The horizontal leg becomes the back leg in the BP 16a Surface Split Position .
It is important to note that the horizontal leg in the Fishtail Position must become the back leg in the Split Position .	17.0		
The diagram shows the Fishtail Position to Split Position movement performed with the left (L) leg shaded black however either leg can be used to perform the action.			
4. A <i>Walkout Front</i> is executed.	23.0		4. See BM 6a <i>Walkout Front</i> and see BM 5 <i>Arch to Back Layout Position</i> .
	7.0		

See Figure 115 Catalina for **Back Layout Position, Bent Knee Back Layout Position, Ballet Leg Position, Fishtail Position, To Assume a Ballet Leg Basic Movement** and *Catalina Rotation Basic Movement*.


BP 16 Split Position

Body Position Description	Diagrams	Major Desired Actions
1. Legs evenly split forward and back. 2. The legs are parallel to the surface of the water.		1. Full extension of the legs at or above the surface of the water.

Figure – 116 CATALARC (cont.)
DIFFICULTY – 2.9
BP 16 Split Position (cont.)

Body Position Description	Diagrams	Major Desired Actions
<p>3. Lower back arched, with hips, shoulders and head on a vertical line.</p> <p>4. 180° angle between the extended legs (flat split), with inside of each leg aligned on opposite sides of a horizontal line, regardless of the height of the hips.</p>		<p>4. Flat split. Hip joints and shoulder joints on a horizontal line, with both of these alignments 'square' and parallel to each other.</p>
<p>a) Surface Split Position</p> <p>1. Legs are dry at the surface of the water.</p>		<p>1. Full extension of the legs. Crotch and legs dry at the surface of the water.</p>

BP 13 Surface Arch Position

Body Position Description	Diagrams	Major Desired Actions
<p>1. Lower back arched with hips, shoulders and head on a vertical line.</p>		<p>1. Hip joints and shoulder joints on a horizontal line with both of these alignments 'square' and parallel to one another. Head (ears specifically) in line with shoulders.</p>
<p>2. Legs together and at the surface of the water.</p>		<p>2. Hips joints at the surface of the water.</p>

BM 6 Walkout


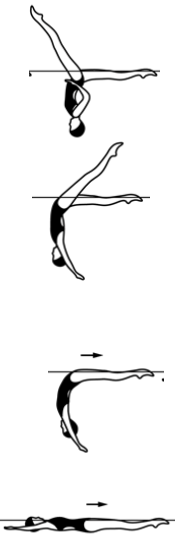
Basic Movement Description	NVT	Diagrams	Major Desired Actions
<p>1. These movements start in a Split Position unless otherwise specified in the figure description. The hips remain stationary as one leg is lifted in an arc over the surface of the water to meet the opposite leg.</p>			<p>1. See BP 16a Surface Split Position.</p>

Figure – 116 CATALARC (cont.)
DIFFICULTY – 2.9
BM 6 Walkout (cont.)

Basic Movement Description	NVT	Diagrams	Major Desired Actions
a) Walkout Front 2. The front leg is lifted in a 180° arc over the surface of the water to meet the opposite leg in a Surface Arch Position and with continuous movement an <i>Arch to Back Layout Finish Action</i> is executed.	23.0 7.0		2.1 Hip height remains constant and at the surface of the water. 2.2 Arcing leg moves continuously with uniform motion. 2.3 Both legs maintain full extension. 2.4 The trunk remains stationary until the feet join. 2.5 No pause in BP 13 Surface Arch Position , however an accurate surface arch must be evident before the body begins to rise and straighten. 2.6 Foot first surfacing motion begins when the feet are joined. 2.7 See BP 13 Surface Arch Position and BM 5 <i>Arch to Back Layout Finish Action</i> .

BM 5 Arch to Back Layout Finish Action

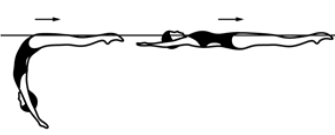
Basic Movement Description	NVT	Diagrams	Major Desired Actions
1. From a Surface Arch Position the hips, chest and face surface sequentially at the same point with foot first movement to a Back Layout Position until the head occupies the position of the hips at the beginning of this action.	7.0		1. See BP 13 Surface Arch Position . Sharp arch in the lower back. The body rises, straightens and moves along the surface of the water with a stationary BP 1 Back Layout Position achieved as the face surfaces. Full extension maintained throughout.

Figure – 117 CATALARC OPEN 180°
DIFFICULTY – 3.0

A *Ballet Leg* is assumed. A *Catalina Rotation* is executed to a **Fishtail Position**. The horizontal leg is lifted in an arc over the surface of the water. As it passes the vertical leg, the vertical leg moves symmetrically in the opposite direction as a 180° rotation is initiated and is completed as a **Split Position** is assumed. A *Walkout Front* is executed.



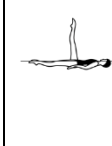
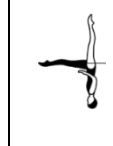
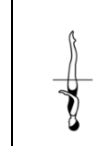
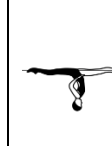
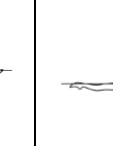

								Total
NVT=	10.5	11.0	24.0	20.5	20.0	23.0	7.0	116
PV =	0.91	0.95	2.07	1.77	1.72	1.98	0.60	10





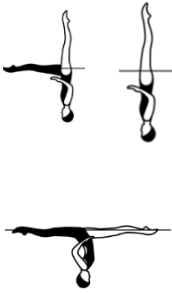
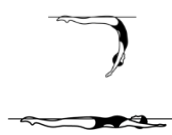
Figure Description	NVT	Diagrams	Major Desired Actions
1. A <i>Ballet Leg</i> is assumed.			1. See Figure 115 Catalina BM 1 <i>To Assume a Ballet Leg.</i>
	10.5		
	11.0		
2. A <i>Catalina Rotation</i> is executed to a Fishtail Position .	24.0		2. See Figure 115 Catalina BM 7 <i>Catalina Rotation.</i>

Figure – 117 CATALARC OPEN 180° (cont.)
DIFFICULTY – 3.0

Figure Description	NVT	Diagrams	Major Desired Actions
<p>3. The horizontal leg is lifted in a 180° arc over the surface of the water. As it passes the vertical, the vertical leg moves symmetrically in the opposite direction as a 180° rotation is initiated and is completed as a Split Position is assumed.</p> <p>It is important to note that the horizontal leg in the Fishtail Position must become the back leg in the Split Position.</p> <p>The diagram shows the Fishtail Position to Split Position movement performed with the left (L) leg shaded black however either leg can be used to perform the action.</p>	<p>20.5</p> <p>20.0</p>		<p>3.1 Height is maintained throughout the lift and pass through of the legs.</p> <p>3.2 The arcing leg moves continuously at a uniform speed with no pause as the legs pass the vertical. The vertical leg moves at the same speed as the arcing leg.</p> <p>3.3 Both legs are always equidistant from the surface of the water and both reach the surface of the water simultaneously during the 180° rotation.</p> <p>3.4 Maximum height and completion of the 180° rotation are achieved simultaneously as BP 16a Surface Split Position is assumed.</p> <p>3.5 The horizontal leg becomes the back leg in the BP 16a Surface Split Position.</p>
<p>4. A <i>Walkout Front</i> is executed.</p>	<p>23.0</p> <p>7.0</p>		<p>4. See Figure 116 Catalarc, BM 6a <i>Walkout Front</i> description and BM 5 <i>Arch to Back Layout Finish Action</i>.</p>

See Figure 115 Catalina for **Back Layout Position, Bent Knee Back Layout Position, Ballet Leg Position, Fishtail Position, To Assume a Ballet Leg Basic Movement and Catalina Rotation Basic Movement**.

See Figure 116 Catalarc for **Split Position, Surface Arch Position, Walkout Front Basic Movement and Arch to Back Layout Finish Action Basic Movement**.

Figure – 118 HELICOPTER
DIFFICULTY – 2.0

A Ballet Leg is assumed. A Catalina Rotation is executed to a Fishtail Position. A Helicopter Rotation Spinning 360° is executed.





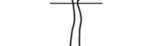












						Total
NVT=	10.5	11.0	24.0	17.5	0	63
PV =	1.67	1.75	3.81	2.78	0	10

Figure Description	NVT	Diagrams	Major Desired Actions
1. A Ballet Leg is assumed.			1. See Figure 115 Catalina BM 1 To Assume a Ballet Leg.
	10.5		
	11.0		
2. A Catalina Rotation is executed to a Fishtail Position.	24.0	 	2. See Figure 115 Catalina BM 7 Catalina Rotation.
3. A Helicopter Rotation Spinning 360° is executed.	17.5	  	3. See BM 17 Helicopter Rotation.
	0	 	

See Figure 115 Catalina for **Back Layout Position, Bent Knee Back Layout Position, Ballet Leg Position, Fishtail Position, To Assume a Ballet Leg Basic Movement and Catalina Rotation Basic Movement.**

Figure – 118 HELICOPTER (cont.)
DIFFICULTY – 2.0
BP 6 Vertical Position - ankle level

Body Position Description	Diagrams	Major Desired Actions
1. Body extended perpendicular to the surface of the water; legs together, head downward. 2. Head (ears specifically), hips and ankles in line.		1. Full extension of the body. 2. Judgement is made by checking visual points of the vertical alignment: ears, shoulder joints, hip joints and ankles.

BM 17 Helicopter Rotation

Basic Movement Description	NVT	Diagrams	Major Desired Actions
1. From a Fishtail Position the horizontal leg is lifted while closing into the vertical leg to assume a Vertical Position during a descending rotation and is completed as the ankles reach the surface of the water.			1.1 See BP 8 Fishtail Position . The legs are joined while descending and rotating to assume a BP 6 Vertical Position at ankle level. 1.2 The vertical leg maintains the vertical line throughout the rotation. 1.3 Longitudinal axis is maintained throughout the rotation. 1.4 Unless otherwise specified, the tempo of the rotation and descent is uniform and at the same speed as the root figure. 1.5 Refer to Section BM 13 <i>Spins</i> and <i>Spin Allowances</i> .

b) Spinning 360°

 b) **Spinning 360°**: A descending Spin with a rotation of 360°.

17.5

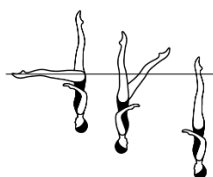

 Refer to BM 17 *Helicopter Rotation* Step 1 Major Desired Actions.

Figure – 118 HELICOPTER (cont.)
DIFFICULTY – 2.0
BM 17 Helicopter Rotation (cont.)

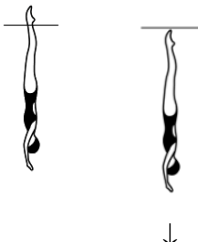
Basic Movement Description	NVT	Diagrams	Major Desired Actions
2. Maintaining a Vertical Position the body descends along its longitudinal axis until the toes are submerged.	0		2. See BP 6 Vertical Position and BM 10 <i>Vertical Descent</i> . The tempo of the descent is uniform and at the same speed as the rest of the figure.

Figure – 125 EIFFEL TOWER
DIFFICULTY – 2.6

A *Ballet Leg* is assumed. Maintaining this position, the body turns sideways towards the horizontal leg, carrying the ballet leg to the surface of the water. The trunk moves downward, turning to *assume a Front Pike Position* as the ballet leg moves across the surface of the water to meet the non-ballet leg. The non-ballet leg is lifted to a **Fishtail Position**. The ballet leg is lifted to a **Vertical Position**. A *Vertical Descent* is executed.






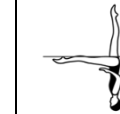
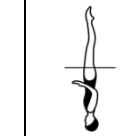
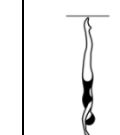
								Total
NVT=	10.5	11.0	18.5	8.0	14.5	20.5	14.0	97
PV =	1.08	1.13	1.91	0.82	1.49	2.11	1.44	10




Figure Description	NVT	Diagrams	Major Desired Actions
1. A <i>Ballet Leg</i> is assumed.			1. See BM 1 To Assume A <i>Ballet Leg</i> .
	10.5		
	11.0		

Figure – 125 EIFFEL TOWER (cont.)
DIFFICULTY – 2.6




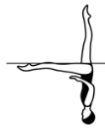



Figure Description	NVT	Diagrams	Major Desired Actions
<p>2. Maintaining this position, the body turns sideways toward the horizontal leg, carrying the ballet leg to the surface of the water.</p>	18.5		<p>2. Body extended on its side with the ear, hip and ankle of the non-ballet leg in alignment. 90° angle maintained between the side ballet leg 'T' position and the horizontal body.</p>
<p>3. The trunk moves downward, turning to <i>assume a Front Pike Position</i> as the ballet leg moves across the surface of the water to meet the non-ballet leg.</p>	8.0	 	<p>3.1 See BM 3 <i>To Assume A Front Pike Position</i>. Downward movement of the body to BP 10 Front Pike Position begins from the 'T' position of the side ballet leg. The body turn, trunk descent, leg join and hip movement along the surface of the water occur simultaneously, with the transition completed as the legs join.</p> <p>3.2 The non-ballet leg remains locked in position with no lateral movement.</p> <p>3.3 The hips replace the head at the surface of the water.</p>
<p>4. The non-ballet leg is lifted to a Fishtail Position.</p> <p>It is important to note that the Ballet Leg becomes the horizontal leg in the Fishtail Position.</p>	14.5		<p>4.1 See BP 8 Fishtail Position. Height and vertical alignment of the trunk is maintained. The Fishtail Position is held only long enough to define the position and to demonstrate completion of the transition.</p> <p>4.2 The foot of the forward leg must be at the surface of the water regardless of the height of the hips.</p> <p>4.3 Hip joints must be on a horizontal line.</p>

Figure – 125 EIFFEL TOWER (cont.)
DIFFICULTY – 2.6

Figure Description	NVT	Diagrams	Major Desired Actions
5. The ballet leg is lifted to a Vertical Position .	20.5		5. See BP Vertical Position . Height is constant as the legs join, with the trunk and the vertical leg maintaining vertical alignment. 5.2 The Vertical Position is held only long enough to define the position and to demonstrate completion of the transition prior to the descent.
6. A <i>Vertical Descent</i> is executed	14.0		6. See BM 10 <i>Vertical Descent</i> .

BP 1 Back Layout Position

Body Position Description	Diagrams	Major Desired Actions
1. Body extended with face, chest, thighs and feet at the surface of the water.		1. Gives the impression that the body is stretched horizontally to its maximum. Front of the trunk will also be at the surface of the water.
2. Head (ears specifically), hips and ankles in horizontal alignment.		2. Judgement is made by checking visual points of the horizontal alignment: ears, shoulder joints, hip joints and ankles. This imaginary line should also pass through the middle of the side of the trunk.

BP 14 Bent Knee Position

Body Position Description	Diagrams	Major Desired Actions
One leg bent with the toe of the bent leg in contact with the inside of the extended leg at the knee or higher.		The relationship of the toe of the bent leg to the extended leg may vary depending on the figure but should remain constant once established, and not extend in front of or behind the extended leg.

b) Bent Knee Back Layout Position

1. Body extended in **Back Layout Position**.




1. In BP 1 **Back Layout Position** ears, shoulder joints, hip joints and ankle of extended leg in line at maximum horizontal alignment.

Figure – 125 EIFFEL TOWER (cont.)
DIFFICULTY – 2.6
BP 14 Bent Knee Position (cont.)

Body Position Description	Diagrams	Major Desired Actions
b) Bent Knee Back Layout Position (cont.) 2. The thigh of the bent leg is perpendicular to the surface of the water.		2. 90° angle between the thigh and the surface of the water, and 90° angle maintained between the thigh and the trunk. At maximum height an air pocket will be evident between the back of the thigh and calf of the bent leg and the surface of the water.

BP 3 Ballet Leg Position

Body Position Description	Diagrams	Major Desired Actions
a) Surface 1. Body in Back Layout Position .		1. See BP 1 Back Layout Position . Ears, shoulder joints, hip joints and ankle of extended leg in line at maximum horizontal alignment.
2. One leg extended perpendicular to the surface of the water.		2. 90° angle between the extended leg and the surface of the water and between the extended leg and the trunk with maximum horizontal alignment maintained throughout.

BP 10 Front Pike Position



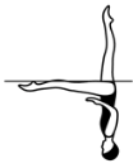

Body Position Description	Diagrams	Major Desired Actions
1. Body bent at hips to form a 90° angle.		1. Exact 90° angle.
2. Legs extended and together.		2. Full extension of legs, with ankles aligned with hip joints.
3. Trunk extended with the back straight and head in line.		3. Back flat, with vertical alignment of ears, shoulder joints and hip joints once the position is established.

Figure – 125 EIFFEL TOWER (cont.)
DIFFICULTY – 2.6
BP 8 Fishtail Position

Body Position Description	Diagrams	Major Desired Actions
1. Body extended in Vertical Position with one leg extended forward. The foot of the forward leg is at the surface of the water regardless of the height of the hips.		1. See BP 6 Vertical Position for body alignment. The foot of the forward leg must be at the surface of the water. Hip joints must be on a horizontal line.

BP 6 Vertical Position

Body Position Description	Diagrams	Major Desired Actions
1. Body extended perpendicular to the surface of the water; legs together, head downward.		1. Full extension of the body.
2. Head (ears specifically), hips and ankles in line.		2. Judgement is made by checking visual points of the vertical alignment: ears, shoulder joints, hip joints and ankles.

BM 1 To Assume a Ballet Leg/A Ballet Leg is assumed





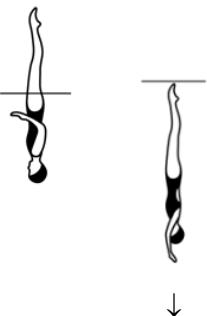
Basic Movement Description	NVT	Diagrams	Major Desired Actions
1. Begin in a Back Layout Position . One leg remains at the surface of the water throughout.			1. See BP 1 Back Layout Position .
2. The foot of the other leg is drawn along the inside of the extended leg to assume a Bent Knee Back Layout Position .	10.5		2. See BP 14b Bent Knee Back Layout Position . The toe of the bending leg remains in contact with the inside of the extended leg. Minimal drop in hips. Position is held only long enough to demonstrate control and accuracy.
3. The bent leg is straightened without movement of the thigh to assume a Ballet Leg Position .	11.0		3.1 See BP 3a Surface Ballet Leg Position . Height remains constant throughout the movement. 3.2 The head and trunk remain stationary throughout.

Figure – 125 EIFFEL TOWER (cont.)
DIFFICULTY – 2.6
BM 3 To Assume a Front Pike Position – adapted

Basic Movement Description	NVT	Diagrams	Major Desired Actions
1. From a side ballet leg ‘T’ position, the trunk moves downward <i>to assume a Front Pike Position</i> as the ballet leg moves across the surface of the water to meet the non-ballet leg. The buttocks, legs and feet travel along the surface of the water until the hips occupy the position of the head at the beginning of this action.	8.0		1.1 See BP 10 Front Pike Position . Uniform motion in downward movement of the trunk. The trunk remains straight throughout the movement. The hips and head lock into position simultaneously.

BM 10 Vertical Descent

Basic Movement Description	NVT	Diagrams	Major Desired Actions
1. Maintaining a Vertical Position the body descends along its longitudinal axis until the toes are submerged.	14.0		1. See BP 6 Vertical Position . The tempo of the descent is uniform and at the same speed as the rest of the figure.

Eiffel Tower 125a – 125g – An Eiffel Tower is executed to a **Vertical Position**. The designated *Twist* or *Spin* is executed.

Note: Refer to Section **BM 12 Twists & Twist Allowances** and Section **BM 13 Spins & Spin Allowances**.

Figure – 125a EIFFEL TOWER 1/2 TWIST
DIFFICULTY – 3.0








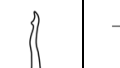
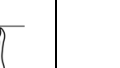
									Total
NVT=	10.5	11.0	18.5	8.0	14.5	20.5	21.0	14.0	118
PV =	0.89	0.93	1.57	0.68	1.23	1.74	1.78	1.19	10

Figure – 125 EIFFEL TOWER (cont.)

Eiffel Tower 125a – 125g – An Eiffel Tower is executed to a **Vertical Position**. The designated *Twist* or *Spin* is executed.

Note: Refer to Section BM 12 Twists & Twist Allowances and Section BM 13 Spins & Spin Allowances.

Figure – 125b EIFFEL TOWER FULL TWIST
DIFFICULTY – 3.2



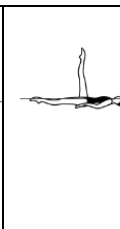
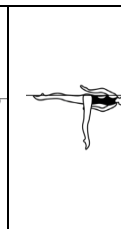
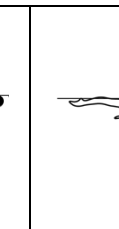
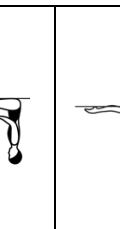
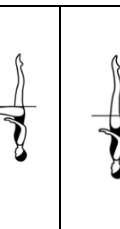
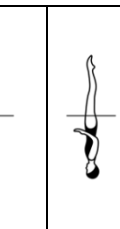
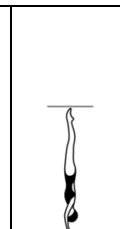
										Total
NVT=	10.5	11.0	18.5	8.0	14.5	20.5	32.0	14.0	129	
PV =	0.81	0.85	1.43	0.62	1.12	1.59	2.48	1.09	10	

Figure – 125c EIFFEL TOWER TWIRL
DIFFICULTY – 3.1



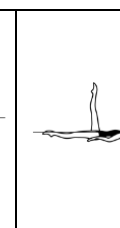
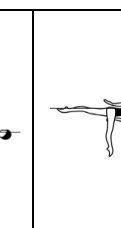
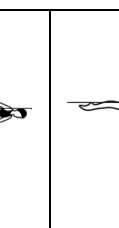
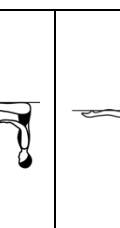
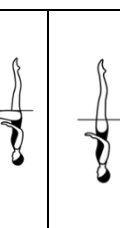
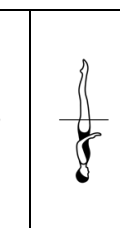
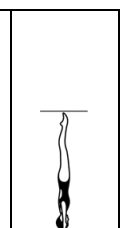
										Total
NVT=	10.5	11.0	18.5	8.0	14.5	20.5	26.0	14.0	123	
PV =	0.85	0.89	1.50	0.65	1.18	1.67	2.11	1.14	10	

Figure – 125d EIFFEL TOWER SPINNING 180°
DIFFICULTY – 2.7



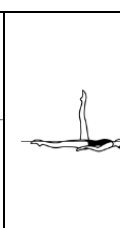
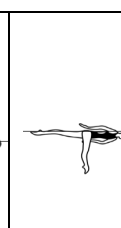
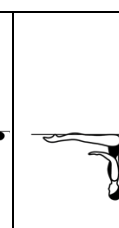
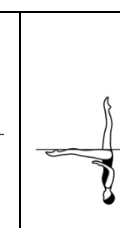
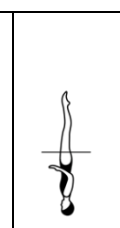
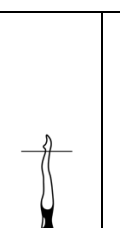
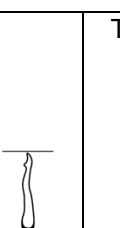
										Total
NVT=	10.5	11.0	18.5	8.0	14.5	20.5	16	0	99	
PV =	1.06	1.11	1.87	0.81	1.46	2.07	1.62	0	10	

Figure – 125 EIFFEL TOWER (cont.)

Eiffel Tower 125a – 125g – An Eiffel Tower is executed to a **Vertical Position**. The designated *Twist* or *Spin* is executed.

Note: Refer to **Section BM 12 Twists & Twist Allowances** and **Section BM 13 Spins & Spin Allowances**.

Figure – 125e EIFFEL TOWER SPINNING 360°
DIFFICULTY – 2.7



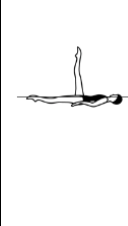

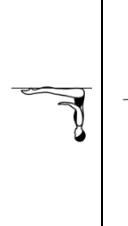
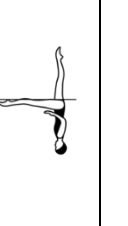
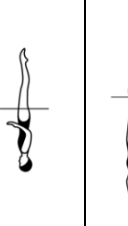
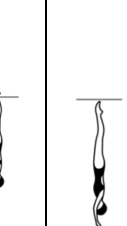
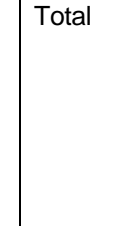
									Total
NVT=	10.5	11.0	18.5	8.0	14.5	20.5	19.0	0	102
PV =	1.03	1.08	1.81	0.78	1.42	2.01	1.86	0	10

Figure – 125f EIFFEL TOWER CONTINUOUS SPIN (720°)
DIFFICULTY – 3.0

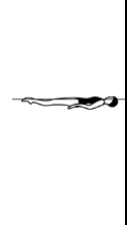

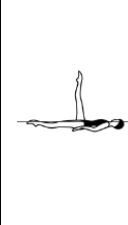
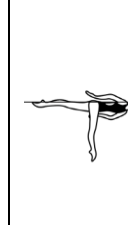
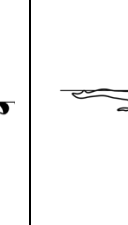
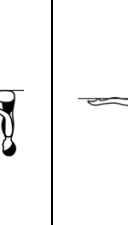
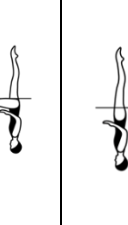
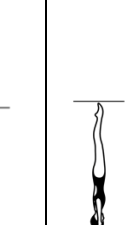
								Total
NVT=	10.5	11.0	18.5	8.0	14.5	20.5	34.0	117
PV =	0.90	0.94	1.58	0.68	1.24	1.75	2.91	10

Figure – 125g EIFFEL TOWER TWIST SPIN
DIFFICULTY – 3.3

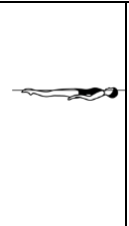
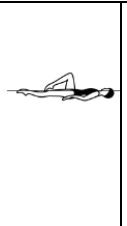

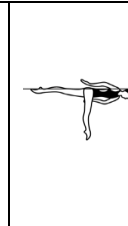
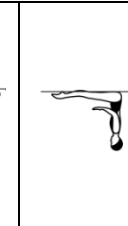
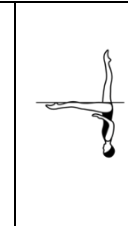
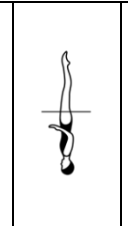
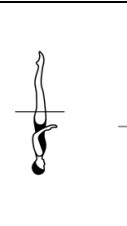
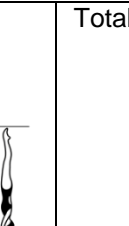
									Total
NVT=	10.5	11.0	18.5	8.0	14.5	20.5	48.0	131	
PV =	0.80	0.84	1.41	0.61	1.11	1.56	3.66	10	

Figure – 125 EIFFEL TOWER (cont.)

Eiffel Tower 125h and 125i – An Eiffel Tower is executed to a **Vertical Position**. A *Vertical Descent* is executed to ankle level. The designated *ascending Spin* is executed.

Note: Refer to Section BM 13 Spins & Spin Allowances.

Figure – 125h EIFFEL TOWER SPIN UP 180°

DIFFICULTY – 3.3






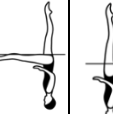
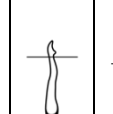
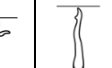
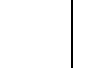

										Total
NVT=	10.5	11.0	18.5	8.0	14.5	20.5	14.0	20.0	14.0	131
PV =	0.80	0.84	1.41	0.61	1.11	1.56	1.07	1.53	1.07	10

Figure – 125i EIFFEL TOWER SPIN UP 360°

DIFFICULTY – 3.3






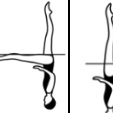
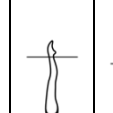
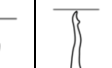


										Total
NVT=	10.5	11.0	18.5	8.0	14.5	20.5	14.0	21.0	14.0	132
PV =	0.80	0.83	1.40	0.61	1.10	1.55	1.06	1.59	1.06	10

Figure – 128 EIFFEL WALK
DIFFICULTY – 2.7

A *Ballet Leg* is assumed. Maintaining this position, the body turns sideways towards the horizontal leg, carrying the ballet leg to the surface of the water. The trunk moves downward, turning to assume a *Front Pike Position* as the ballet leg moves across the surface of the water to meet the non-ballet leg. The non-ballet leg is lifted in a 180° arc over the surface of the water to a **Split Position**. A *Walkout Front* is executed.









								Total
NVT=	10.5	11.0	18.5	8.0	20.0	23.0	7.0	98
PV =	1.07	1.12	1.89	0.82	2.04	2.35	0.71	10

Figure Description	NVT	Diagrams	Major Desired Actions
--------------------	-----	----------	-----------------------

1. A *Ballet Leg* is assumed.



1. See BM 1 To Assume A *Ballet Leg*.

10.5



11.0



2. Maintaining this position, the body turns sideways toward the horizontal leg, carrying the ballet leg to the surface of the water.

18.5



2. Body stretched on its side with the ear, hip and ankle of the non- ballet leg in alignment. 90° angle maintained between the side ballet leg 'T' position and the horizontal body.

Figure – 128 EIFFEL WALK (cont.)
DIFFICULTY – 2.7

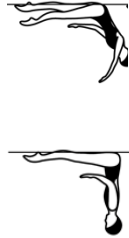





Figure Description	NVT	Diagrams	Major Desired Actions
<p>3. The trunk moves downward, turning to <i>assume a Front Pike Position</i> as the ballet leg moves across the surface of the water to meet the non-ballet leg.</p>	8.0		<p>3.1 See BM 3 <i>To Assume A Front Pike Position-adapted</i>. Downward movement of the body to BP 10 Front Pike Position begins from the 'T' position of the side ballet leg. The body turn, trunk descent, leg join and hip movement along the surface of the water occur simultaneously, with the transition completed as the legs join.</p> <p>3.2 The non-ballet leg remains locked in position with no lateral movement.</p> <p>3.3 The hips replace the head at the surface of the water.</p>
<p>4. The non-ballet leg is lifted in a 180° arc over the surface of the water to assume a Split Position.</p> <p>It is important to note that the Ballet Leg becomes the front leg in the Surface Split Position.</p>	20.0		<p>4. See BP 16a Surface Split Position. Trunk position, height and tempo remain constant through arcing action.</p>
<p>5. A <i>Walkout Front</i> is executed.</p>	23.0		<p>5. See BM 6a <i>Walkout Front</i> and see BM 5 <i>Arch to Back Layout Position</i>.</p>
	7.0		

Figure – 128 EIFFEL WALK (cont.)
DIFFICULTY – 2.7
BP 1 Back Layout Position

Body Position Description	Diagrams	Major Desired Actions
1. Body extended with face, chest, thighs and feet at the surface of the water.		1. Gives the impression that the body is stretched horizontally to its maximum. Front of the trunk will also be at the surface of the water.
2. Head (ears specifically), hips and ankles in horizontal alignment.		2. Judgement is made by checking visual points of the horizontal alignment: ears, shoulder joints, hip joints and ankles. This imaginary line should also pass through the middle of the side of the trunk.

BP 14 Bent Knee Position

Body Position Description	Diagrams	Major Desired Actions
One leg bent with the toe of the bent leg in contact with the inside of the extended leg at the knee or higher.		The relationship of the toe of the bent leg to the extended leg may vary depending on the figure but should remain constant once established, and not extend in front of or behind the extended leg.

b) Bent Knee Back Layout Position

1. Body extended in **Back Layout Position**.




2. The thigh of the bent leg is perpendicular to the surface of the water.

1. In BP 1 **Back Layout Position** ears, shoulder joints, hip joints and ankle of extended leg in line at maximum horizontal alignment.

2. 90° angle between the thigh and the surface of the water, and 90° angle maintained between the thigh and the trunk. At maximum height an air pocket will be evident between the back of the thigh and calf of the bent leg and the surface of the water.

Figure – 128 EIFFEL WALK (cont.)
DIFFICULTY – 2.7
BP 3 Ballet Leg Position

Body Position Description	Diagrams	Major Desired Actions
<p>a) Surface</p> <p>1. Body in Back Layout Position.</p> <p>2. One leg extended perpendicular to the surface of the water.</p>		<p>1. See BP 1 Back Layout Position. Ears, shoulder joints, hip joints and ankle of extended leg in line at maximum horizontal alignment.</p> <p>2. 90° angle between the extended leg and the surface of the water and between the extended leg and the trunk with maximum horizontal alignment maintained throughout.</p>

BP 10 Front Pike Position






Body Position Description	Diagrams	Major Desired Actions
<p>1. Body bent at hips to form a 90° angle.</p>		<p>1. Exact 90° angle.</p>
<p>2. Legs extended and together.</p>		<p>2. Full extension of legs, with ankles aligned with hip joints.</p>
<p>3. Trunk extended with the back straight and head in line.</p>		<p>3. Back flat, with vertical alignment of ears, shoulder joints and hip joints once the position is established.</p>

Figure – 128 EIFFEL WALK (cont.)
DIFFICULTY – 2.7
BP 16 Split Position

Body Position Description	Diagrams	Major Desired Actions
<ol style="list-style-type: none"> 1. Legs evenly split forward and back. 2. The legs are parallel to the surface of the water. 3. Lower back arched, with hips, shoulders and head on a vertical line. 4. 180° angle between the extended legs (flat split), with inside of each leg aligned on opposite sides of a horizontal line, regardless of the height of the hips. 		<ol style="list-style-type: none"> 1. Full extension of the legs at or above the surface of the water. 4. Flat split. Hip joints and shoulder joints on a horizontal line, with both of these alignments 'square' and parallel to each other.
<p>a) Surface Split Position</p> <ol style="list-style-type: none"> 1. Legs are dry at the surface of the water. 		<ol style="list-style-type: none"> 1. Full extension of the legs. Crotch and legs dry at the surface of the water.

BP 13 Surface Arch Position

Body Position Description	Diagrams	Major Desired Actions
<ol style="list-style-type: none"> 1. Lower back arched with hips, shoulders and head on a vertical line. 2. Legs together and at the surface of the water. 		<ol style="list-style-type: none"> 1. Hip joints and shoulder joints on a horizontal line with both of these alignments 'square' and parallel to one another. Head (ears specifically) in line with shoulders. 2. Hips joints at the surface of the water.

BM 1 To Assume a Ballet Leg/A Ballet Leg is assumed





Basic Movement Description	NVT	Diagrams	Major Desired Actions
<ol style="list-style-type: none"> 1. Begin in a Back Layout Position. One leg remains at the surface of the water throughout. 2. The foot of the other leg is drawn along the inside of the extended leg to assume a Bent Knee Back Layout Position. 	10.5	 	<ol style="list-style-type: none"> 1. See BP 1 Back Layout Position. 2. See BP 14b Bent Knee Back Layout Position. The toe of the bending leg remains in contact with the inside of the extended leg. Minimal drop in hips. Position is held only long enough to demonstrate control and accuracy.

Figure – 128 EIFFEL WALK (cont.)
DIFFICULTY – 2.7
BM 1 To Assume a Ballet Leg/A Ballet Leg is assumed (cont.)

Basic Movement Description	NVT	Diagrams	Major Desired Actions
3. The bent leg is straightened without movement of the thigh to assume a Ballet Leg Position .	11.0		3.1 See BP 3a Surface Ballet Leg Position . Height remains constant throughout the movement. 3.2 The head and trunk remain stationary throughout.

BM 3 To Assume a Front Pike Position – adapted

Basic Movement Description	NVT	Diagrams	Major Desired Actions
1. From a side ballet leg 'T' position, the trunk moves downward <i>to assume a Front Pike Position</i> , as the ballet leg moves across the surface of the water to meet the non-ballet leg. The buttocks, legs and feet travel along the surface of the water until the hips occupy the position of the head at the beginning of this action.	8.0		1.1 See BP 10 Front Pike Position . Uniform motion in downward movement of the trunk. The trunk remains straight throughout the movement. The hips and head lock into position simultaneously.

BM 6 Walkouts


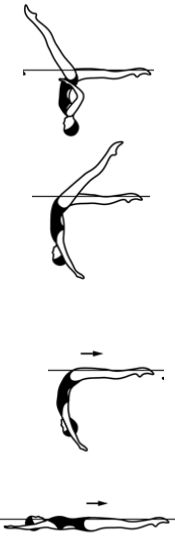
Basic Movement Description	NVT	Diagrams	Major Desired Actions
1. These movements start in a Split Position unless otherwise specified in the figure description. The hips remain stationary as one leg is lifted in an arc over the surface of the water to meet the opposite leg.			1. See BP 16a Surface Split Position .

Figure – 128 EIFFEL WALK (cont.)
DIFFICULTY – 2.7
BM 6 Walkouts (cont.)

Basic Movement Description	NVT	Diagrams	Major Desired Actions
<p>a) Walkout Front</p> <p>2. The front leg is lifted in a 180° arc over the surface of the water to meet the opposite leg in a Surface Arch Position and with continuous movement an <i>Arch to Back Layout Finish Action</i> is executed.</p>	<p>23.0</p> <p>7.0</p>		<p>2.1 Hip height remains constant and at the surface of the water.</p> <p>2.2 Arcing leg moves continuously with uniform motion.</p> <p>2.3 Both legs maintain full extension.</p> <p>2.4 The trunk remains stationary until the feet join.</p> <p>2.5 No pause in BP 13 Surface Arch Position, however an accurate surface arch must be evident before the body begins to rise and straighten.</p> <p>2.6 Foot first surfacing motion begins when the feet are joined.</p> <p>2.7 See BP 13 Surface Arch Position and BM 5 <i>Arch to Back Layout Finish Action</i>.</p>

BM 5 Arch to Back Layout Finish Action


Basic Movement Description	NVT	Diagrams	Major Desired Actions
<p>1. From a Surface Arch Position the hips, chest and face surface sequentially at the same point with foot first movement to a Back Layout Position until the head occupies the position of the hips at the beginning of this action.</p>	<p>7.0</p>		<p>1. See BP 13 Surface Arch Position. Sharp arch in the lower back. The body rises, straightens and moves along the surface of the water with a stationary BP 1 Back Layout Position achieved as the face surfaces. Full extension maintained throughout.</p>

Figure – 130 FLAMINGO
DIFFICULTY – 2.4

A *Ballet Leg* is assumed. The shin of the horizontal leg is drawn along the surface of the water to assume a **Surface Flamingo Position**. The bent leg is straightened to a **Surface Ballet Leg Double Position**. Maintaining the vertical position of the legs, the hips are lifted as the trunk is unrolled to **Vertical Position**. A *Vertical Descent* is executed.






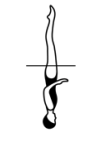
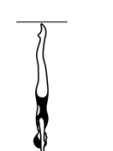
							Total
NVT=	10.5	11.0	7.5	13.0	28.0	14.0	84
PV =	1.25	1.31	0.89	1.55	3.33	1.67	10






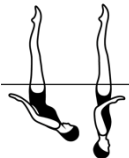


Figure Description	NVT	Diagrams	Major Desired Actions
1. A <i>Ballet Leg</i> is assumed.			1. See <i>BM 1 To Assume A Ballet Leg</i> .
	10.5		
	11.0		
2. The shin of the horizontal leg is drawn along the surface of the water to assume a Surface Flamingo Position .	7.5		2. See BP 4a Surface Flamingo Position . Height and vertical alignment of the ballet leg remains constant.
3. The bent leg is straightened to a Surface Ballet Leg Double Position .	13.0		3. See BP 5a Surface Ballet Leg Double Position . No change in height on lift. This position is held only long enough to define the position and to demonstrate completion of the transition.

Figure – 130 FLAMINGO (cont.)
DIFFICULTY – 2.4

Figure Description	NVT	Diagrams	Major Desired Actions
4. Maintaining the vertical position of the legs, the hips are lifted as the trunk is unrolled to a Vertical Position .	28.0		<p>4.1 BP 6 Vertical Position assumed under and in the same plane as the Surface Double Ballet Leg Position.</p> <p>4.2 The lift of hips and the unrolling to Vertical Position is completed as maximum height is achieved.</p> <p>4.3 The Vertical Position is held only long enough to define the position and to demonstrate completion of the transition.</p>
5. A <i>Vertical Descent</i> is executed.	14.0		5. See BM 10 <i>Vertical Descent</i> .


BP 1 Back Layout Position

Body Position Description	Diagrams	Major Desired Actions
1. Body extended with face, chest, thighs and feet at the surface of the water.		1. Gives the impression that the body is stretched horizontally to its maximum. Front of the trunk will also be at the surface of the water.
2. Head (ears specifically), hips and ankles in horizontal alignment.		2. Judgement is made by checking visual points of the horizontal alignment: ears, shoulder joints, hip joints and ankles. This imaginary line should also pass through the middle of the side of the trunk.


BP 14 Bent Knee Position

Body Position Description	Diagrams	Major Desired Actions
One leg bent with the toe of the bent leg in contact with the inside of the extended leg at the knee or higher.		The relationship of the toe of the bent leg to the extended leg may vary depending on the figure but should remain constant once established, and not extend in front of or behind the extended leg.

Figure – 130 FLAMINGO (cont.)
DIFFICULTY – 2.4
BP 14 Bent Knee Position (cont.)

Body Position Description	Diagrams	Major Desired Actions
b) Bent Knee Back Layout Position 1. Body extended in Back Layout Position . 2. The thigh of the bent leg is perpendicular to the surface of the water.		1. In BP 1 Back Layout Position ears, shoulder joints, hip joints and ankle of extended leg in line at maximum horizontal alignment. 2. 90° angle between the thigh and the surface of the water, and 90° angle maintained between the thigh and the trunk. At maximum height an air pocket will be evident between the back of the thigh and calf of the bent leg and the surface of the water.

BP 3 Ballet Leg Position

Body Position Description	Diagrams	Major Desired Actions
a) Surface 1. Body in Back Layout Position . 2. One leg extended perpendicular to the surface of the water.		1. See BP 1 Back Layout Position . Ears, shoulder joints, hip joints and ankle of extended leg in line at maximum horizontal alignment. 2. 90° angle between the extended leg and the surface of the water and between the extended leg and the trunk with maximum horizontal alignment maintained throughout.

BP 4 Flamingo Position




Body Position Description	Diagrams	Major Desired Actions
a) Surface 1. One leg extended perpendicular to the surface of the water. 2. The other leg bent with the mid-calf opposite the vertical leg. Foot, shin and knee at and parallel to the surface of the water.		1. 90° angle between the extended leg and the surface of the water. 2. The top of the bent leg from knee to toes should be dry with the vertical leg extended perpendicular midway between the knee and ankle of the horizontal leg.

Figure – 130 FLAMINGO (cont.)
DIFFICULTY – 2.4
BP 4 Flamingo Position (cont.)

Body Position Description	Diagrams	Major Desired Actions
a) Surface (cont.) 3. Face at the surface of the water.		3. Chest close to the surface of the water with the shoulders back. Ears, shoulder joints and hip joints aligned with the spine straight and extended.

BP 5 Ballet Leg Double Position

Body Position Description	Diagrams	Major Desired Actions
a) Surface 1. Legs together and extended perpendicular to the surface of the water.		1. Full extension of the legs at a 90° angle to the surface of the water.
2. Head in line with the trunk.		2. Chest close to the surface of the water with the shoulders back. Ears, hip joints and shoulder joints aligned, with the spine straight and extended.
3. Face at the surface of the water.		

BP 6 Vertical Position





Body Position Description	Diagrams	Major Desired Actions
1. Body extended perpendicular to the surface of the water; legs together, head downward.		1. Full extension of the body.
2. Head (ears specifically), hips and ankles in line.		2. Judgement is made by checking visual points of the vertical alignment: ears, shoulder joints, hip joints and ankles.

Figure – 130 FLAMINGO (cont.)
DIFFICULTY – 2.4
BM 1 To Assume a Ballet Leg/A Ballet Leg is assumed

Basic Movement Description	NVT	Diagrams	Major Desired Actions
1. Begin in a Back Layout Position . One leg remains at the surface of the water throughout.			1. See BP 1 Back Layout Position .
2. The foot of the other leg is drawn along the inside of the extended leg to assume a Bent Knee Back Layout Position .	10.5		2. See BP 14b Bent Knee Back Layout Position . The toe of the bending leg remains in contact with the inside of the extended leg. Minimal drop in hips. Position is held only long enough to demonstrate control and accuracy.
3. The bent leg is straightened without movement of the thigh to assume a Ballet Leg Position .	11.0		3.1 See BP 3a Surface Ballet Leg Position . Height remains constant throughout the movement. 3.2 The head and trunk remain stationary throughout.

BM 10 Vertical Descent

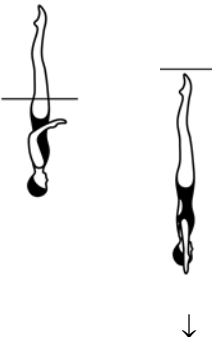
Basic Movement Description	NVT	Diagrams	Major Desired Actions
1. Maintaining a Vertical Position the body descends along its longitudinal axis until the toes are submerged.	14.0		1. See BP 6 Vertical Position . The tempo of the descent is uniform and at the same speed as the rest of the figure.

Figure – 130 FLAMINGO (cont.)

Flamingo 130a – 130g, 130j – A Flamingo is executed to **Vertical Position**. The designated *Twist or Spin* is executed.

Note: Refer to Section BM 12 Twists & Twist Allowances and Section BM 13 Spins & Spin Allowances.

Figure – 130a FLAMINGO ½ TWIST
DIFFICULTY – 2.8




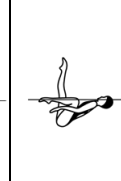
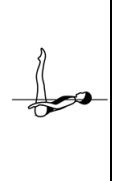
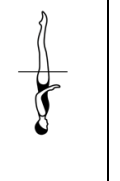
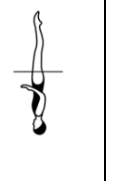
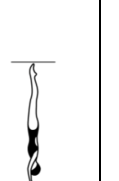
								Total
NVT=	10.5	11.0	7.5	13.0	28.0	21.0	14.0	105
PV =	1.00	1.05	0.71	1.24	2.67	2.00	1.33	10

Figure – 130b FLAMINGO FULL TWIST
DIFFICULTY – 3.0


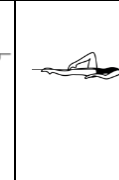
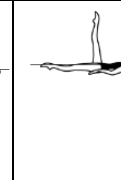
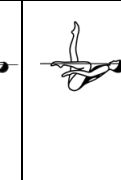
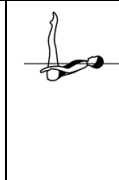
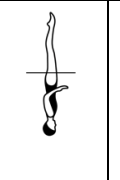
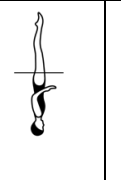
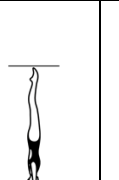
								Total
NVT=	10.5	11.0	7.5	13.0	28.0	32.0	14.0	116
PV =	0.91	0.95	0.65	1.12	2.41	2.76	1.21	10

Figure – 130c FLAMINGO TWIRL
DIFFICULTY – 2.9


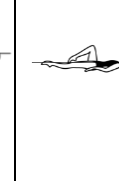
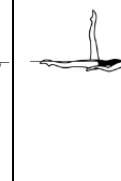
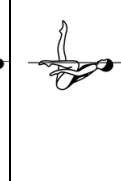
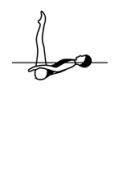
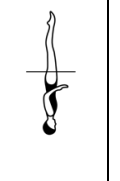
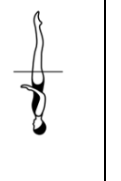
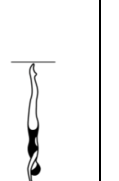
								Total
NVT=	10.5	11.0	7.5	13.0	28.0	26.0	14.0	110
PV =	0.95	1.00	0.68	1.18	2.55	2.36	1.27	10

Figure – 130d FLAMINGO SPINNING 180°
DIFFICULTY – 2.4



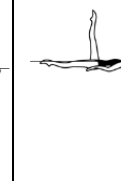
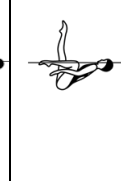
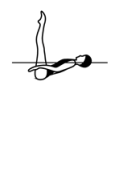
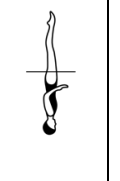
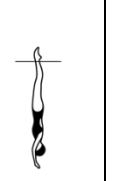
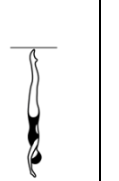
								Total
NVT=	10.5	11.0	7.5	13.0	28.0	16.0	0	86.0
PV =	1.22	1.28	0.87	1.51	3.26	1.86	0	10

Figure – 130 FLAMINGO (cont.)

Flamingo 130a – 130g, 130j – A Flamingo is executed to **Vertical Position**. The designated *Twist or Spin* is executed.

Note: Refer to Section **BM 12 Twists & Twist Allowances** and Section **BM 13 Spins & Spin Allowances**.

Figure – 130e FLAMINGO SPINNING 360°

DIFFICULTY – 2.5






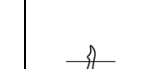

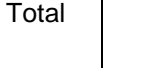
								Total
NVT=	10.5	11.0	7.5	13.0	28.0	19.0	0	89.0
PV =	1.18	1.24	0.84	1.46	3.15	2.13	0	10

Figure – 130f FLAMINGO CONTINUOUS SPIN (720°)

DIFFICULTY – 2.8





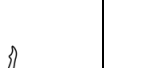
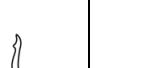
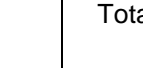
							Total
NVT=	10.5	11.0	7.5	13.0	28.0	34.0	104.0
PV =	1.01	1.06	0.72	1.25	2.69	3.27	10

Figure – 130g FLAMINGO TWIST SPIN

DIFFICULTY – 3.0





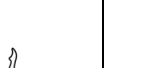
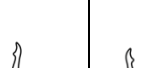

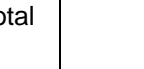
								Total
NVT=	10.5	11.0	7.5	13.0	28.0	48.0	118	
PV =	0.89	0.93	0.64	1.10	2.37	4.07	10	

Figure – 130 FLAMINGO (cont.)

Flamingo 130h and 130i – A Flamingo is executed to **Vertical Position**. A *Vertical Descent* is executed to ankle level. The designated *ascending Spin* is executed.

Note: Refer to Section BM 13 Spins & Spin Allowances.

Figure – 130h FLAMINGO SPIN UP 180°
DIFFICULTY – 3.0

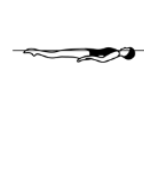
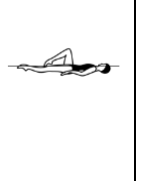
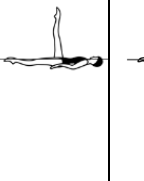
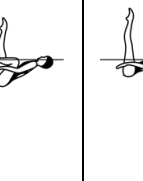
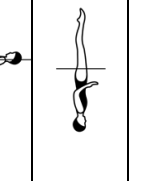
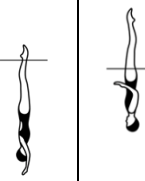
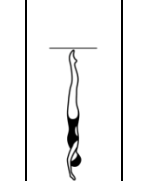


									Total
NVT=	10.5	11.0	7.5	13.0	28.0	14.0	20.0	14.0	118
PV =	0.89	0.93	0.64	1.10	2.37	1.19	1.69	1.19	10

Figure – 130i FLAMINGO SPIN UP 360°
DIFFICULTY – 3.0


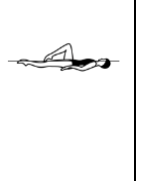
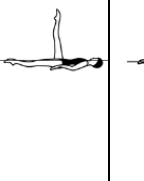
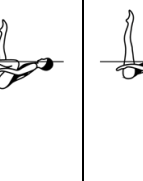
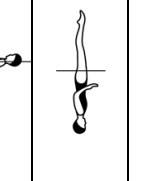
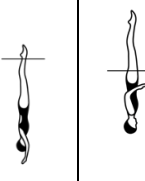
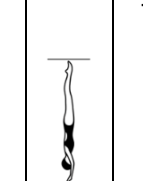



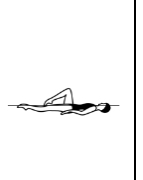
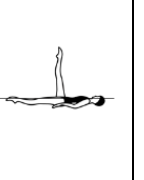
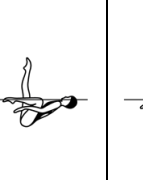
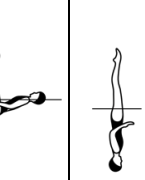
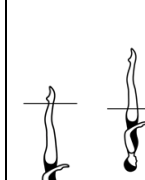
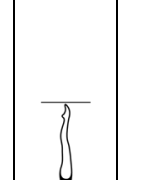


									Total
NVT=	10.5	11.0	7.5	13.0	28.0	14.0	21.0	14.0	119
PV =	0.88	0.92	0.63	1.09	2.35	1.18	1.76	1.18	10

Figure – 130j FLAMINGO COMBINED SPIN (360° + 360°)*
DIFFICULTY – 3.1

									Total
NVT=	10.5	11.0	7.5	13.0	28.0	40.0	14.0	124.0	
PV =	0.85	0.89	0.60	1.05	2.26	3.23	1.13	10	

***Note: Refer to Section BM 13 Spins. There is no Spin Allowance for Combined Spins.**

Figure – 140 FLAMINGO BENT KNEE
DIFFICULTY – 2.3

A *Ballet Leg* is assumed. The shin of the horizontal leg is drawn along the surface of the water to assume a **Surface Flamingo Position**. With the ballet leg maintaining its vertical position the hips are lifted as the trunk unrolls while the bent leg moves to a **Bent Knee Vertical Position**. The bent leg is extended to **Vertical Position**. A *Vertical Descent* is executed.





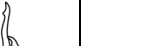
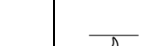

							Total
NVT=	10.5	11.0	7.5	20.0	16.5	14.0	79.5
PV =	1.32	1.38	0.94	2.52	2.08	1.76	10





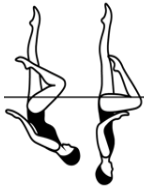


Figure Description	NVT	Diagrams	Major Desired Actions
1. A <i>Ballet Leg</i> is assumed.			1. See BM 1 To Assume A <i>Ballet Leg</i> .
	10.5		
	11.0		1. See BM 1 To Assume A <i>Ballet Leg</i> .
2. The shin of the horizontal leg is drawn along the surface of the water to assume a Surface Flamingo Position .	7.5		2. See BP 4a Surface Flamingo Position . Height of the ballet leg remains constant.
3. With the ballet leg maintaining its vertical position, the hips are lifted as the trunk unrolls while the bent leg moves to a Bent Knee Vertical Position .	20.0		3.1 See BP 14c Bent Knee Vertical Position . The bent leg moves simultaneously to the Bent Knee Vertical Position as the hips are lifted and the trunk unrolls. 3.2 The vertical leg remains perpendicular to the surface of the water. 3.3 All actions are simultaneously completed as maximum height is achieved. 3.4 The Bent Knee Vertical Position is assumed under, and in the same plane as the ballet leg of the BP 4a Surface Flamingo Position .

Figure – 140 FLAMINGO BENT KNEE (cont.)
DIFFICULTY – 2.3

Figure Description	NVT	Diagrams	Major Desired Actions
4. The bent leg is extended to Vertical Position .	16.5		<p>4.1 BP 6 Vertical Position assumed under and in the same plane as the Bent Knee Vertical Position. The height of the Bent Knee Vertical Position is maintained as the bent leg is extended to Vertical Position.</p> <p>4.2 Vertical alignment is maintained during the leg join.</p> <p>4.3 The Vertical Position is held only long enough to define the position and to demonstrate completion of the transition prior to the <i>Vertical Descent</i>.</p>
5. A <i>Vertical Descent</i> is executed.	14.0		5. See BM 10 <i>Vertical Descent</i> .

See Figure 130 Flamingo for **Back Layout Position, Bent Knee Back Layout Position, Ballet Leg Single Position, Flamingo Position, Vertical Position, To Assume A Ballet Leg Basic Movement and Vertical Descent Basic Movement.**

BP 14 Bent Knee Position


Body Position Description	Diagrams	Major Desired Actions
One leg bent with the toe of the bent leg in contact with the inside of the extended leg at the knee or higher.		The relationship of the toe of the bent leg to the extended leg may vary depending on the figure but should remain constant once established, and not extend in front of or behind the extended leg.
<p>c) Bent Knee Vertical Position</p> <p>1. Body extended in Vertical Position with the thigh of the bent leg parallel to the surface of the water.</p>		1. In BP 6 Vertical Position the alignment of the extended leg, trunk and head remains constant.

Figure – 140 FLAMINGO BENT KNEE (cont.)
DIFFICULTY – 2.3

Flamingo Bent Knee 140a – 140g, 140j – A Flamingo Bent Knee is executed to **Vertical Position**. The designated *Twist or Spin* is executed.

Note: Refer to Section BM 12 Twists & Twist Allowances and Section BM 13 Spins and Spin Allowances.

Figure – 140a FLAMINGO BENT KNEE ½ TWIST
DIFFICULTY – 2.7


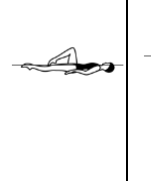
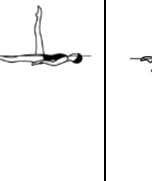
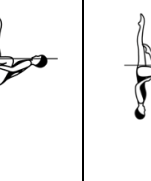
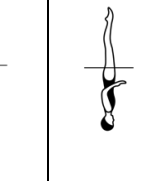
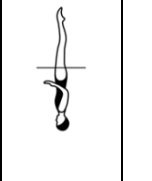
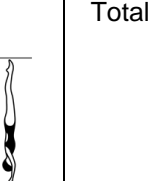

								Total
NVT=	10.5	11.0	7.5	20.0	16.5	21.0	14.0	100.5
PV =	1.04	1.09	0.75	1.99	1.64	2.09	1.39	10

Figure – 140b FLAMINGO BENT KNEE FULL TWIST
DIFFICULTY – 2.9


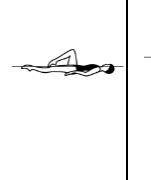
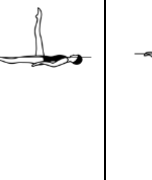
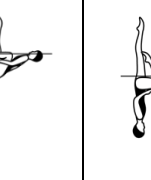
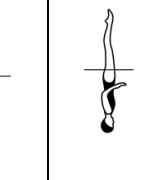
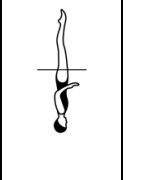
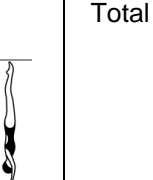

								Total
NVT=	10.5	11.0	7.5	20.0	16.5	32.0	14.0	111.5
PV =	0.94	0.99	0.67	1.79	1.48	2.87	1.26	10

Figure – 140c FLAMINGO BENT KNEE TWIRL
DIFFICULTY – 2.8


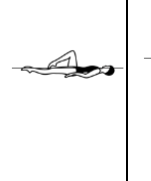
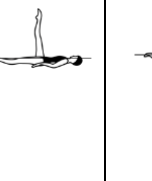
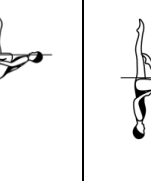
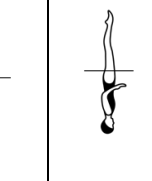
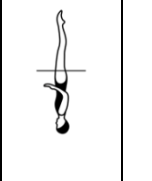
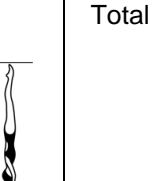

								Total
NVT=	10.5	11.0	7.5	20.0	16.5	26.0	14.0	105.5
PV =	1.00	1.04	0.71	1.90	1.56	2.46	1.33	10

Figure – 140d FLAMINGO BENT KNEE SPINNING 180°
DIFFICULTY – 2.4


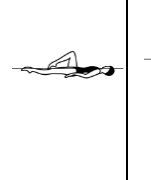
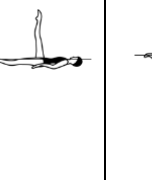
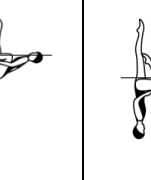
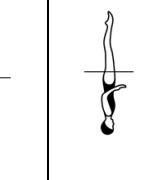
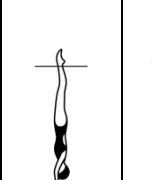
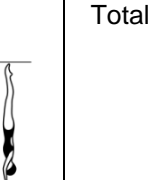

								Total
NVT=	10.5	11.0	7.5	20.0	16.5	16.0	0	81.5
PV =	1.29	1.35	0.92	2.45	2.02	1.96	0	10

Figure – 140 FLAMINGO BENT KNEE (cont.)
DIFFICULTY – 2.3

Flamingo Bent Knee 140a – 140g, 140j – A Flamingo Bent Knee is executed to **Vertical Position**. The designated *Twist or Spin* is executed.

Note: Refer to Section BM 12 Twists & Twist Allowances and Section BM 13 Spins and Spin Allowances.

Figure – 140e FLAMINGO BENT KNEE SPINNING 360°
DIFFICULTY – 2.4






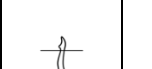
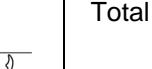

								Total
NVT=	10.5	11.0	7.5	20.0	16.5	19.0	0	84.5
PV =	1.24	1.30	0.89	2.37	1.95	2.25	0	10

Figure – 140f FLAMINGO BENT KNEE CONTINUOUS SPIN (720°) DIFFICULTY – 2.7




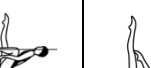

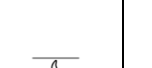
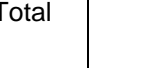
							Total
NVT=	10.5	11.0	7.5	20.0	16.5	34.0	99.5
PV=	1.06	1.11	0.75	2.01	1.66	3.42	10

Figure – 140g FLAMINGO BENT KNEE TWIST SPIN
DIFFICULTY – 2.9






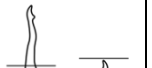
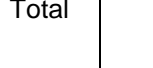







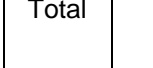

								Total
NVT=	10.5	11.0	7.5	20.0	16.5	48.0	113.5	
PV =	0.93	0.97	0.66	1.76	1.45	4.23	10	

Figure – 140j FLAMINGO BENT KNEE COMBINED SPIN (360° + 360°)* DIFFICULTY – 3.1

								Total
NVT=	10.5	11.0	7.5	20.0	16.5	40.0	14.0	119.5
PV =	0.88	0.92	0.63	1.67	1.38	3.35	1.17	10

***Note:** Refer to Section BM 13 Spins. There is no Spin Allowance for Combined Spins.

Figure – 140 FLAMINGO BENT KNEE (cont.)
DIFFICULTY – 2.3

Flamingo Bent Knee 140h and 140i – A Flamingo Bent Knee is executed to **Vertical Position**. A *Vertical Descent* is executed to ankle level. The designated *ascending Spin* is executed.

Note: Refer to Section BM 13 Spins & Spin Allowances.

Figure – 140h FLAMINGO BENT KNEE SPIN UP 180°
DIFFICULTY – 2.9

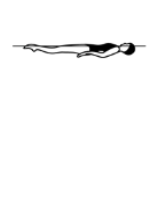
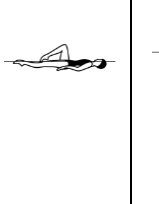
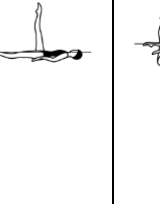
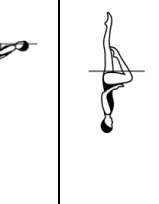
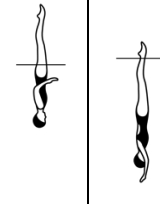
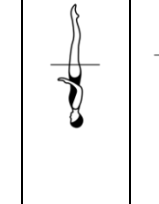


									Total
NVT=	10.5	11.0	7.5	20.0	16.5	14.0	20.0	14.0	113.5
PV =	0.93	0.97	0.66	1.76	1.45	1.23	1.76	1.23	10

Figure – 140i FLAMINGO BENT KNEE SPIN UP 360°
DIFFICULTY – 3.0

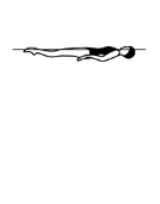
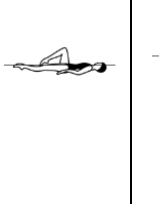
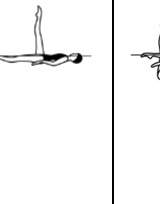
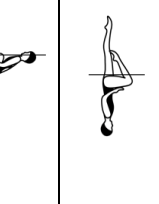
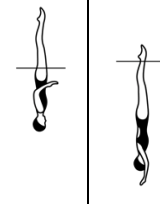
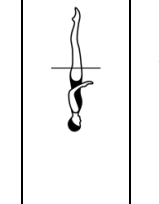


									Total
NVT=	10.5	11.0	7.5	20.0	16.5	14.0	21.0	14.0	114.5
PV =	0.92	0.96	0.66	1.75	1.44	1.22	1.83	1.22	10

Figure – 141 STINGRAY
DIFFICULTY – 3.1

A *Ballet Leg* is assumed. The shin of the horizontal leg is drawn along the surface of the water to assume a **Surface Flamingo Position**. With the ballet leg maintaining its vertical position, the hips are lifted as the trunk unrolls while the bent leg straightens with the knee at the surface of the water to assume a **Fishtail Position**. The horizontal leg is lifted in an arc over the surface of the water. As it passes the vertical leg, the vertical leg moves symmetrically in the opposite direction as a 180° rotation is initiated and is completed as a **Split Position** is assumed. A *Walkout Front* is executed.


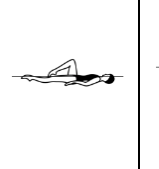
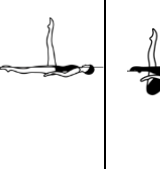
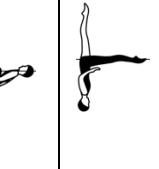
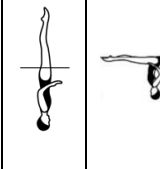
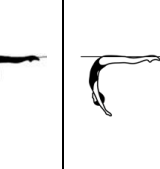
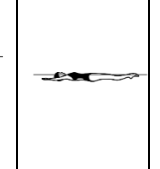


									Total
NVT=	10.5	11.0	7.5	22.5	20.5	20.0	23.0	7.0	122
PV=	0.86	0.90	0.61	1.84	1.68	1.64	1.89	0.57	10

Figure Description	NVT	Diagrams	Major Desired Actions
--------------------	-----	----------	-----------------------

1. A *Ballet Leg* is assumed.



1. See BM 1 To Assume A Ballet Leg.

10.5



11.0



1. See BM 1 To Assume A Ballet Leg.

Figure – 141 STINGRAY (cont.)
DIFFICULTY – 3.1



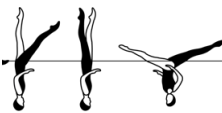




Figure Description	NVT	Diagrams	Major Desired Actions
<p>2. The shin of the horizontal leg is drawn along the surface of the water to assume a Surface Flamingo Position.</p>	7.5		<p>2. See BP 4a Surface Flamingo Position. Height of the ballet leg remains constant.</p>
<p>3. With the ballet maintaining its vertical position, the hips are lifted as the trunk unrolls while the bent leg straightens with the knee at the surface of the water to assume a Fishtail Position.</p> <p>It is important to note that the horizontal leg in the Flamingo Position becomes the horizontal leg in the Fishtail Position.</p> <p>The diagram shows the movement performed with the left (L) leg shaded black however either leg can be used to perform the action.</p>	22.5		<p>3.1 See BP 8 Fishtail Position. The bent leg moves simultaneously to the Fishtail Position as the hips are lifted and the trunk unrolls.</p> <p>3.2 All actions are completed simultaneously as maximum height is achieved.</p> <p>3.3 BP 8 Fishtail Position is assumed under and in the same plane as the ballet leg of the BP 4a Surface Flamingo Position.</p>
<p>4. The horizontal leg is lifted in an arc over the surface of the water. As it passes the vertical leg, the vertical leg moves symmetrically in the opposite direction as a 180° rotation is initiated and is completed as a Split Position is assumed.</p> <p>It is important to note that the horizontal leg in the Fishtail Position must become the back leg in the Split Position.</p> <p>The diagram shows the Fishtail Position to Split Position movement performed with the left (L) leg shaded black however either leg can be used to perform the action.</p>	20.5		<p>4.1 Water level established in BP 8 Fishtail Position is maintained as the horizontal leg is lifted to vertical.</p> <p>No pause as the legs pass through the vertical position prior to the lowering action of the legs.</p> <p>4.2 From the vertical position to BP 16a Surface Split Position both legs are always equidistant from the water and reach the surface of the water simultaneously. Tempo of the leg raise to vertical is the same as the lowering to Split Position.</p> <p>4.3 Maximum height and completion of the 180° rotation are achieved simultaneously as BP 16a Surface Split Position is assumed. The lifted leg becomes the back leg in the BP 16a Surface Split Position.</p>
	20.0		

Figure – 141 STINGRAY (cont.)
DIFFICULTY – 3.1

Figure Description	NVT	Diagrams	Major Desired Actions
5. A <i>Walkout Front</i> is executed.	23.0		5. See BM 6a <i>Walkout Front</i> and see BM 5 <i>Arch to Back Layout Position</i> .
	7.0		

BP 1 Back Layout Position

Body Position Description	Diagrams	Major Desired Actions
1. Body extended with face, chest, thighs and feet at the surface of the water.		1. Gives the impression that the body is stretched horizontally to its maximum. Front of the trunk will also be at the surface of the water.
2. Head (ears specifically), hips and ankles in horizontal alignment.		2. Judgement is made by checking visual points of the horizontal alignment: ears, shoulder joints, hip joints and ankles. This imaginary line should also pass through the middle of the side of the trunk.

BP 14 Bent Knee Position




Body Position Description	Diagrams	Major Desired Actions
One leg bent with the toe of the bent leg in contact with the inside of the extended leg at the knee or higher.		The relationship of the toe of the bent leg to the extended leg may vary depending on the figure but should remain constant once established, and not extend in front of or behind the extended leg.
b) Bent Knee Back Layout Position		
1. Body extended in Back Layout Position .		1. In BP 1 Back Layout Position ears, shoulder joints, hip joints and ankle of extended leg in line at maximum horizontal alignment.
2. The thigh of the bent leg is perpendicular to the surface of the water.		2. 90° angle between the thigh and the surface of the water, and 90° angle maintained between the thigh and the trunk. At maximum height an air pocket will be evident between the back of the thigh and calf of the bent leg and the surface of the water.

Figure – 141 STINGRAY (cont.)
DIFFICULTY – 3.1
BP 3 Ballet Leg Position

Body Position Description	Diagrams	Major Desired Actions
a) Surface 1. Body in Back Layout Position . 2. One leg extended perpendicular to the surface of the water.		1. See BP 1 Back Layout Position . Ears, shoulder joints, hip joints and ankle of extended leg in line at maximum horizontal alignment. 2. 90° angle between the extended leg and the surface of the water and between the extended leg and the trunk with maximum horizontal alignment maintained throughout.

BP 4 Flamingo Position

Body Position Description	Diagrams	Major Desired Actions
a) Surface 1. One leg extended perpendicular to the surface of the water. 2. The other leg bent with the mid-calf opposite the vertical leg. Foot, shin and knee at and parallel to the surface of the water. 3. Face at the surface of the water.		1. 90° angle between the extended leg and the surface of the water. 2. The top of the bent leg from knee to toes should be dry with the vertical leg extended perpendicular midway between the knee and ankle of the horizontal leg. 3. Chest close to the surface of the water with the shoulders back. Ears, shoulder joints and hip joints aligned with the spine straight and extended.

BP 8 Fishtail Position

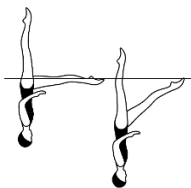


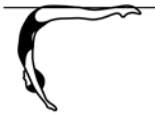
Body Position Description	Diagrams	Major Desired Actions
1. Body extended in Vertical Position with one leg extended forward. The foot of the forward leg is at the surface of the water regardless of the height of the hips.		1. See BP 6 Vertical Position for body alignment. The foot of the forward leg must be at the surface of the water. Hip joints must be on a horizontal line.

Figure – 141 STINGRAY (cont.)
DIFFICULTY – 3.1
BP 16 Split Position

Body Position Description	Diagrams	Major Desired Actions
1. Legs evenly split forward and back. 2. The legs are parallel to the surface of the water. 3. Lower back arched, with hips, shoulders and head on a vertical line. 4. 180° angle between the extended legs (flat split), with inside of each leg aligned on opposite sides of a horizontal line, regardless of the height of the hips.		1. Full extension of the legs at or above the surface of the water. 4. Flat split. Hip joints and shoulder joints on a horizontal line, with both of these alignments 'square' and parallel to each other.
a) Surface Split Position 1. Legs are dry at the surface of the water.		1. Full extension of the legs. Crotch and legs dry at the surface of the water.

BP 13 Surface Arch Position

Body Position Description	Diagrams	Major Desired Actions
1. Lower back arched with hips, shoulders and head on a vertical line.		1. Hip joints and shoulder joints on a horizontal line with both of these alignments 'square' and parallel to one another. Head (ears specifically) in line with shoulders.
2. Legs together and at the surface of the water.		2. Hips joints at the surface of the water.

BM 1 To Assume a Ballet Leg/A Ballet Leg is assumed




Basic Movement Description	NVT	Diagrams	Major Desired Actions
1. Begin in a Back Layout Position . One leg remains at the surface of the water throughout.			1. See BP 1 Back Layout Position .
2. The foot of the other leg is drawn along the inside of the extended leg to assume a Bent Knee Back Layout Position .	10.5		2. See BP 14b Bent Knee Back Layout Position . The toe of the bending leg remains in contact with the inside of the extended leg. Minimal drop in hips. Position is held only long enough to demonstrate control and accuracy.

Figure – 141 STINGRAY (cont.)
DIFFICULTY – 3.1
BM 1 To Assume a Ballet Leg/A Ballet Leg is assumed (cont.)

Basic Movement Description	NVT	Diagrams	Major Desired Actions
3. The bent leg is straightened without movement of the thigh to assume a Ballet Leg Position .	11.0		3.1 See BP 3a Surface Ballet Leg Position . Height remains constant throughout the movement. 3.2 The head and trunk remain stationary throughout.

BM 6 Walkouts




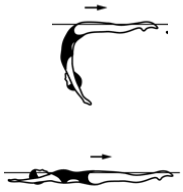
Basic Movement Description	NVT	Diagrams	Major Desired Actions
1. These movements start in a Split Position unless otherwise specified in the figure description. The hips remain stationary as one leg is lifted in an arc over the surface of the water to meet the opposite leg.			1. See BP 16a Surface Split Position .
a) Walkout Front			
2. The front leg is lifted in a 180° arc over the surface of the water to meet the opposite leg in a Surface Arch Position and with continuous movement an <i>Arch to Back Layout Finish Action</i> is executed.	23.0	 	2.1 Hip height remains constant and at the surface of the water. 2.2 Arcing leg moves continuously with uniform motion. 2.3 Both legs maintain full extension. 2.4 The trunk remains stationary until the feet join. 2.5 No pause in BP 13 Surface Arch Position , however an accurate surface arch must be evident before the body begins to rise and straighten. 2.6 Foot first surfacing motion begins when the feet are joined. 2.7 See BP 13 Surface Arch Position and BM 5 <i>Arch to Back Layout Finish Action</i> .
	7.0		

Figure – 141 STINGRAY (cont.)
DIFFICULTY – 3.1
BM 5 Arch to Back Layout Finish Action

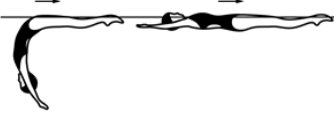
Basic Movement Description	NVT	Diagrams	Major Desired Actions
1. From a Surface Arch Position the hips, chest and face surface sequentially at the same point with foot first movement to a Back Layout Position until the head occupies the position of the hips at the beginning of this action.	7.0		1. See BP 13 Surface Arch Position . Sharp arch in the lower back. The body rises, straightens and moves along the surface of the water with a stationary BP 1 Back Layout Position achieved as the face surfaces. Full extension maintained throughout.

Figure – 142 MANTA RAY
DIFFICULTY – 2.8

A *Ballet Leg* is assumed. The shin of the horizontal leg is drawn along the surface of the water to assume a **Surface Flamingo Position**. With the ballet leg maintaining its vertical position, the hips are lifted as the trunk unrolls while the bent leg straightens with the knee at the surface of the water to assume a **Fishtail Position**. The horizontal leg is lifted rapidly in a 180° arc over the surface of the water. As it passes vertical, the vertical leg is lowered to assume a **Bent Knee Surface Arch Position**. The bent knee is straightened and with continuous motion an *Arch to Back Layout Finish Action* is executed.









								Total
NVT=	10.5	11.0	7.5	22.5	36.0	11.5	7.0	106
PV =	0.99	1.04	0.71	2.12	3.40	1.08	0.66	10





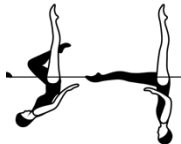



Figure Description	NVT	Diagrams	Major Desired Actions
1. A <i>Ballet Leg</i> is assumed.	10.5	 	1. See Figure 141 Stingray <i>BM 1 To Assume a Ballet Leg</i> .
2. The shin of the horizontal leg is drawn along the surface of the water to assume a Surface Flamingo Position .	11.0		2. See BP 4a Surface Flamingo Position . Height of the ballet leg remains constant.
Position .	7.5		

Figure – 142 MANTA RAY (cont.)
DIFFICULTY – 2.8

Figure Description	NVT	Diagrams	Major Desired Actions
<p>3. With the ballet leg maintaining its vertical position, the hips are lifted as the trunk unrolls while the bent leg straightens with the knee at the surface of the water to assume a Fishtail Position.</p> <p>It is important to note that the horizontal leg in the Flamingo Position becomes the horizontal leg in the Fishtail Position. The diagram shows the Flamingo Position to Fishtail Position movement performed with the left (L) leg shaded black however either leg can be used to perform the action.</p>	22.5		<p>3.1 See BP 8 Fishtail Position. The bent leg moves simultaneously to the Fishtail Position as the hips are lifted and the trunk unrolls.</p> <p>3.2 All actions are completed simultaneously as maximum height is achieved.</p> <p>3.3 BP 8 Fishtail Position is assumed under and in the same plane as the ballet leg of the BP 4a Surface Flamingo Position.</p>
<p>4. The horizontal leg is lifted rapidly in a 180° arc over the surface of the water. As it passes vertical, the vertical leg is lowered to assume a Bent Knee Surface Arch Position.</p> <p>It is important to note that the horizontal leg in the Fishtail Position must become the horizontal leg in the Bent Knee Surface Arch Position.</p> <p>The diagrams show the movement performed with the left leg (L) shaded black however either leg can be used to perform the action.</p>	36.0		<p>4.1 Height is maintained on the lift and pass through to the bent knee surface arch position.</p> <p>4.2 The horizontal leg is lifted rapidly in a 180° arc over the surface of the water. There is no pause as the legs pass through vertical position prior to the lowering action of the vertical leg to BP 14d Bent Knee Surface Arch Position.</p> <p>4.3 The Bent Knee Surface Arch Position is achieved by the lowering of the vertical leg as the 180° arc over the surface of the water is completed by the horizontal leg.</p>
<p>5. The bent knee is straightened and with continuous motion an <i>Arch to Back Layout Finish Action</i> is executed.</p>	11.5		<p>5.1 See BP 13 Surface Arch Position and BM 5 <i>Arch to Back Layout Finish Action</i>. Foot first surfacing action begins as soon as the feet are joined. The Surface Arch Position must be evident, but not held, prior to initiation of the arch-up action.</p>
	7.0		

See Figure 141 Stingray for **Back Layout Position, Bent Knee Back Layout Position, Ballet Leg Single Position, Flamingo Position, Fishtail Position, To Assume A Ballet Leg Basic Movement and Arch to Back Layout Finish Action Basic Movement**.

Figure – 142 MANTA RAY (cont.)
DIFFICULTY – 2.8
BP 14 Bent Knee Position


Body Position Description	Diagrams	Major Desired Actions
<p>One leg bent with the toe of the bent leg in contact with the inside of the extended leg at the knee or higher.</p>		<p>The relationship of the toe of the bent leg to the extended leg may vary depending on the figure but should remain constant once established, and not extend in front of or behind the extended leg.</p>
<p>d) Bent Knee Surface Arch Position</p>		
<p>1. Lower back arched with hips, shoulders and head on a vertical line.</p>		<p>1.1 In BP 13 Surface Arch Position shoulder joints and hip joints on a horizontal line with both of these alignments 'square' and parallel to one another. Head (ears specifically) in line with shoulders.</p> <p>1.2 Hips at the surface of the water.</p>
<p>2. The thigh of the bent leg is perpendicular to the surface of the water.</p>		<p>2. 90° angle between the thigh and the surface of the water. An air pocket will be evident between the back of the thigh and calf of the bent leg and the surface of the water.</p>

Figure – 143 RIO
DIFFICULTY – 3.1

A *Ballet Leg* is assumed. The knee, shin and toes of the horizontal leg are drawn along the surface of the water to assume a **Surface Flamingo Position**. The bent leg is straightened to a **Surface Ballet Leg Double Position**. The body submerges vertically to a **Back Pike Position** with the toes just under the surface of the water. A *Thrust* is executed to a **Vertical Position**. A *Spinning 360°* is executed at the same tempo as the *Thrust*.

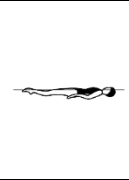
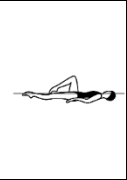

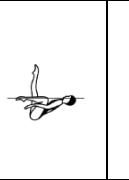
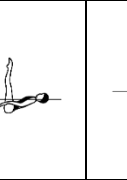
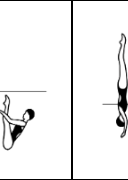
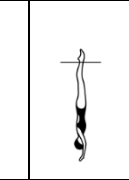
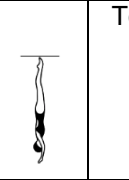
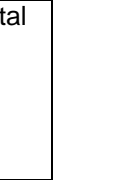
									Total
NVT=	10.5	11.0	7.5	13.0	12.0	31.0	39.0	0	124
PV =	0.85	0.89	0.60	1.05	0.97	2.50	3.15	0	10





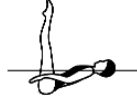

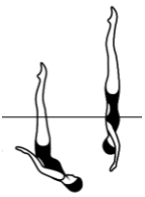



Figure Description	NVT	Diagrams	Major Desired Actions
1. A <i>Ballet Leg</i> is assumed.			1. See BM 1 <i>To Assume A Ballet Leg</i> .
	10.5		
	11.0		
2. The knee, shin and toes of the horizontal leg are drawn along the surface of the water to assume a Surface Flamingo Position .	7.5		2. See BP 4a Surface Flamingo Position . Height of the ballet leg remains constant.
3. The bent leg is straightened to a Surface Ballet Leg Double Position .	13.0		3. See BP 5a Surface Ballet Leg Double Position . This position is held only long enough to define the position and to demonstrate completion of the transition.
4. The body submerges vertically to a Back Pike Position with the toes just under the surface of the water.	12.0		4. As the body submerges maintaining the back straight and head in line, a submerged BP11 Back Pike Position is shown with the legs remaining on the vertical line. The legs and hips are directly beneath the position they occupied in the Surface Ballet Leg Double Position .

Figure – 143 RIO (cont.)
DIFFICULTY – 3.1

Figure Description	NVT	Diagrams	Major Desired Actions
5. A <i>Thrust</i> is executed to a Vertical Position .	31.0		5.1 See BM 9 <i>Thrust</i> . Obvious increase in speed. The body unrolls under the legs to assume BP 6 Vertical Position along the same perpendicular line established by the legs in the Back Pike Position . Maximum height and Vertical Position are achieved simultaneously, with full extension of the Vertical Position shown prior to initiation of the descent.
6. A <i>Spinning 360°</i> is executed at the same tempo as the <i>Thrust</i> to complete the figure.	39.0		
	0		6. See BM 13e <i>Spins</i> . Uniform rapid motion at the same rate of speed as the <i>Thrust</i> . After completion of the <i>360°Spin</i> , a <i>Vertical Descent</i> is executed at the same tempo as the spin.

Note: Refer to Section BM 13 Spins and Spin Allowance.


BP 1 Back Layout Position

Body Position Description	Diagrams	Major Desired Actions
1. Body extended with face, chest, thighs and feet at the surface of the water.		1. Gives the impression that the body is stretched horizontally to its maximum. Front of the trunk will also be at the surface of the water.
2. Head (ears specifically), hips and ankles in horizontal alignment.		2. Judgement is made by checking visual points of the horizontal alignment: ears, shoulder joints, hip joints and ankles. This imaginary line should also pass through the middle of the side of the trunk.


BP 14 Bent Knee Position

Body Position Description	Diagrams	Major Desired Actions
One leg bent with the toe of the bent leg in contact with the inside of the extended leg at the knee or higher.		The relationship of the toe of the bent leg to the extended leg may vary depending on the figure but should remain constant once established, and not extend in front of or behind the extended leg.

Figure – 143 RIO (cont.)
DIFFICULTY – 3.1
BP 14 Bent Knee Position (cont.)

Body Position Description	Diagrams	Major Desired Actions
b) Bent Knee Back Layout Position 1. Body extended in Back Layout Position . 2. The thigh of the bent leg is perpendicular to the surface of the water.		1. In BP 1 Back Layout Position ears, shoulder joints, hip joints and ankle of extended leg in line at maximum horizontal alignment. 2. 90° angle between the thigh and the surface of the water, and 90° angle maintained between the thigh and the trunk. At maximum height an air pocket will be evident between the back of the thigh and calf of the bent leg and the surface of the water.

BP 3 Ballet Leg Position

Body Position Description	Diagrams	Major Desired Actions
a) Surface 1. Body in Back Layout Position . 2. One leg extended perpendicular to the surface of the water.		1. See BP 1 Back Layout Position . Ears, shoulder joints, hip joints and ankle of extended leg in line at maximum horizontal alignment. 2. 90° angle between the extended leg and the surface of the water and between the extended leg and the trunk with maximum horizontal alignment maintained throughout.

BP 4 Flamingo Position



Body Position Description	Diagrams	Major Desired Actions
a) Surface 1. One leg extended perpendicular to the surface of the water. 2. The other leg bent with the mid-calf opposite the vertical leg. Foot, shin and knee at and parallel to the surface of the water.		1. 90° angle between the extended leg and the surface of the water. 2. The top of the bent leg from knee to toes should be dry with the vertical leg extended perpendicular midway between the knee and ankle of the horizontal leg.

Figure – 143 RIO (cont.)
DIFFICULTY – 3.1
BP 4 Flamingo Position (cont.)

Body Position Description	Diagrams	Major Desired Actions
3. Face at the surface of the water.		3. Chest close to the surface of the water with the shoulders back. Ears, shoulder joints and hip joints aligned with the spine straight and extended.

BP 5 Ballet Leg Double Position

Body Position Description	Diagrams	Major Desired Actions
a) Surface 1. Legs together and extended perpendicular to the surface of the water. 2. Head in line with the trunk. 3. Face at the surface of the water.		1. Full extension of the legs at a 90° angle to the surface of the water. 2. Chest close to the surface of the water with the shoulders back. Ears, hip joints and shoulder joints aligned, with the spine straight and extended.

BP 11 Back Pike Position



Body Position Description	Diagrams	Major Desired Actions
1. Body bent at hips to form an acute angle of 45° or less. 2. Legs extended and together. 3. Trunk extended with the back straight and head in line.		1. Legs close to chest while maintaining the straight line alignment of the extended spine and head. 2. Full extension of the legs, ankles and feet. 3. Back flat, with ears, shoulder joints, middle of side of torso, and hip joints aligned. Once the pike position is established the degree of the angle remains constant.

Figure – 143 RIO (cont.)
DIFFICULTY – 3.1
BP 6 Vertical Position

Body Position Description	Diagrams	Major Desired Actions
1. Body extended perpendicular to the surface of the water; legs together, head downward.		1. Full extension of the body.
2. Head (ears specifically), hips and ankles in line.		2. Judgement is made by checking visual points of the vertical alignment: ears, shoulder joints, hip joints and ankles.

BM 1 To Assume a Ballet Leg/A Ballet Leg is assumed




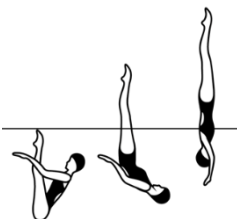
Basic Movement Description	NVT	Diagrams	Major Desired Actions
1. Begin in a Back Layout Position . One leg remains at the surface of the water throughout.			1. See BP 1 Back Layout Position .
2. The foot of the other leg is drawn along the inside of the extended leg to assume a Bent Knee Back Layout Position .	10.5		2. See BP 14b Bent Knee Back Layout Position . The toe of the bending leg remains in contact with the inside of the extended leg. Minimal drop in hips. Position is held only long enough to demonstrate control and accuracy.
3. The bent leg is straightened without movement of the thigh to assume a Ballet Leg Position .	11.0		3.1 See BP 3a Surface Ballet Leg Position . Height remains constant throughout the movement. 3.2 The head and trunk remain stationary throughout.

Figure – 143 RIO (cont.)
DIFFICULTY – 3.1
BM 9 Thrust

Basic Movement Description	NVT	Diagrams	Major Desired Actions
<p>1. From a Submerged Back Pike Position with the legs perpendicular to the surface of the water a vertical upward movement of the legs and hips is rapidly executed as the body unrolls to assume a Vertical Position.</p>	31.0		<p>1.1 See BP 11 Back Pike Position. The toes are just below the surface of the water. Once established, the degree of the angle of the pike position between the legs and the body must not change prior to initiation of the <i>Thrust</i>.</p> <p>1.2 See BP 6 Vertical Position. The body unrolls rapidly under the legs to assume BP 6 Vertical Position along the same perpendicular line to the surface of the water established by the legs in the BP 11 Back Pike Position.</p> <p>1.3 Obvious increase in speed from the initiation of body unrolling through the vertical upward movement.</p>
<p>2. Maximum height desirable.</p>			<p>2. Maximum height and BP 6 Vertical Position achieved simultaneously.</p>

BM 10 Vertical Descent - from ankle level

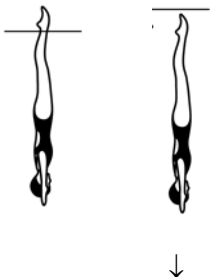
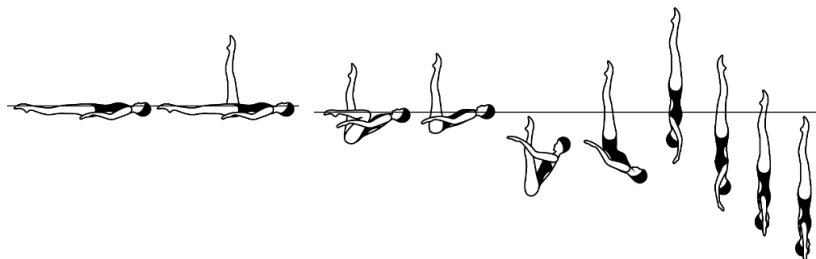
Basic Movement Description	NVT	Diagrams	Major Desired Actions
<p>1. Maintaining a Vertical Position the body descends along its longitudinal axis until the toes are submerged.</p>	0		<p>1. See BP 6 Vertical Position. The tempo of the descent is uniform and at the same speed as the rest of the figure.</p>

Figure – 144 RIO STRAIGHT LEG
DIFFICULTY – 3.1

A *Straight Ballet Leg* is assumed. The knee, shin and toes of the horizontal leg are drawn along the surface of the water to assume a **Surface Flamingo Position**. The bent leg is straightened to a **Surface Ballet Leg Double Position**. The body submerges vertically to a **Back Pike Position** with the toes just under the surface of the water. A *Thrust* is executed to a **Vertical Position**. A *Spinning 360°* is executed at the same tempo as the *Thrust*.







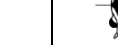



								Total
NVT=	18.5	7.5	13.0	12.0	31.0	39.0	0	121
PV =	1.53	0.62	1.07	0.99	2.56	3.22	0	10





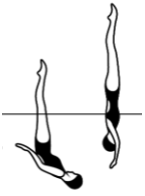


Figure Description	NVT	Diagrams	Major Desired Actions
1. A <i>Straight Ballet Leg</i> is assumed.	18.5		1. See BM1B To Assume A <i>Straight Ballet Leg</i> .
2. The knee, shin and toes of the horizontal leg are drawn along the surface of the water to assume a Surface Flamingo Position .	7.5		2. See BP 4a Surface Flamingo Position . Height of the ballet leg remains constant.
3. The horizontal leg is extended to a Surface Ballet Leg Double Position .	13.0		3. See BP 5a Surface Ballet Leg Double Position . This position is held only long enough to define the position and to demonstrate completion of the transition.

Figure – 144 RIO STRAIGHT LEG (cont.)
DIFFICULTY – 3.1

Figure Description	NVT	Diagrams	Major Desired Actions
4. The body submerges vertically to a Back Pike Position with the toes just under the surface of the water.	12.0		4. As the body submerges maintaining the back straight and head in line, a submerged BP 11 Back Pike Position is shown with the legs remaining on the vertical line. The legs and hips are directly beneath the position they occupied in the BP 5a Surface Ballet Leg Double Position .
5. A <i>Thrust</i> is executed to a Vertical Position .	31.0		5.1 See BM 9 <i>Thrust</i> . Obvious increase in speed. The body unrolls under the legs to assume BP 6 Vertical Position along the same perpendicular line established by the legs in the Back Pike Position . 5.2 Maximum height and Vertical Position are achieved simultaneously, with full extension of the Vertical Position shown prior to initiation of the descent.
6. A <i>Spinning 360°</i> is executed at the same tempo as the <i>Thrust</i> to complete the figure.	39.0	 	6. See BM 13e <i>Spins</i> . Uniform rapid motion at the same rate of speed as the <i>Thrust</i> . After completion of the <i>360°Spin</i> , a <i>Vertical Descent</i> is executed at the same tempo as the spin.

See Figure 143 Rio for **Back Layout Position, Ballet Leg Position, Flamingo Position, Ballet Leg Double Position, Back Pike Position, Vertical Positions, Thrust Basic Movement and Vertical Descent Basic Movement.**

Note: Refer to Section BM 13 Spins and Spin Allowance.

Figure – 144 RIO STRAIGHT LEG (cont.)
DIFFICULTY – 3.1
BM 1B To Assume a Straight Ballet Leg



Basic Movement Description	NVT	Diagrams	Major Desired Actions
1. From a Back Layout Position one leg is raised straight to a Ballet Leg Position .			1.1 See BP 1 Back Layout Position . Ears, shoulder joints, hip joints and ankles of extended legs at maximum horizontal alignment.
	18.5		1.2 One leg is raised straight to BP 3a Surface Ballet Leg Position while keeping the horizontal alignment of the horizontal leg and trunk with minimal drop of the hips. Uniform motion throughout. 1.3 The head and trunk remain stationary throughout.

Figure – 150 KNIGHT
DIFFICULTY – 3.1

A *Ballet Leg* is assumed. Maintaining the position of the legs, the head moves downward as the lower back arches to assume a **Knigh Position**. The back straightens as the non-ballet leg is simultaneously lifted to vertical. As the ballet leg bends the foot follows a vertical line through the hips to assume a **Bent Knee Vertical Position**. A *Half Twist* is executed. The back arches as the extended leg lowers to assume a **Bent Knee Surface Arch Position**. The bent knee is straightened and with continuous motion an *Arch to Back Layout Finish Action* is executed.










									Total
NVT=	10.5	11.0	25.0	21.0	15.0	19.0	11.5	7.0	120
PV =	0.88	0.92	2.08	1.75	1.25	1.58	0.96	0.58	10




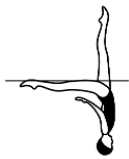
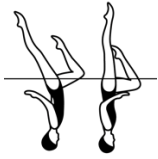


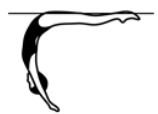



Figure Description	NVT	Diagrams	Major Desired Actions
1. A <i>Ballet Leg</i> is assumed.			1. See BM 1 To Assume A <i>Ballet Leg</i> .
	10.5		
	11.0		

Figure – 150 KNIGHT (cont.)
DIFFICULTY – 3.1

Figure Description	NVT	Diagrams	Major Desired Actions
2. Maintaining the position of the legs, the head moves downward as the lower back arches to assume a Knights Position .	25.0		2.1 See BP 17 Knights Position . Water level on the ballet leg remains constant. 2.2 The vertical leg maintains the same perpendicular line established in the Ballet Leg Position .
3. The back straightens as the non-ballet leg is simultaneously lifted to vertical. As the ballet leg bends, the foot follows a vertical line through the hips to assume a Bent Knee Vertical Position .	21.0		3. The non-ballet leg reaches the vertical simultaneously with the ballet leg achieving the BP 14c Bent Knee Vertical Position and with the trunk reaching vertical. Height remains constant throughout.
4. A <i>Half Twist</i> is executed.	15.0		4.1 See BM 12a <i>Half Twist</i> . The <i>Half Twist</i> is performed in a Bent Knee Vertical Position . 4.2 Height remains constant throughout.
5. The back arches as the extended leg lowers to assume a Bent Knee Surface Arch Position .	19.0		5. See BP 14d Bent Knee Surface Arch Position . Head remains aligned with hips. The water level and the position of the toe on the leg remains constant.
6. The bent knee is straightened and with continuous motion an <i>Arch to Back Layout</i> is executed.	11.5		6. See BP 13 Surface Arch Position and BM 5 <i>Arch to Back Layout Finish Action</i> . Foot first surfacing action begins as soon as the feet are joined. No pause, but the Surface Arch Position must be evident prior to the initiation of the arch-up action.
	7.0		

Note: Refer to Section BM 12 Twists & Twist Allowances.

Figure – 150 KNIGHT (cont.)
DIFFICULTY – 3.1
BP 1 Back Layout Position

Body Position Description	Diagrams	Major Desired Actions
1. Body extended with face, chest, thighs and feet at the surface of the water.		1. Gives the impression that the body is stretched horizontally to its maximum. Front of the trunk will also be at the surface of the water.
2. Head (ears specifically), hips and ankles in horizontal alignment.		2. Judgement is made by checking visual points of the horizontal alignment: ears, shoulder joints, hip joints and ankles. This imaginary line should also pass through the middle of the side of the trunk.

BP 14 Bent Knee Position



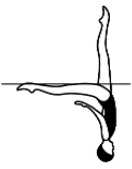
Body Position Description	Diagrams	Major Desired Actions
One leg bent with the toe of the bent leg in contact with the inside of the extended leg at the knee or higher.		The relationship of the toe of the bent leg to the extended leg may vary depending on the figure but should remain constant once established, and not extend in front of or behind the extended leg.
b) Bent Knee Back Layout Position		
1. Body extended in Back Layout Position .		1. In BP 1 Back Layout Position ears, shoulder joints, hip joints and ankle of extended leg in line at maximum horizontal alignment.
2. The thigh of the bent leg is perpendicular to the surface of the water.		2. 90° angle between the thigh and the surface of the water, and 90° angle maintained between the thigh and the trunk. At maximum height an air pocket will be evident between the back of the thigh and calf of the bent leg and the surface of the water.

Figure – 150 KNIGHT (cont.)
DIFFICULTY – 3.1
BP 3 Ballet Leg Position

Body Position Description	Diagrams	Major Desired Actions
<p>a) Surface</p> <p>1. Body in Back Layout Position.</p> <p>2. One leg extended perpendicular to the surface of the water.</p>		<p>1. See BP 1 Back Layout Position. Ears, shoulder joints, hip joints and ankle of extended leg in line at maximum horizontal alignment.</p> <p>2. 90° angle between the extended leg and the surface of the water and between the extended leg and the trunk with maximum horizontal alignment maintained throughout.</p>


BP 17 Knight Position

Body Position Description	Diagrams	Major Desired Actions
<p>1. Lower back arched, with hips, shoulders and head on a vertical line.</p> <p>2. One leg vertical.</p> <p>3. Other leg extended backward with the leg at the surface of the water and as close to horizontal as possible.</p>		<p>1. Arch is in the lower part of the spine only.</p> <p>2. Vertical alignment through ears, shoulder joints, hip joints and ankle of the vertical leg.</p> <p>3. Hip joints and shoulder joints on a horizontal line with both of these alignments 'square' and parallel to each other. The top of the horizontal extended leg faces upward.</p>


BP 14 Bent Knee Position

Body Position Description	Diagrams	Major Desired Actions
<p>One leg bent with the toe of the bent leg in contact with the inside of the extended leg at the knee or higher.</p>		<p>The relationship of the toe of the bent leg to the extended leg may vary depending on the figure but should remain constant once established, and not extend in front of or behind the extended leg.</p>

Figure – 150 KNIGHT (cont.)
DIFFICULTY – 3.1
BP 14 Bent Knee Position (cont.)

Body Position Description	Diagrams	Major Desired Actions
c) Bent Knee Vertical Position 1. Body extended in Vertical Position with the thigh of the bent leg parallel to the surface of the water.		1. In BP 6 Vertical Position the alignment of the extended leg, trunk and head remains constant.

BP 14 Bent Knee Position

Body Position Description	Diagrams	Major Desired Actions
d) Bent Knee Surface Arch Position 1. Lower back arched with hips, shoulders and head on a vertical line. 2. The thigh of the bent leg is perpendicular to the surface of the water.		1.1 In BP 13 Surface Arch Position shoulder joints and hip joints on a horizontal line with both of these alignments 'square' and parallel to one another. Head (ears specifically) in line with shoulders. 1.2 Hips at the surface of the water. 2. 90° angle between the thigh of the bent leg and the surface of the water. An air pocket will be evident between the back of the thigh and calf of the bent leg and the surface of the water.

BP 13 Surface Arch Position





Body Position Description	Diagrams	Major Desired Actions
1. Lower back arched with hips, shoulders and head on a vertical line. 2. Legs together and at the surface of the water.		1. Hip joints and shoulder joints on a horizontal line with both of these alignments 'square' and parallel to one another. Head (ears specifically) in line with shoulders. 2. Hips joints at the surface of the water.

Figure – 150 KNIGHT (cont.)
DIFFICULTY – 3.1
BM 1 To Assume a Ballet Leg/A Ballet Leg is assumed

Basic Movement Description	NVT	Diagrams	Major Desired Actions
1. Begin in a Back Layout Position . One leg remains at the surface of the water throughout.			1. See BP 1 Back Layout Position .
2. The foot of the other leg is drawn along the inside of the extended leg to assume a Bent Knee Back Layout Position .	10.5		2. See BP 14b Bent Knee Back Layout Position . The toe of the bending leg remains in contact with the inside of the extended leg. Minimal drop in hips. Position is held only long enough to demonstrate control and accuracy.
3. The bent leg is straightened without movement of the thigh to assume a Ballet Leg Position .	11.0		3.1 See BP 3a Surface Ballet Leg Position . Height remains constant throughout the movement. 3.2 The head and trunk remain stationary throughout.

BM 12 Twists a) Half Twist in Bent Knee Vertical Position – adapted

Basic Movement Description	NVT	Diagrams	Major Desired Actions
1. A <i>Twist</i> is a rotation at a sustained height.			1. Height remains constant throughout the rotation. Stability and alignment of the position is evident before, during and upon completion of the <i>Twist</i> . The amount of height is judged by the relationship of the hip joints to the surface of the water with maximum height desirable.
2. The body remains on its longitudinal axis throughout the rotation.			2. The longitudinal axis runs through the centre of the body and is perpendicular to the surface of the water. On the spot rotation around this axis.

Figure – 150 KNIGHT (cont.)
DIFFICULTY – 3.1

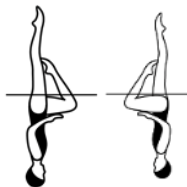
Basic Movement Description	NVT	Diagrams	Major Desired Actions
----------------------------	-----	----------	-----------------------

Half Twist in Bent Knee Vertical Position

4.

 a) **Half Twist:** a *Twist* of 180°.

15.0



See Twist Allowance.

 See BP 14c) **Bent Knee Vertical Position.**
BM 5 Arch to Back Layout Finish Action

Basic Movement Description	NVT	Diagrams	Major Desired Actions
----------------------------	-----	----------	-----------------------

 1. From a **Surface Arch Position** the hips, chest and face surface sequentially at the same point with foot first movement to a **Back Layout Position** until the head occupies the position of the hips at the beginning of this action.

7.0

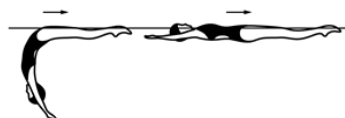

 1. See BP 13 **Surface Arch Position**. Sharp arch in the lower back. The body rises, straightens and moves along the surface of the water with a stationary BP 1 **Back Layout Position** achieved as the face surfaces. Full extension maintained throughout.

Figure – 154 LONDON
DIFFICULTY – 1.9

A *Ballet Leg* is assumed. A partial Somersault Back Tuck is executed until the shins are perpendicular to the surface of the water. The trunk unrolls rapidly as the legs are rapidly straightened to assume a **Vertical Position** midway between the former vertical line through the hips and the former vertical line through the head and the shins. A rapid *Vertical Descent* is executed.







						Total
NVT=	10.5	11.0	6.0	20.0	13.0	60.5
PV =	1.74	1.82	0.99	3.31	2.15	10

Figure Description	NVT	Diagrams	Major Desired Actions
--------------------	-----	----------	-----------------------

 1. A *Ballet Leg* is assumed

10.5

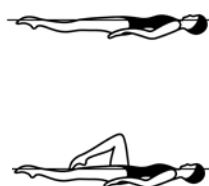





 1. See BM 1 *To Assume A Ballet Leg.*

Figure – 154 LONDON (cont.)
DIFFICULTY – 1.9

Figure Description	NVT	Diagrams	Major Desired Actions
1. A <i>Ballet Leg</i> is assumed	11.0		
2. A partial Somersault Back Tuck is executed until the shins are perpendicular to the surface of the water.	6.0		2. BP 9 inverted Tuck Position is achieved.
3. The trunk unrolls rapidly as the legs are rapidly straightened to assume a Vertical Position midway between the former vertical line through the hips and the former vertical line through the head and the shins.	20.0		3.1 The trunk unrolls rapidly with BP 6 Vertical Position and maximum height achieved simultaneously. 3.2 The Vertical Position is held only long enough to define the position and to demonstrate completion of the transition prior to the descent.
4. A rapid <i>Vertical Descent</i> is executed.	13.0		4. See BM 10 <i>Vertical Descent</i> (rapid).

See Figure 115 Knight for **Back Layout Position, Bent Knee Back Layout Position, Ballet Leg Position** and BM 1 *To Assume A Ballet Leg Basic Movement*.

BP 9 Tuck Position





Body Position Description	Diagrams	Major Desired Actions
1. Body as compact as possible, with the back rounded and the legs together.		1. Legs together with shins at the surface of the water and tucked tightly to the front of the body.
2. Heels close to buttocks.		2. Compact tuck. Chin tucked in.
3. Head close to knees.		3. In BP 9 inverted Tuck Position , shins are perpendicular to the surface of the water, buttocks remain at the surface and the water level is between the ankle and mid foot.

Figure – 154 LONDON (cont.)
DIFFICULTY – 1.9
BP 6 Vertical Position

Body Position Description	Diagrams	Major Desired Actions
1. Body extended perpendicular to the surface of the water; legs together, head downward.		1. Full extension of the body.
2. Head (ears specifically), hips and ankles in line.		2. Judgement is made by checking visual points of the vertical alignment: ears, shoulder joints, hip joints and ankles.

BM 10 Vertical Descent-rapid

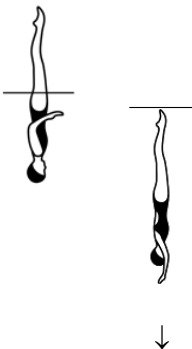




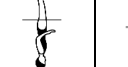



Basic Movement Description	NVT	Diagrams	Major Desired Actions
1. Maintaining a Vertical Position the body descends along its longitudinal axis until the toes are submerged.	13.0		1. See BP 6 Vertical Position . The <i>Vertical Descent</i> is performed rapidly.

Figure – 154 LONDON (cont.)









London 154j-1 and 154j-2 – A London is executed to **Vertical Position**. A rapid designated *Spin* is executed. A rapid *Vertical Descent* is executed.

Figure –154j-1 LONDON COMBINED SPIN (360° + 360°)* DIFFICULTY – 2.7

									Total
NVT=	10.5	11.0	6.0	20.0	42.0	13.0		102.5	
PV =	1.02	1.07	0.59	1.95	4.10	1.27		10	

***Note: Refer to Section BM 13 Spins. There is no Spin Allowance for Combined Spins.**

Figure – 154j-2 LONDON COMBINED SPIN (720° + 720°)* DIFFICULTY – 2.9

									Total
NVT=	10.5	11.0	6.0	20.0	50.0	13.0		110.5	
PV =	0.95	1.00	0.54	1.81	4.52	1.18		10	

***Note: Refer to Section BM 13 Spins. There is no Spin Allowance for Combined Spins.**



Artistic Swimming Figures Manual

2022 – 2025

Part 2

Category II

CATEGORY II		
226	Swan	2.1
227	Swanita	1.8
227d	Swanita Spinning 180°	1.9
240	Albatross	2.2
240a	Albatross ½ Twist	2.2
240b	Albatross Full Twist	2.3
240c	Albatross Twirl	2.3
240d	Albatross Spinning 180°	1.9
240e	Albatross Spinning 360°	2.0
240h	Albatross Spin Up 180°	2.4
240i	Albatross Spin Up 360°	2.5
240j	Albatross Combined Spin (360°+360°)	2.6
241	Goeland	2.0

Figure – 226 SWAN

DIFFICULTY – 2.1

From a **Back Layout Position** a *Bent Knee Surface Arch Position* is assumed. The bent leg is straightened to assume a **Knight Position**. The body rotates 180° to assume a **Fishtail Position**. The vertical leg is lowered to the surface of the water to meet the opposite leg in a **Front Pike Position**. With continuous movement the body is straightened to a **Front Layout Position**.



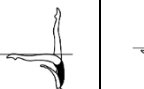
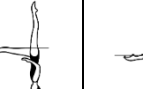


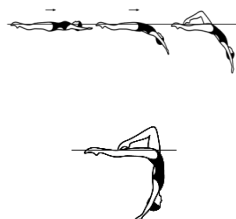
						Total
NVT=	17.5	14.0	14.0	14.5	6.0	66
PV =	2.65	2.12	2.12	2.20	0.91	10

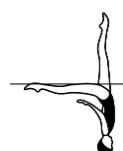
Figure Description	NVT	Diagrams	Major Desired Actions
--------------------	-----	----------	-----------------------

1. From a **Back Layout Position** a *Bent Knee Surface Arch Position* is assumed. 17.5



1. See BP 1 **Back Layout Position**, BP 14d **Bent Knee Surface Arch Position** and BM 15 *To Assume A Bent Knee Surface Arch Position*. Continuous uniform movement from **Back Layout Position** to **Bent Knee Surface Arch Position**.

2. The bent leg is straightened to assume a **Knight Position**. 14.0



2.1 See BP 17 **Knight Position**. Horizontal alignment of hips and shoulders 'square' and maintained during the lift to **Knight Position**.
 2.2 Height remains constant during the straightening of the leg to **Knight Position** with full extension of the horizontal leg maintained.
 2.3 The bent leg is straightened along the vertical line established by the thigh in the **Bent Knee Surface Arch Position**.

Figure – 226 SWAN (cont.)

DIFFICULTY – 2.1

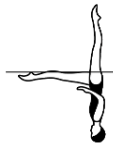

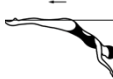



Figure Description	NVT	Diagrams	Major Desired Actions
3. The body rotates 180° to assume a Fishtail Position .	14.0		<p>3.1 See BP 8 Fishtail Position. The vertical leg remains stationary and height remains constant during the rotation.</p> <p>3.2 The foot of the horizontal leg remains at the surface of the water and not above or below.</p> <p>3.3 Full extension of the horizontal leg throughout the 180° rotation.</p>
4. The vertical leg is lowered to the surface of the water to meet the opposite leg in a Front Pike Position .	14.5		<p>4.1 See BP 10 Front Pike Position. Without loss of height and horizontal alignment of the head, hips and shoulders, the vertical leg is lowered to assume a Front Pike Position.</p> <p>4.2 The trunk remains stationary along the vertical line established in the Fishtail Position.</p>
5. With continuous movement the body is straightened to a Front Layout Position .	6.0	 	<p>5.1 See BP 2 Front Layout Position. An accurate BP 10 Front Pike Position should be evident before the body begins to straighten and rise however there is no pause in this position.</p> <p>5.2 The body straightens, rises and moves along the surface of the water with a stationary Front Layout Position achieved as the head surfaces.</p> <p>5.3 The head surfaces at the point occupied by the hips at the beginning of this action.</p>

Figure – 226 SWAN (cont.)
DIFFICULTY – 2.1
BP 1 Back Layout Position

Body Position Description	Diagrams	Major Desired Actions
1. Body extended with face, chest, thighs and feet at the surface of the water.		1. Gives the impression that the body is stretched horizontally to its maximum. Front of the trunk will also be at the surface of the water.
2. Head (ears specifically), hips and ankles in horizontal alignment.		2. Judgement is made by checking visual points of the horizontal alignment: ears, shoulder joints, hip joints and ankles. This imaginary line should also pass through the middle of the side of the trunk.

BP 14 Bent Knee Position

Body Position Description	Diagrams	Major Desired Actions
One leg bent with the toe of the bent leg in contact with the inside of the extended leg at the knee or higher.		The relationship of the toe of the bent leg to the extended leg may vary depending on the figure but should remain constant once established, and not extend in front of or behind the extended leg.

d) Bent Knee Surface Arch Position

1. Lower back arched, with hips, and head on a vertical line. shoulders



2. The thigh of the bent leg is perpendicular to the surface of the water.

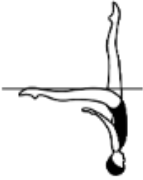
1.1 In BP 13 **Surface Arch Position** shoulder joints and hip joints on a horizontal line with both of these alignments 'square' and parallel to one another. Head (ears specifically) in line with shoulders.
1.2 Hips at the surface of the water.

2. 90° angle between the thigh of the bent leg and the surface of the water. An air pocket will be evident between the back of the thigh and calf of the bent leg and the surface of the water.

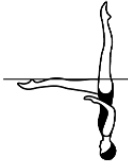
Figure – 226 SWAN (cont.)

DIFFICULTY – 2.1

BP 17 Knight Position

Body Position Description	Diagrams	Major Desired Actions
1. Lower back arched, with hips, shoulders and head on a vertical line.		1. Arch is in the lower part of the spine only.
2. One leg vertical.		2. Vertical alignment through ears, shoulder joints, hip joints and ankle of the vertical leg.
3. Other leg extended backward with the leg at the surface of the water and as close to horizontal as possible.		3. Hip joints and shoulder joints on a horizontal line with both of these alignments 'square' and parallel to each other. The top of the horizontal extended leg faces upward.

BP 8 Fishtail Position

Body Position Description	Diagrams	Major Desired Actions
1. Body extended in Vertical Position with one leg extended forward. The foot of the forward leg is at the surface of the water regardless of the height of the hips.		1. See BP 6 Vertical Position for body alignment. The foot of the forward leg must be at the surface of the water. Hip joints must be on a horizontal line.

BP 10 Front Pike Position




Body Position Description	Diagrams	Major Desired Actions
1. Body bent at hips to form a 90° angle.		1. Exact 90° angle.
2. Legs extended and together.		2. Full extension of legs, with ankles aligned with hip joints.
3. Trunk extended with the back straight and head in line.		3. Back flat, with vertical alignment of ears, shoulder joints and hip joints once the position is established.

Figure – 226 SWAN (cont.)

DIFFICULTY – 2.1

BP 2 Front Layout Position

Body Position Description	Diagrams	Major Desired Actions
1. Body extended with head, upper back, buttocks and heels at the surface of the water.		1. Gives the impression that the body is stretched horizontally to its maximum. Judgement made by checking visual points of the horizontal alignment: ears, shoulder joints, hip joints and heels.
2. Unless otherwise specified, face may be in or out of the water.		2. Once the head position is established as in or out of the water the position is maintained. When the face is out of the water the ears will not be on the horizontal axis and the back may be slightly lower and arched. Hip joints, calves and heels remain at the surface of the water.

BM 15 To Assume a Bent Knee Surface Arch Position/A Bent Knee Surface Arch is Assumed

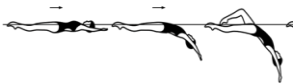

Basic Movement Description	NVT	Diagrams	Major Desired Actions
1. From a Back Layout Position with the head leading, the head, hips and feet move along the surface of the water.			1. See BP 1 Back Layout Position .
2. With continuous movement the head leaves the surface of the water as the back is arched more to assume a Bent Knee Surface Arch Position with the hips occupying the position of the head at the beginning of this action.	17.5		2.1 Continuous uniform movement from the BP 1 Back Layout Position to BP 14d Bent Knee Surface Arch Position . Hip height remains constant. Hip joints on a horizontal line. 2.2 The toe of the bent leg must remain in contact with the inside of the extended leg while assuming the Bent Knee Surface Arch Position .

Figure – 227 SWANITA

DIFFICULTY – 1.8

From a **Back Layout Position** a *Bent Knee Surface Arch Position* is assumed. The bent leg is straightened to assume a **Knight Position**. The body rotates 180° to assume a **Fishtail Position**. The legs join to assume a **Vertical Position** while descending to ankle level. A *Vertical Descent* is executed.






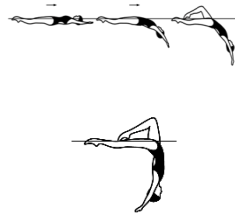
						Total
NVT=	17.5	14.0	14.0	8.5	0	54
PV =	3.24	2.59	2.59	1.57	0	10

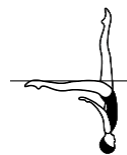
Figure Description	NVT	Diagrams	Major Desired Actions
--------------------	-----	----------	-----------------------

1. From a **Back Layout Position** a *Bent Knee Surface Arch Position* is assumed. 17.5



1. See BP 1 **Back Layout Position**, BP 14d **Bent Knee Surface Arch Position** and BM 15 *To Assume A Bent Knee Surface Arch Position*. Continuous uniform movement from **Back Layout Position** to **Bent Knee Surface Arch Position**.

2. The bent leg is straightened to assume a **Knight Position**. 14.0



2.1 See BP 17 **Knight Position**. Horizontal alignment of hips and shoulders 'square' and maintained during the lift to **Knight Position**.
 2.2 Height remains constant during the straightening of the leg to **Knight Position** with full extension of the horizontal leg maintained throughout.
 2.3 The bent leg is straightened along the vertical line established by the thigh in the **Bent Knee Surface Arch Position**.

Figure – 227 SWANITA (cont.)

DIFFICULTY – 1.8

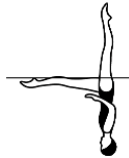



Figure Description	NVT	Diagrams	Major Desired Actions
3. The body rotates 180° to assume a Fishtail Position .	14.0		<p>3.1 See BP 8 Fishtail Position. The vertical leg remains stationary and height remains constant during the rotation.</p> <p>3.2 The foot of the horizontal leg remains at the surface of the water and not above or below.</p> <p>3.3 Full extension of the horizontal leg throughout the 180° rotation.</p>
4. The legs join to assume a Vertical Position while descending to ankle level.	8.5		<p>4.1 See BP 6 Vertical Position. The legs join while descending to assume a Vertical Position at ankle level.</p> <p>4.2 Stability and control evident throughout. The tempo of the descent is uniform and at the same speed as the rest of the figure.</p> <p>4.3 The joining of the legs to vertical and achieving the vertical position at ankle level occurs simultaneously.</p>
5. A <i>Vertical Descent</i> is executed.	0		<p>5. See BM 10 <i>Vertical Descent</i>. The tempo of the descent remains uniform and at the same speed as the rest of the figure through submergence.</p>

Figure – 227 SWANITA (cont.)

DIFFICULTY – 1.8

BP 1 Back Layout Position

Body Position Description	Diagrams	Major Desired Actions
<p>1. Body extended with face, chest, thighs and feet at the surface of the water.</p>		<p>1. Gives the impression that the body is stretched horizontally to its maximum. Front of the trunk will also be at the surface of the water.</p>
<p>2. Head (ears specifically), hips and ankles in horizontal alignment.</p>		<p>2. Judgement is made by checking visual points of the horizontal alignment: ears, shoulder joints, hip joints and ankles. This imaginary line should also pass through the middle of the side of the trunk.</p>

BP 14 Bent Knee Position

Body Position Description	Diagrams	Major Desired Actions
<p>One leg bent with the toe of the bent leg in contact with the inside of the extended leg at the knee or higher.</p>		<p>The relationship of the toe of the bent leg to the extended leg may vary depending on the figure but should remain constant once established, and not extend behind the leg.</p>

d) Bent Knee Surface Arch Position



<p>1. Lower back arched with hips, shoulders and head on a vertical line.</p>		<p>1.1 In BP 13 Surface Arch Position shoulder joints and hip joints on a horizontal line with both of these alignments 'square' and parallel to one another. Head (ears specifically) in line with shoulders. 1.2 Hips at the surface of the water.</p>
<p>2. The thigh of the bent leg is perpendicular to the surface of the water.</p>		<p>2. 90° angle between the thigh of the bent leg and the surface of the water. An air pocket will be evident between the back of the thigh and calf of the bent leg and the surface of the water.</p>

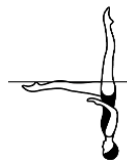
Figure – 227 SWANITA (cont.)

DIFFICULTY – 1.8

BP 17 Knight Position

Body Position Description	Diagrams	Major Desired Actions
<p>1. Lower back arched, with hips, shoulders and head on a vertical line.</p>		<p>1. Arch is in the lower part of the spine only.</p>
<p>2. One leg vertical.</p>		<p>2. Vertical alignment through ears, shoulder joints, hip joints and ankle of the vertical leg.</p>
<p>3. Other leg extended backward with the leg at the surface of the water and as close to horizontal as possible.</p>		<p>3. Hip joints and shoulder joints on a horizontal line with both of these alignments 'square' and parallel to each other. The top of the horizontal extended leg faces upward.</p>

BP 8 Fishtail Position

Body Position Description	Diagrams	Major Desired Actions
<p>1. Body extended in Vertical Position with one leg extended forward. The foot of the forward leg is at the surface of the water regardless of the height of the hips.</p>		<p>1. See BP 6 Vertical Position for body alignment. The foot of the forward leg must be at the surface of the water. Hip joints must be on a horizontal line.</p>

BP 6 Vertical Position-ankle level




Body Position Description	Diagrams	Major Desired Actions
<p>1. Body extended perpendicular to the surface of the water; legs together, head downward.</p>		<p>1. Full extension of the body with the water level at the ankles.</p>
<p>2. Head (ears specifically), hips and ankles in line.</p>		<p>2. Judgement is made by checking visual points of the vertical alignment: ears, shoulder joints, hip joints and ankles.</p>

Figure – 227 SWANITA (cont.)

DIFFICULTY – 1.8

BM 15 To Assume a Bent Knee Surface Arch Position/A Bent Knee Surface Arch is Assumed

Basic Movement Description	NVT	Diagrams	Major Desired Actions
<p>1. From a Back Layout Position with the head leading, the head, hips and feet move along the surface of the water.</p>			<p>1. See BP 1 Back Layout Position.</p>
<p>2. With continuous movement the head leaves the surface of the water as the back is arched more to assume a Bent Knee Surface Arch Position with the hips occupying the position of the head at the beginning of this action.</p>	17.5		<p>2.1 Continuous uniform movement from the BP 1 Back Layout Position to BP 14d Bent Knee Surface Arch Position. Hip height remains constant. Hip joints on a horizontal line.</p> <p>2.2 The toe of the bent leg must remain in contact with the inside of the extended leg while assuming the Bent Knee Surface Arch Position.</p>

BM 10 Vertical Descent – from ankle level

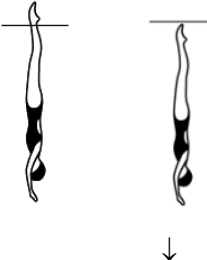
Basic Movement Description	NVT	Diagrams	Major Desired Actions
<p>1. Maintaining a Vertical Position the body descends along its longitudinal axis until the toes are submerged.</p>	0		<p>1. See BP 6 Vertical Position. The tempo of the descent is uniform and at the same speed as the rest of the figure.</p>

Figure – 227d SWANITA SPINNING 180°

DIFFICULTY – 1.9

From a **Back Layout Position** a *Bent Knee Surface Arch Position* is assumed. The bent leg is straightened to assume a **Knight Position**. The body rotates 180° to assume a **Fishtail Position**. Continuing in the same direction a descending *Spinning 180°* rotation is executed as the horizontal leg is lifted to a **Vertical Position** and is completed as the ankles reach the surface of the water. A *Vertical Descent* is executed.







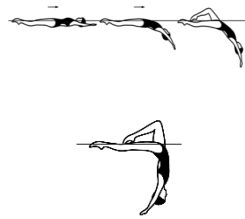
							Total
NVT=	17.5	14.0	14.0	12.5	0	0	58
PV =	3.02	2.41	2.41	2.16	0	0	10

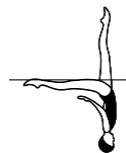
Figure Description	NVT	Diagrams	Major Desired Actions
--------------------	-----	----------	-----------------------

1. From a **Back Layout Position** a *Bent Knee Surface Arch Position* is assumed. 17.5



1. See BP 1 **Back Layout Position**, BP 14d **Bent Knee Surface Arch Position** and BM 15 *To Assume A Bent Knee Surface Arch Position*. Continuous uniform movement from **Back Layout Position** to **Bent Knee Surface Arch Position**.


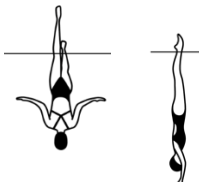

2. The bent leg is straightened to assume a **Knight Position**. 14.0



2.1 See BP 17 **Knight Position**. Horizontal alignment of hips and shoulders 'square' and maintained during the lift to **Knight Position**.
 2.2 Height remains constant during the straightening of the leg to **Knight Position** with full extension of the horizontal leg maintained.
 2.3 The bent leg is straightened along the vertical line established by the thigh in the **Bent Knee Surface Arch Position**.

Figure – 227d SWANITA SPINNING 180° (cont.)

DIFFICULTY – 1.9

Figure Description	NVT	Diagrams	Major Desired Actions
3. The body rotates 180° to assume a Fishtail Position .	14.0		<p>3.1 See BP 8 Fishtail Position. The vertical leg remains stationary and height remains constant during the rotation.</p> <p>3.2 The foot of the horizontal leg remains at the surface of the water and not above or below.</p> <p>3.3 Full extension of the horizontal leg throughout the 180° rotation.</p>
4. Continuing in the same direction a descending <i>Spinning 180°</i> rotation is executed as the horizontal leg is lifted to a Vertical Position and is completed as the ankles reach the surface of the water.	12.5		<p>4.1 The legs are joined while descending and rotating to assume a BP 6 Vertical Position at ankle level.</p> <p>4.2 The vertical leg maintains the vertical line throughout the rotation.</p> <p>4.3 Longitudinal axis is maintained throughout the rotation.</p> <p>4.4 The tempo of the rotation and descent is uniform and at the same speed as the root figure.</p>
5. A <i>Vertical Descent</i> is executed.	0		<p>5. See BM 10 <i>Vertical Descent</i>. The tempo of the descent is uniform and at the same speed as the rest of the figure.</p>

See Figure 227 Swanita for Back Layout Position, Bent Knee Surface Arch Position, Knight Position, Fishtail Position, Vertical Position-ankle level, BM 15 *To Assume a Bent Knee Surface Arch Position/A Bent Knee Surface Arch is Assumed Basic Movement* and BM 10 *Vertical Descent Basic Movement*.

Note: Refer to Section BM 13 Spins & Spin Allowances.

Figure – 240 ALBATROSS

DIFFICULTY – 2.2

From a **Back Layout Position** with the head leading, the head, hips and feet move along the surface of the water. The hips, legs and feet continue to move along the surface of the water as the body rolls onto the face and a *Front Pike Position* is assumed with the hips occupying the position of the head at the beginning of this action. The legs are lifted simultaneously to a **Bent Knee Vertical Position**. A *Half Twist* is executed. The bent leg is extended to **Vertical Position**. A *Vertical Descent* is executed.







						Total
NVT=	15.0	15.0	15.0	16.5	14.0	75.5
PV =	1.99	1.99	1.99	2.19	1.85	10

Figure Description	NVT	Diagrams	Major Desired Actions
--------------------	-----	----------	-----------------------

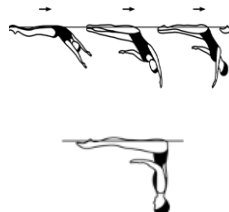
1. From a **Back Layout Position** with the head leading, the head, hips and feet move along the surface of the water.



1. See BP 1 **Back Layout Position** and BM 3 To Assume a *Front Pike Position*.

2. The hips, legs and feet continue to move along the surface of the water as the body rolls onto the face and a *Front Pike Position* is assumed with the hips occupying the position of the head at the beginning of this action.

15.0



2.1 See BP 10 **Front Pike Position** and BM 3 To Assume a *Front Pike Position*.
The body roll, trunk descent and hip movement along the surface of the water occurs simultaneously, with the transition completed as the trunk becomes vertical and the hips replace the head at the surface of the water.
2.2 The hips and head lock into the **Front Pike Position** simultaneously.

3. The legs are lifted simultaneously to a **Bent Knee Vertical Position**.




15.0



3. See BP 14c **Bent Knee Vertical Position**.
The trunk remains on the vertical line.
The **Bent Knee Vertical Position** is achieved as the vertical is reached.

Figure – 240 ALBATROSS (cont.)

DIFFICULTY – 2.2

Figure Description	NVT	Diagrams	Major Desired Actions
4. A <i>Half Twist</i> is executed.	15.0		4. See BM 12a <i>Half Twist</i> . The <i>Half Twist</i> is performed in a Bent Knee Vertical Position .
5. The bent leg is extended to Vertical Position .	16.5		5. BP 6 Vertical Position . Height and body alignment remain constant during extension of the bent leg.
6. A <i>Vertical Descent</i> is executed	14.0		6. See BM 10 <i>Vertical Descent</i> .

Note: Refer to Section BM 12 Twists & Clarification on Twists.

Body Position Description	Diagrams	Major Desired Actions
---------------------------	----------	-----------------------

BP 1 Back Layout Position

1. Body extended with face, chest, thighs and feet at the surface of the water.



1. Gives the impression that the body is stretched horizontally to its maximum. Front of the trunk will also be at the surface of the water.

2. Head (ears specifically), hips and ankles in horizontal alignment.

2. Judgement is made by checking visual points of the horizontal alignment: ears, shoulder joints, hip joints and ankles. This imaginary line should also pass through the middle of the side of the trunk.

BP 10 Front Pike Position

Body Position Description	Diagrams	Major Desired Actions
---------------------------	----------	-----------------------

1. Body bent at hips to form a 90° angle.



1. Exact 90° angle.

2. Legs extended and together.

2. Full extension of legs, with ankles aligned with hip joints.


Figure – 240 ALBATROSS (cont.)

DIFFICULTY – 2.2

BP 10 Front Pike Position (cont.)

Body Position Description	Diagrams	Major Desired Actions
3. Trunk extended with the back straight and head in line.		3. Back flat, with vertical alignment of ears, shoulder joints and hip joints once the position is established.

BP 14 Bent Knee Position

Body Position Description	Diagrams	Major Desired Actions
One leg bent with the toe of the bent leg in contact with the inside of the extended leg at the knee or higher.		The relationship of the toe of the bent leg to the extended leg may vary depending on the figure but should remain constant once established, and not extend in front of or behind the extended leg.

c) Bent Knee Vertical Position

1. Body extended in **Vertical Position** with the thigh of the bent leg parallel to the surface of the water.



1. In BP 6 **Vertical Position** the alignment of the extended leg, trunk and head remains constant.

BP 6 Vertical Position



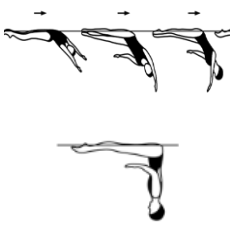
Body Position Description	Diagrams	Major Desired Actions
1. Body extended perpendicular to the surface of the water; legs together, head downward.		1. Full extension of the body.
2. Head (ears specifically), hips and ankles in line.		2. Judgement is made by checking visual points of the vertical alignment: ears, shoulder joints, hip joints and ankles.

Figure – 240 ALBATROSS (cont.)

DIFFICULTY – 2.2

BM 3 To Assume a Front Pike Position – adapted from Back Layout Position

Basic Movement Description	NVT	Diagrams	Major Desired Actions
<p>1. From a Back Layout Position with the head leading, the head, hips and feet move along the surface of the water.</p>			<p>1. See BP 1 Back Layout Position. Uniform motion in downward movement of the trunk. Continuous uniform movement from Back Layout Position.</p>
<p>2. The hips, legs and feet continue to move along the surface of the water as the body rolls onto the face and a <i>Front Pike Position is assumed</i> with the hips occupying the position of the head at the beginning of this action.</p>	<p>15.0</p>		<p>2. See BP 10 Front Pike Position and BM 3 <i>To Assume a Front Pike Position</i>. Uniform motion in downward movement of the trunk. The body roll, trunk descent and hip movement along the surface of the water occurs simultaneously. The hips and head lock into the Front Pike Position simultaneously.</p>

BM 12 Twists a) Half Twist in Bent Knee Vertical Position – adapted

Basic Movement Description	NVT	Diagrams	Major Desired Actions
<p>1. A <i>Twist</i> is a rotation at a sustained height.</p>			<p>1. Height remains constant throughout the rotation. Stability and alignment of the position is evident before, during and upon completion of the <i>Twist</i>. The amount of height is judged by the relationship of the hip joints to the surface of the water with maximum height desirable.</p>
<p>2. The body remains on its longitudinal axis throughout the rotation.</p>			<p>2. The longitudinal axis runs through the centre of the body and is perpendicular to the surface of the water. On the spot rotation around this axis.</p>

Figure – 240 ALBATROSS (cont.)

DIFFICULTY – 2.2

BM 12 Twists a) Half Twist in Bent Knee Vertical Position – adapted (cont.)

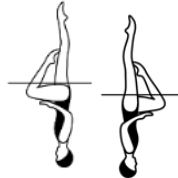
Basic Movement Description	NVT	Diagrams	Major Desired Actions
----------------------------	-----	----------	-----------------------

Half Twist in Bent Knee Vertical Position

4.

a) **Half Twist:** a *Twist* of 180°.

15.0



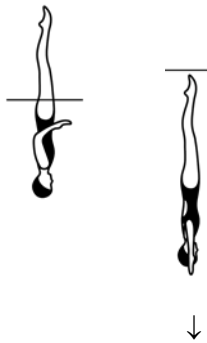
4. The **Bent Knee Position** is maintained throughout the *Half Twist*.

BM 10 Vertical Descent

Basic Movement Description	NVT	Diagrams	Major Desired Actions
----------------------------	-----	----------	-----------------------

1. Maintaining a **Vertical Position** the body descends along its longitudinal axis until the toes are submerged.

14.0



1. See BP 6 **Vertical Position**. The tempo of the descent is uniform and at the same speed as the rest of the figure.

Albatross 240a – 240c – An Albatross is executed until the *Half Twist* is completed. The designated *Twist* is executed as the bent leg is extended to meet the vertical leg. A *Vertical Descent* is executed.

Note: Refer to Section BM 12 Twists & Twist Allowances.

Figure – 240a ALBATROSS ½ TWIST

DIFFICULTY – 2.2

						Total
NVT=	15.0	15.0	15.0	16.5	14.0	75.5
PV =	1.99	1.99	1.99	2.19	1.85	10

Figure – 240 ALBATROS (cont.)

Albatross 240a – 240c – An Albatross is executed until the *Half Twist* is completed. The designated *Twist* is executed as the bent leg is extended to meet the vertical leg. A *Vertical Descent* is executed.

Note: Refer to Section BM 12 Twists & Twist Allowances.

Figure – 240b ALBATROSS FULL TWIST
DIFFICULTY – 2.3

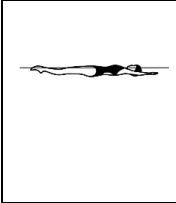



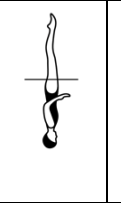
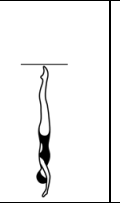
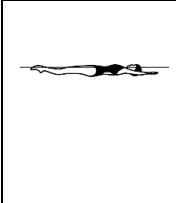



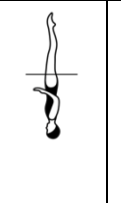
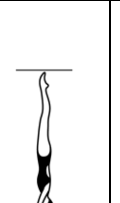
						Total
NVT=	15.0	15.0	15.0	22.0	14.0	81
PV =	1.85	1.85	1.85	2.72	1.73	10

Figure – 240c ALBATROSS TWIRL
DIFFICULTY – 2.3

						Total
NVT=	15.0	15.0	15.0	21.5	14.0	80.5
PV =	1.86	1.86	1.86	2.67	1.74	10

Albatross 240d and 240e – An Albatross is executed until the *Half Twist* is completed. The designated *Spin* is executed as the bent leg is extended to meet the vertical leg.

Note: Refer to Section BM 13 Spins & Spin Allowances.

Figure – 240d ALBATROSS SPINNING 180°
DIFFICULTY – 1.9

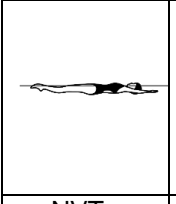


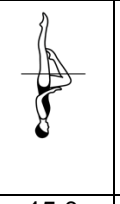
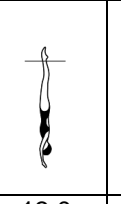
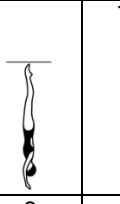
						Total
NVT=	15.0	15.0	15.0	13.0	0	58
PV =	2.59	2.59	2.59	2.24	0	10

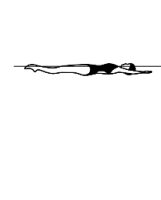

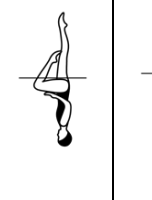
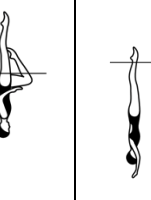
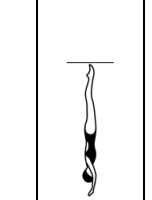
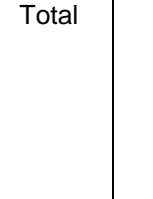
Figure – 240 ALBATROS (cont.)

Albatross 240d and 240e – An Albatross is executed until the *Half Twist* is completed. The designated *Spin* is executed as the bent leg is extended to meet the vertical leg.

Note: Refer to Section BM 13 Spins & Spin Allowances.

Figure – 240e ALBATROSS SPINNING 360°

DIFFICULTY – 2.0

						Total
NVT=	15.0	15.0	15.0	16.0	0	61
PV =	2.46	2.46	2.46	2.62	0	10

Albatross 240h and 240i – An Albatross is executed until the *Half Twist* is completed. Maintaining a **Bent Knee Vertical Position** the body descends to the ankle of the extended leg. The designated *Ascending Spin* is executed as the bent leg is extended to meet the vertical leg.

Note: Refer to Section BM 13 Spins & Spin Allowances.

Figure – 240h ALBATROSS SPIN UP 180°

DIFFICULTY – 2.4

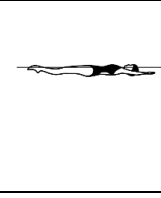
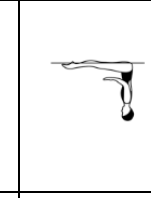
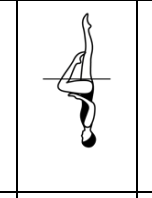
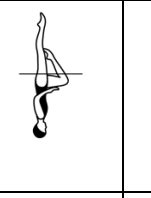
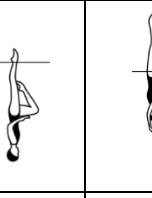
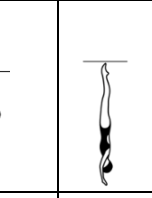
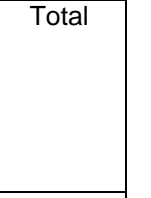
							Total
NVT=	15.0	15.0	15.0	10.0	17.5	14.0	86.5
PV =	1.73	1.73	1.73	1.16	2.02	1.62	10

Figure – 240i ALBATROSS SPIN UP 360°

DIFFICULTY – 2.5

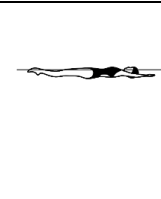
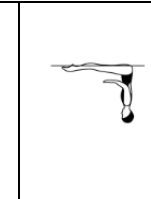
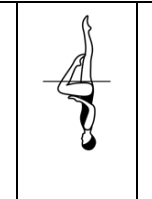
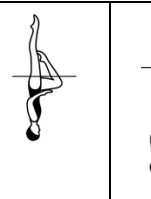
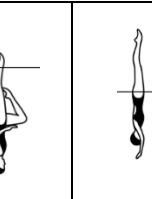
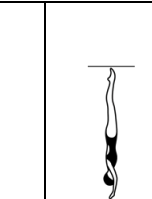
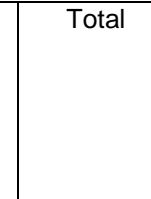







							Total
NVT=	15.0	15.0	15.0	10.0	18.5	14.0	87.5
PV =	1.71	1.71	1.71	1.14	2.11	1.60	10

Figure – 240 ALBATROSS (cont.)

Albatross 240j – An Albatross is executed until the *Half Twist* is completed. A *Combined Spin* is executed as the bent leg is extended to meet the vertical leg on the descent, and bends to resume a **Bent Knee Vertical Position** on the ascent. A *Vertical Descent* is executed in the **Bent Knee Vertical Position**.

Note: Refer to Section BM 13 Spins.

Figure – 240j ALBATROSS COMBINED SPIN (360° + 360°)* DIFFICULTY – 2.6

							Total
NVT=	15.0	15.0	15.0	40.0		10.0	95
PV =	1.58	1.58	1.58	4.21		1.05	10

***There is no Spin Allowance for Combined Spins.**

Figure – 241 GOELAND

DIFFICULTY – 2.0

From a **Back Layout Position** with the head leading, the head, hips and feet move along the surface of the water. The hips, legs and feet continue to move along the surface of the water as the body rolls onto the face and a *Front Pike Position* is assumed with the hips occupying the position of the head at the beginning of this action. One leg is lifted to vertical as the body rotates 90° on its longitudinal axis to assume a **Side Fishtail Position**. With continuous motion and in the same direction another 90° rotation is executed as the vertical leg lowers to assume a **Split Position**. A *Walkout Back* is executed.






					Total
NVT=	15.0	23.0	19.0	6.0	63
PV =	2.38	3.65	3.02	0.95	10

Figure Description	NVT	Diagrams	Major Desired Actions
--------------------	-----	----------	-----------------------

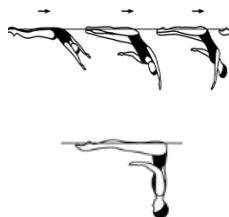
1. From a **Back Layout Position** with the head leading, the head, hips and feet move along the surface of the water.



1. See BP 1 **Back Layout Position** and BM 3 To Assume a *Front Pike Position*.

2. The hips, legs and feet continue to move along the surface of the water as the body rolls onto the face and a *Front Pike Position* is assumed with the hips occupying the position of the head at the beginning of this action.

15.0

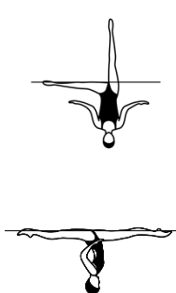
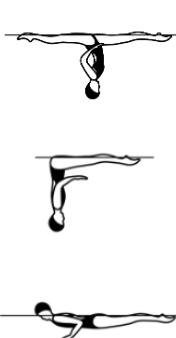


2.1 See BP 10 **Front Pike Position** and BM 3 To Assume a *Front Pike Position*.

The body roll, trunk descent and hip movement along the surface of the water occurs simultaneously, with the transition completed as the trunk becomes vertical and the hips replace the head at the surface of the water.
 2.2 The hips and head lock into the **Front Pike Position** simultaneously.

Figure – 241 GOELAND (cont.)

DIFFICULTY – 2.0

Figure Description	NVT	Diagrams	Major Desired Actions
<p>3. One leg is lifted to vertical as the body rotates 90° on its longitudinal axis to assume a Side Fishtail Position. With continuous motion and in the same direction another 90° rotation is executed as the vertical leg lowers to assume a Split Position.</p>	23.0		<p>3.1 Constant height and continuous motion as the body rotates simultaneously with the 180° leg arc over the surface of the water to BP 16a Surface Split Position.</p> <p>3.2 BP 19 Side Fishtail Position must be clearly evident. There is no pause in this position as the leg passes through the mid-point of the 180° arc.</p> <p>3.3 Vertical alignment of the trunk must be maintained throughout the rotation.</p>
<p>4. A <i>Walkout Back</i> is executed.</p>	19.0 6.0		<p>4. See BM 6b <i>Walkout Back</i>.</p>

BP 1 Back Layout Position



Body Position Description	Diagrams	Major Desired Actions
<p>1. Body extended with face, chest, thighs and feet at the surface of the water.</p>		<p>1. Gives the impression that the body is stretched horizontally to its maximum. Front of the trunk will also be at the surface of the water.</p>
<p>2. Head (ears specifically), hips and ankles in horizontal alignment.</p>		<p>2. Judgement is made by checking visual points of the horizontal alignment: ears, shoulder joints, hip joints and ankles. This imaginary line should also pass through the middle of the side of the trunk.</p>



Figure – 241 GOELAND (cont.)

DIFFICULTY – 2.0

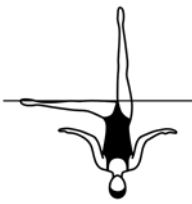
BP 10 Front Pike Position

Body Position Description	Diagrams	Major Desired Actions
1. Body bent at hips to form a 90° angle.		1. Exact 90° angle.
2. Legs extended and together.		2. Full extension of legs, with ankles aligned with hip joints.
3. Trunk extended with the back straight and head in line.		3. Back flat, with vertical alignment of ears, shoulder joints and hip joints once the position is established.


BP 16 Split Position

Body Position Description	Diagrams	Major Desired Actions
1. Legs evenly split forward and back. 2. The legs are parallel to the surface of the water. 3. Lower back arched, with hips, shoulders and head on a vertical line. 4. 180° angle between the extended legs (flat split), with inside of each leg aligned on opposite sides of a horizontal line, regardless of the height of the hips.		1. Full extension of the legs at or above the surface of the water. 4. Flat split. Hip joints and shoulder joints on a horizontal line, with both of these alignments 'square' and parallel to each other.
a) Surface Split Position 1. Legs are dry at the surface of the water.		1. Full extension of the legs. Crotch and legs dry at the surface of the water.

BP 19 Side Fishtail Position

Body Position Description	Diagrams	Major Desired Actions
1. Body extended in Vertical Position with one leg extended sideways with the foot at the surface of the water regardless of the height of the hips.		1. BP 6 Vertical Position alignment must be evident from a front or back view of the extended body. The head, trunk and extended leg face forward.

BP 2 Front Layout Position

Body Position Description	Diagrams	Major Desired Actions
1. Body extended with head, upper back, buttocks and heels at the surface of the water.		1. Gives the impression that the body is stretched horizontally to its maximum. Judgement made by checking visual points of the horizontal alignment: ears, shoulder joints, hip joints and heels.
2. Unless otherwise specified, face may be in or out of the water.		2. Once the head position is established as in or out of the water the position is maintained. When the face is out of the water the ears will not be on the horizontal axis and the back may be slightly lower and arched. Hip joints, calves and heels remain at the surface of the water.

BM 3 To Assume a Front Pike Position – adapted from Back Layout Position


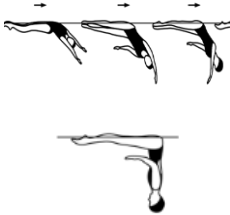

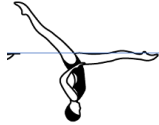




Basic Movement Description	NVT	Diagrams	Major Desired Actions
1. From a Back Layout Position with the head leading, the head, hips and feet move along the surface of the water.			1. See BP 1 Back Layout Position . Uniform motion in downward movement of the trunk. Continuous uniform movement from Back Layout Position .
2. The hips, legs and feet continue to move along the surface of the water as the body rolls onto the face and a <i>Front Pike Position</i> is assumed with the hips occupying the position of the head at the beginning of this action.	15.0		2. See BP 10 Front Pike Position and BM 3 <i>To Assume a Front Pike Position</i> . Uniform motion in downward movement of the trunk. The body turn, trunk descent and hip movement along the surface of the water occur simultaneously. The hips and head lock into the Front Pike Position simultaneously.

Figure – 241 GOELAND (cont.)

DIFFICULTY – 2.0

BM 6 Walkouts

Basic Movement Description	NVT	Diagrams	Major Desired Actions
<p>1. These movements start in a Split Position unless otherwise specified in the figure description. The hips remain stationary as one leg is lifted in an arc over the surface of the water to meet the opposite leg.</p>			<p>1. See BP 16a Surface Split Position.</p>
<p>b) Walkout Back</p> <p>3. The back leg is lifted in a 180° arc over the surface of the water to meet the opposite leg in a Front Pike Position and with continuous movement the body straightens to a Front Layout Position.</p>	<p>19.0</p>	 	<p>3.1 Hip height remains constant and at the surface of the water. 3.2 Arcing leg moves continuously with uniform motion. 3.3 Both legs maintain full extension. 3.4 The trunk remains stationary until the feet join. 3.5 An accurate BP 10 Front Pike Position should be evident before the body begins to straighten and rise.</p>
<p>4. The head surfaces at the position occupied by the hips at the beginning of this action.</p>	<p>6.0</p>	  	<p>See BP 10 Front Pike and BP 2 Front Layout Position.</p> <p>4. The body straightens, rises and moves along the surface simultaneously with a stationary BP 2 Front Layout Position achieved as the head surfaces.</p>



Artistic Swimming Figures Manual

2022 – 2025

Part 2

Category III a

CATEGORY III		
301	Barracuda	1.8
301c	Barracuda Twirl	2.5
301d	Barracuda Spinning 180°	2.0
301e	Barracuda Spinning 360°	2.3
301f	Barracuda Continuous Spin (720°)	2.8
301h	Barracuda Spin Up 180°	2.4
301i	Barracuda Spin Up 360°	2.4
302	Blossom	1.4
303	Somersault Back Pike	1.4
306	Barracuda Bent Knee	1.7
306d	Barracuda Bent Knee Spinning 180°	1.8
306e	Barracuda Bent Knee Spinning 360°	1.9
307	Flying Fish	2.4
307d	Flying Fish Spinning 180°	2.6
307e	Flying Fish Spinning 360°	2.9
308	Barracuda Airborne Split	2.3
308h	Barracuda Airborne Split Spin Up 180°	2.9
308i	Barracuda Airborne Split Spin Up 360°	3.0
310	Somersault Back Tuck	1.1
311	Kip	1.6
311a	Kip ½ Twist	2.0
311b	Kip Full Twist	2.2
311c	Kip Twirl	2.1
311d	Kip Spinning 180°	1.7
311e	Kip Spinning 360°	1.7

CATEGORY III		
CATEGORY III		
311f	Kip Continuous Spin (720°)	2.0
311g	Kip Twist Spin	2.2
311h	Kip Spin Up 180°	2.2
311i	Kip Spin Up 360°	2.3
311j	Kip Combined Spin (360°+360°)	2.4
312	Kip Split	2.3
313	Kip Split Closing 180°	2.2
314	Kip Split Open 360°	2.9
315	Seagull	2.2
315c	Seagull Twirl	2.7
315d	Seagull Spinning 180°	2.2
315e	Seagull Spinning 360°	2.3
315f	Seagull Continuous Spin (720°)	2.6
315h	Seagull Spin Up 180°	2.8
315i	Seagull Spin Up 360°	2.8
316	Kipnus	1.4
317	Kipnus Variant	1.9
318	Kip Bent Knee	1.8
319	Kipswirl	1.7
319c	Kipswirl Twirl	2.1
319d	Kipswirl Spinning 180°	1.7
319e	Kipswirl Spinning 360°	1.8
319f	Kipswirl Continuous Spin (720°)	2.0
320	Kipswirl Split Closing 180°	2.3

CATEGORY III		
321	Kipswirl Split Closing 360°	2.5
CATEGORY III		
322	Elevator	2.5
323	Somersault Front Pike	1.4
324	Somersub	1.9
325	Subalina	2.2
326	Subilarc	2.8
327	Ballerina	1.8
328	Lagoon	2.4
330	Aurora	2.3
330a	Aurora ½ Twist	2.7
330c	Aurora Twirl	2.8
330d	Aurora Spinning 180°	2.3
330e	Aurora Spinning 360°	2.4
330f	Aurora Continuous Spin (720°)	2.7
330g	Aurora Twist Spin	2.9
331	Aurora Open 180°	3.0
332	Aurora Open 360°	3.1
335	Gaviata	2.3
336	Gaviata Open 180°	2.4
342	Heron	1.9
342c	Heron Twirl	2.4
342d	Heron Spinning 180°	2.1
342e	Heron Spinning 360°	2.2
342f	Heron Continuous Spin (720°)	2.4

CATEGORY III		
342h	Heron Spin Up 180°	2.4
342i	Heron Spin Up 360°	2.4
CATEGORY III		
343	Butterfly	2.5
344	Neptunus	1.6
345	Catalina Reverse	2.1
346	Side Fishtail Split	2.0
347	Minerva	2.0
348	Tower	1.9
349	Beluga	2.1
350	Dalecarlia	2.6
351	Jupiter	2.8
352	Venus	3.0
355	Porpoise	1.8
355a	Porpoise ½ Twist	2.2
355b	Porpoise Full Twist	2.4
355c	Porpoise Twirl	2.3
355d	Porpoise Spinning 180°	1.9
355e	Porpoise Spinning 360°	1.9
355f	Porpoise Continuous Spin (720°)	2.2
355g	Porpoise Twist Spin	2.5
355h	Porpoise Spin Up 180°	2.5
355i	Porpoise Spin Up 360°	2.5
355j	Porpoise Combined Spin (360°+360°)	2.6
356	Whip	2.6

CATEGORY III		
356f	Whip Continuous Spin (720°)	3.0
359	Front Ariana	2.2
360	Walkover Front	1.9
	CATEGORY III	
361	Prawn	1.5
362	Surface Prawn	1.3
363	Water Drop	1.8
364	Whirlwind	2.7

Figure – 301 BARRACUDA

DIFFICULTY – 1.8

From a **Back Layout Position** the legs are raised to vertical as the body is submerged to a **Back Pike Position** with the toes just under the surface of the water. A *Thrust* is executed to **Vertical Position**. A *Vertical Descent* is executed at the same tempo as the *Thrust*.





				Total
NVT=	7.0	31.0	13.0	51
PV =	1.37	6.08	2.55	10

Figure Description	NVT	Diagrams	Major Desired Actions
--------------------	-----	----------	-----------------------

1. From a **Back Layout Position** the legs are raised to vertical as the body is submerged to a **Back Pike Position** with the toes just under the surface of the water.

7.0



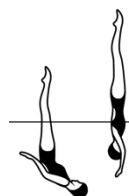
1.1 See BP 1 **Back Layout Position** and BP 11 **Back Pike Position**.

In the submerged **Back Pike Position** the hips are directly beneath the position they occupied in the **Back Layout Position**.

1.2 The pike is held only long enough to define the position and complete the transition.

2. A *Thrust* is executed to **Vertical Position**.

31.0



2.1 See BM 9 *Thrust*.

Obvious increase in speed.

2.2 The body unrolls under the legs to assume BP 6 **Vertical Position**.

2.3 Maximum height and clearly defined BP 6 **Vertical Position** prior to initiation of the descent.

3. A *Vertical Descent* is executed at the same tempo as the *Thrust*.

13.0




3. See BM 10 *Vertical Descent*. Must be rapid and remain on the same vertical line as the *Thrust*.


Figure – 301 BARRACUDA (cont.)

DIFFICULTY – 1.8

BP 1 Back Layout Position

Body Position Description	Diagrams	Major Desired Actions
<p>1. Body extended with face, chest, thighs and feet at the surface of the water.</p>		<p>1. Gives the impression that the body is stretched horizontally to its maximum. Front of the trunk will also be at the surface of the water.</p>
<p>2. Head (ears specifically), hips and ankles in horizontal alignment.</p>		<p>2. Judgement is made by checking visual points of the horizontal alignment: ears, shoulder joints, hip joints and ankles. This imaginary line should also pass through the middle of the side of the trunk.</p>

BP 11 Back Pike Position

Body Position Description	Diagrams	Major Desired Actions
<p>1. Body bent at hips to form an acute angle of 45° or less.</p>		<p>1. Legs close to chest while maintaining the straight line alignment of the extended spine and head.</p>
<p>2. Legs extended and together.</p>		<p>2. Full extension of the legs, ankles and feet.</p>
<p>3. Trunk extended with the back straight and head in line.</p>		<p>3. Back flat, with ears, shoulder joints, middle of side of torso, and hip joints aligned. Once the pike position is established the degree of the angle remains constant.</p>

BP 6 Vertical Position


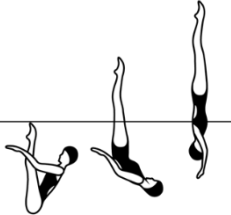
Body Position Description	Diagrams	Major Desired Actions
<p>1. Body extended perpendicular to the surface of the water; legs together, head downward.</p>		<p>1. Full extension of the body.</p>
<p>2. Head (ears specifically), hips and ankles in line.</p>		<p>2. Judgement is made by checking visual points of the vertical alignment: ears, shoulder joints, hip joints and ankles.</p>

Figure – 301 BARRACUDA (cont.)

DIFFICULTY – 1.8

BM 9 Thrust

Basic Movement Description	NVT	Diagrams	Major Desired Actions
<p>1. From a Submerged Back Pike Position with the legs perpendicular to the surface of the water a vertical upward movement of the legs and hips is rapidly executed as the body unrolls to assume a Vertical Position.</p>	31.0		<p>1.1 See BP 11 Back Pike Position. The toes are just below the surface of the water. Once established, the degree of the angle of the pike position between the legs and the body must not change prior to initiation of the <i>Thrust</i>.</p> <p>1.2 See BP 6 Vertical Position. The body unrolls rapidly under the legs to assume BP 6 Vertical Position along the same perpendicular line to the surface of the water established by the legs in the BP 11 Back Pike Position.</p> <p>1.3 Obvious increase in speed from the initiation of body unrolling through the vertical upward movement.</p>
<p>2. Maximum height desirable.</p>			<p>2. Maximum height and BP 6 Vertical Position achieved simultaneously.</p>

Thrust Allowance

Deviation allowances for the *Thrust* action are unique and allow for the legs to be up to an additional 15 degrees off the vertical line.

Deductions are as follows:

	Angle Deviation	Deduction Amount
Small Deviation	0 – 30 degrees	.2
Medium Deviation	31 – 45 degrees	.5
Large Deviation	46 degrees or more	1.0

BM 10 Vertical Descent – from Thrust

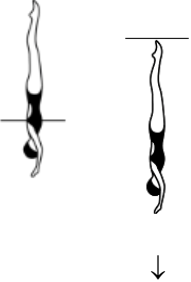
Basic Movement Description	NVT	Diagrams	Major Desired Actions
<p>1. Maintaining a Vertical Position the body descends along its longitudinal axis until the toes are submerged.</p>	13.0		<p>1. See BP 6 Vertical Position. The <i>Vertical Descent</i> is executed at the same tempo as the <i>Thrust</i>.</p>






Figure – 301 BARRACUDA (cont.)

Barracuda 301c – A Barracuda is executed to **Vertical Position**. A *Twirl* is executed. A *Vertical Descent* is executed at the same tempo as the *Thrust*.

Note: Refer to Section BM 12 Twists & Twist Allowances.

Figure – 301c BARRACUDA TWIRL

DIFFICULTY – 2.5

					Total
NVT=	7.0	31.0	40.0	13.0	91
PV =	0.77	3.41	4.40	1.43	10

Barracuda 301d and 301e – A Barracuda is executed to **Vertical Position**. The designated *Spin* is executed at the same tempo as the *Thrust*.

Note: Refer to Section BM 13 Spins & Spin Allowances.

Figure – 301d BARRACUDA SPINNING 180°

DIFFICULTY – 2.0











					Total
NVT=	7.0	31.0	24.0	0	62
PV =	1.13	5.00	3.87	0	10

Figure – 301 BARRACUDA (cont.)

Barracuda 301d and 301e – A Barracuda is executed to **Vertical Position**. The designated *Spin* is executed at the same tempo as the *Thrust*.

Note: Refer to Section BM 13 Spins & Spin Allowances.

Figure – 301e BARRACUDA SPINNING 360°
DIFFICULTY – 2.3

						Total
NVT=	7.0	31.0	39.0	0	0	77
PV =	0.91	4.03	5.06	0	0	10

Barracuda 301f – A Barracuda is executed to **Vertical Position**. A *Continuous Spin* is executed at the same tempo as the *Thrust*.

Note: Refer to Section BM 13 Spins & Spin Allowances.

Figure – 301f BARRACUDA CONTINUOUS SPIN (720°)
DIFFICULTY – 2.8





					Total
NVT=	7.0	31.0	67.0	0	105
PV =	0.67	2.95	6.38	0	10

Figure – 301 BARRACUDA (cont.)

Barracuda 301h and 301i – A Barracuda is executed to **Vertical Position**. A *Vertical Descent* is executed at the same tempo as the *Thrust* to ankle level. The designated *ascending Spin* is executed. A *Vertical Descent* is executed at the same tempo as the *Thrust*.

****ascending Spin:** The *ascending Spin* should NOT be performed rapidly but should be performed as the body rises and rotates simultaneously, evenly and at the same tempo as the root figure **Back Layout Position** to **Back Pike Position**.

Note: Refer to Section BM 13 Spins & Spin Allowances.

Figure – 301h BARRACUDA SPIN UP 180°
DIFFICULTY – 2.4




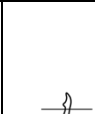
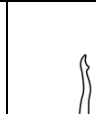
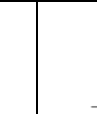
							Total
NVT=		7.0	31.0	13.0	20.0	13.0	84
PV =		0.83	3.69	1.55	2.38	1.55	10

Figure – 301i BARRACUDA SPIN UP 360°
DIFFICULTY – 2.4






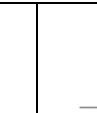
							Total
NVT=		7.0	31.0	13.0	21.0	13.0	85
PV =		0.82	3.65	1.53	2.47	1.53	10

Figure – 302 BLOSSOM

DIFFICULTY – 1.4

From a **Back Layout Position** the trunk is lowered as the hips are bent to assume a **Submerged Ballet Leg Double Position**. The feet separate along the surface of the water as the hips rise and the body assumes a **Split Position**. The legs join to assume a **Vertical Position** at ankle level. A *Vertical Descent* is executed.






					Total
NVT=	10.0	11.0	5.0	5.0	31
PV =	3.23	3.55	1.61	1.61	10


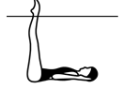




Figure Description	NVT	Diagrams	Major Desired Actions
<p>1. From a Back Layout Position the trunk is lowered as the hips are bent to assume a Submerged Ballet Leg Double Position.</p>	10.0	 	<p>1.1 See BP 1 Back Layout and BP 5b Submerged Ballet Leg Double Position. The hips are directly beneath the position they occupied in the Back Layout Position.</p> <p>1.2 The legs are vertical with a 90° angle between the legs and the trunk. The trunk remains parallel to the surface of the water as it lowers.</p>
<p>2. The feet separate along the surface of the water as the hips rise and the body assumes a Split Position.</p>	11.0		<p>2. See BP 16a Surface Split Position. The hips rise along a vertical line as the body moves into vertical alignment beneath the hips.</p>
<p>3. The legs join to assume a Vertical Position at ankle level.</p>	5.0		<p>3. See BP 6 Vertical Position. The establishment of the water level at the ankles and the Vertical Position are achieved simultaneously.</p>

Figure – 302 BLOSSOM (cont.)

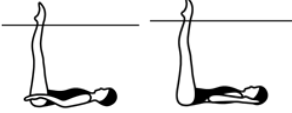
DIFFICULTY – 1.4

Figure Description	NVT	Diagrams	Major Desired Actions
4. A <i>Vertical Descent</i> is executed	5.0		4.1 See BM 10 <i>Vertical Descent</i> .

BP 1 Back Layout Position

Body Position Description	Diagrams	Major Desired Actions
1. Body extended with face, chest, thighs and feet at the surface of the water.		1. Gives the impression that the body is stretched horizontally to its maximum. Front of the trunk will also be at the surface of the water.
2. Head (ears specifically), hips and ankles in horizontal alignment.		2. Judgement is made by checking visual points of the horizontal alignment: ears, shoulder joints, hip joints and ankles. This imaginary line should also pass through the middle of the side of the trunk.

BP 5 Ballet Leg Double Position

Body Position Description	Diagrams	Major Desired Actions
b) Submerged		
1. Trunk and head parallel to the surface of the water.		1. Ears, shoulder joints and hip joints aligned.
2. 90° angle between the trunk and the extended legs.		2. Legs perpendicular to the surface of the water. Body extended horizontally at 90° angle to the surface of the water.
3. Water level between knees and ankles of the extended legs.		



BP 16 Split Position

Body Position Description	Diagrams	Major Desired Actions
1. Legs evenly split forward and back.		1. Full extension of the legs at or above the surface of the water.
2. The legs are parallel to the surface of the water.		
3. Lower back arched, with hips, shoulders and head on a vertical line.		


Figure – 302 BLOSSOM (cont.)

DIFFICULTY – 1.4

BP 16 Split Position (cont.)

Body Position Description	Diagrams	Major Desired Actions
<p>4. 180° angle between the extended legs (flat split), with inside of each leg aligned on opposite sides of a horizontal line, regardless of the height of the hips.</p>		<p>4. Flat split. Hip joints and shoulder joints on a horizontal line, with both of these alignments 'square' and parallel to each other.</p>
<p>a) Surface Split Position 1. Legs are dry at the surface of the water.</p>		<p>1. Full extension of the legs. Crotch and legs dry at the surface of the water.</p>

BP 6 Vertical Position – ankle level

Body Position Description	Diagrams	Major Desired Actions
<p>1. Body extended perpendicular to the surface of the water; legs together, head downward.</p> <p>2. Head (ears specifically), hips and ankles in line.</p>		<p>1. Full extension of the body.</p> <p>2. Judgement made by checking visual points of the vertical alignment: ears, shoulder joints, hip joints and ankles.</p>

BM 10 Vertical Descent – from ankle level

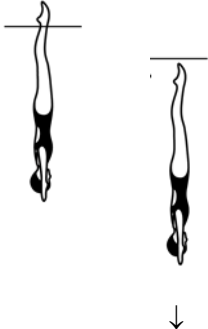
Basic Movement Description	NVT	Diagrams	Major Desired Actions
<p>1. Maintaining a Vertical Position the body descends along its longitudinal axis until the toes are submerged.</p>	<p>5.0</p>		<p>1. See BP 6 Vertical Position. The tempo of the descent is uniform and at the same speed as the rest of the figure.</p>

Figure – 303 SOMERSAULT BACK PIKE
DIFFICULTY – 1.4

From a **Back Layout Position** with the trunk remaining parallel and close to the surface of the water, the legs are raised rapidly to assume a **Back Pike Position**. Without a pause the body somersaults backwards around a lateral axis until the feet and head simultaneously reach the surface of the water. A **Back Layout Position** is assumed.





				Total
NVT=	14.0	13.0	5.0	32
PV =	4.38	4.06	1.56	10

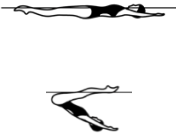
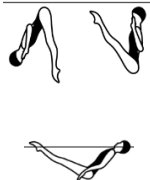


Figure Description	NVT	Diagrams	Major Desired Actions
1. From a Back Layout Position with the trunk remaining parallel and close to the surface of the water, the legs are raised rapidly to assume a Back Pike Position .	14.0		1. See BP 1 Back Layout and BP 11 Back Pike Positions . The Back Pike Position is achieved with the legs at a diagonal to the surface of the water.
2. Without a pause the body somersaults around a lateral axis until the feet and head simultaneously reach the surface of the water.	13.0		2.1 There is no pause between the achievement of the Back Pike Position and the initiation of the rotation. The size of the pike angle remains constant throughout. 2.2 The somersault rotation is established just under the surface of the water as soon as the legs are raised to assume a Back Pike Position and is maintained throughout. 2.3 The hips remain stationary as the legs are raised and as the body pivots around the hips. 2.4 The tempo of the rotation is uniform but not rapid.
3. A Back Layout Position is assumed.	5.0		3. Hips ascend vertically, finishing in the same location as in the original Back Layout Position . Height and full extension achieved simultaneously.

Figure – 303 SOMERSAULT BACK PIKE (cont.)
DIFFICULTY – 1.4
BP 1 Back Layout Position

Body Position Description	Diagrams	Major Desired Actions
1. Body extended with face, chest, thighs and feet at the surface of the water.		1. Gives the impression that the body is stretched horizontally to its maximum. Front of the trunk will also be at the surface of the water.
2. Head (ears specifically), hips and ankles in horizontal alignment.		2. Judgement is made by checking visual points of the horizontal alignment: ears, shoulder joints, hip joints and ankles. This imaginary line should also pass through the middle of the side of the trunk.

BP 11 Back Pike Position



Body Position Description	Diagrams	Major Desired Actions
1. Body bent at hips to form an acute angle of 45° or less.		1. Legs close to chest while maintaining the straight line alignment of the extended spine and head.
2. Legs extended and together.		2. Full extension of the legs, ankles and feet.
3. Trunk extended with the back straight and head in line.		3. Back flat, with ears, shoulder joints, middle of side of torso, and hip joints aligned. Once the pike position is established the degree of the angle remains constant.

Figure – 306 BARRACUDA BENT KNEE
DIFFICULTY – 1.7

From a **Back Layout Position** the legs are raised to vertical as the body is submerged to a **Back Pike Position** with the toes just below the surface of the water. A *Thrust* is executed as one foot is drawn along the inside of the extended leg to assume a **Bent Knee Vertical Position**. A *Vertical Descent* is executed in a **Bent Knee Vertical Position** at the same tempo as the *Thrust*.





				Total
NVT=	7.0	28.0	9.0	44
PV =	1.59	6.36	2.05	10

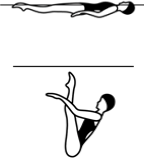



Figure Description	NVT	Diagrams	Major Desired Actions
1. From a Back Layout Position the legs are raised to vertical as the body is submerged to a Back Pike Position with the toes just below the surface of the water.	7.0		1.1 See BP 1 Back Layout and BP 11 Back Pike Positions . In the submerged Back Pike Position the hips are directly beneath the position they occupied in the Back Layout Position . 1.2 The pike position is held only long enough to define the position and complete the transition.
2. A <i>Thrust</i> is executed as one foot is drawn along the inside of the extended leg to assume a Bent Knee Vertical Position .	28.0		2.1 See BM 9 <i>Thrust</i> . Obvious increase in speed. 2.2 Maximum height achieved simultaneously with assuming a BP 14c Bent Knee Vertical Position which must be clearly defined prior to initiation of descent.
3. A <i>Vertical Descent</i> is executed in a Bent Knee Vertical Position at the same tempo as the <i>Thrust</i> .	9.0		3. See BP 14c Bent Knee Vertical Position and See BM 10 <i>Vertical Descent</i> . Must be rapid and remain on the same vertical line as the <i>Thrust</i> .


Figure – 306 BARRACUDA BENT KNEE (cont.)

DIFFICULTY – 1.7

BP 1 Back Layout Position

Body Position Description	Diagrams	Major Desired Actions
<p>1. Body extended with face, chest, thighs and feet at the surface of the water.</p> <p>2. Head (ears specifically), hips and ankles in horizontal alignment.</p>		<p>1. Gives the impression that the body is stretched horizontally to its maximum. Front of the trunk will also be at the surface of the water.</p> <p>2. Judgement is made by checking visual points of the horizontal alignment: ears, shoulder joints, hip joints and ankles. This imaginary line should also pass through the middle of the side of the trunk.</p>

BP 11 Back Pike Position

Body Position Description	Diagrams	Major Desired Actions
<p>1. Body bent at hips to form an acute angle of 45° or less.</p> <p>2. Legs extended and together.</p> <p>3. Trunk extended with the back straight and head in line.</p>		<p>1. Legs close to chest while maintaining the straight line alignment of the extended spine and head.</p> <p>2. Full extension of the legs, ankles and feet.</p> <p>3. Back flat, with ears, shoulder joints, middle of side of torso, and hip joints aligned. Once the pike position is established the degree of the angle remains constant.</p>

BP 14 Bent Knee Position

Body Position Description	Diagrams	Major Desired Actions
<p>One leg bent with the toe of the bent leg in contact with the inside of the extended leg at the knee or higher.</p>		<p>The relationship of the toe of the bent leg to the extended leg may vary depending on the figure but should remain constant once established, and not extend in front of or behind the extended leg.</p>

Figure – 306 BARRACUDA BENT KNEE (cont.)

DIFFICULTY – 1.7

BP 14 Bent Knee Position (cont.)

Body Position Description	Diagrams	Major Desired Actions
---------------------------	----------	-----------------------

c) Bent Knee Vertical Position

1. Body extended in **Vertical Position** with the thigh of the bent leg parallel to the surface of the water.



1. In BP 6 **Vertical Position** the alignment of the extended leg, trunk and head remains constant.

BM 9 Thrust – adapted for Barracuda Bent Knee

Basic Movement Description	NVT	Diagrams	Major Desired Actions
----------------------------	-----	----------	-----------------------

From a Submerged **Back Pike Position**, with the legs perpendicular to the surface of the water, a vertical upward movement of the legs and hips is rapidly executed as the body unrolls and one foot is drawn along the inside of the extended leg to assume a **Bent Knee Vertical Position**.

28.0



1.1 See BP 11 **Back Pike Position**. The toes are just below the surface of the water. Once established, the degree of the angle of the pike position between the legs and the body must not change prior to initiation of the *Thrust*.

1.2 See BP 14c **Bent Knee Vertical Position**. The body unrolls under the legs to assume a **Bent Knee Vertical Position** along the same perpendicular line to the surface of the water established by the legs in the BP 11 **Back Pike Position**.

1.3 The toes of the bent leg remain in contact with the extended leg throughout the unroll.

1.4 Obvious increase in speed of action must be evident.

2. Maximum height desirable.

2. Maximum height and BP 14c **Bent Knee Vertical Position** achieved simultaneously.



Figure – 306 BARRACUDA BENT KNEE (cont.)
DIFFICULTY – 1.7
Thrust Allowance

Deviation allowances for the *Thrust* action are unique and allow for the legs to be up to an additional 15 degrees off the vertical line.

Deductions are as follows:

	Angle Deviation	Deduction Amount
Small Deviation	0 – 30 degrees	.2
Medium Deviation	31 – 45 degrees	.5
Large Deviation	46 degrees or more	1.0

BM 10 Vertical Descent in Bent Knee Vertical Position

Basic Movement Description	NVT	Diagrams	Major Desired Actions
<p>1. Maintaining a Bent Knee Vertical Position, the body descends along its longitudinal axis until the toes are submerged.</p>	9.0	 	<p>1. See BP 14c Bent Knee Vertical Position.</p> <p>2. The descent is executed at the same tempo as the <i>Thrust</i>.</p>

Barracuda 306d and 306e – A Barracuda Bent Knee is executed to a **Bent Knee Vertical Position**. The designated *Spin* is executed as the bent knee is extended to meet the vertical leg at the same tempo as the *Thrust*.

Note: Refer to Section BM 13 Spins & Spin Allowances.

Figure – 306d BARRACUDA BENT KNEE SPINNING 180°
DIFFICULTY – 1.8






					Total
NVT=	7.0	28.0	18.0	0	53
PV =	1.32	5.28	3.40	0	10

Figure – 306 BARRACUDA BENT KNEE (cont.)

Barracuda 306d and 306e – A Barracuda Bent Knee is executed to a **Bent Knee Vertical Position**. The designated *Spin* is executed as the bent knee is extended to meet the vertical leg at the same tempo as the *Thrust*.

Note: Refer to Section BM 13 Spins & Spin Allowances.

Figure – 306e BARRACUDA BENT KNEE SPINNING 360° DIFFICULTY – 1.9






					Total
NVT=	7.0	28.0	24.0	0	59
PV =	1.19	4.75	4.07	0	10

Figure – 307 FLYING FISH

DIFFICULTY – 2.4

From a **Back Layout Position** the legs are raised to vertical as the body is submerged to a **Back Pike Position** with the toes just below the surface of the water. A *Thrust* is executed to a **Vertical Position** and with no loss of height one leg is rapidly lowered to a **Fishtail Position**, and without a pause the horizontal leg is rapidly lifted to a **Vertical Position**. A *Vertical Descent* is executed at the same tempo as the *Thrust*.







						Total
NVT=	7.0	31.0	18.5	14.0	13.0	83.5
PV =	0.84	3.71	2.22	1.68	1.56	10




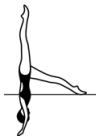

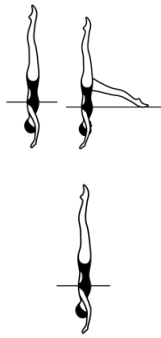


Figure Description	NVT	Diagrams	Major Desired Actions
<p>1. From a Back Layout Position the legs are raised to vertical as the body is submerged to a Back Pike Position with the toes just below the surface of the water.</p>	7.0	 	<p>1.1 See BP 1 Back Layout and BP 11 Back Pike Positions. In the submerged Back Pike Position, the hips are directly beneath the position they occupied in the Back Layout Position.</p> <p>1.2 The pike is held only long enough to define the position and complete the transition.</p>
<p>2. A <i>Thrust</i> is executed to a Vertical Position and with no loss of height one leg is rapidly lowered to a Fishtail Position, and without a pause the horizontal leg is rapidly lifted to a Vertical Position.</p>	31.0		<p>2.1 See BP 6 Vertical Position and BP 8 Fishtail Positions. Rapid speed evident from the BM 9 <i>Thrust</i> until completion of the figure.</p>
	18.5		<p>2.2 Stability in BP 6 Vertical Position evident prior to the lowering of the leg to BP 8 airborne Fishtail Position and prior to the descent.</p>
	14.0		<p>2.3 From the BP 6 Vertical Position to the BP 8 airborne Fishtail Position the trunk and vertical leg maintain vertical alignment.</p>

Figure – 307 FLYING FISH (cont.)
DIFFICULTY – 2.4

Figure Description	NVT	Diagrams	Major Desired Actions
2. (cont.) A <i>Thrust</i> is executed to a Vertical Position and with no loss of height one leg is rapidly lowered to a Fishtail Position , and without a pause the horizontal leg is rapidly lifted to a Vertical Position .	31.0 18.5 14.0		2.4 In BP 8 Fishtail Position , one foot must be at the surface of the water regardless of the height of the hips. The hip joints must be on a horizontal line.
3. A <i>Vertical Descent</i> is executed at the same tempo as the <i>Thrust</i> .	13.0		3. See BM 10 <i>Vertical Descent</i> . Must be rapid and remain on the same vertical line as the <i>Thrust</i> . The <i>Vertical Descent</i> is executed at the same tempo as the <i>Thrust</i> .

BP 1 Back Layout Position

Body Position Description	Diagrams	Major Desired Actions
1. Body extended with face, chest, thighs and feet at the surface of the water.		1. Gives the impression that the body is stretched horizontally to its maximum. Front of the trunk will also be at the surface of the water.
2. Head (ears specifically), hips and ankles in horizontal alignment.		2. Judgement is made by checking visual points of the horizontal alignment: ears, shoulder joints, hip joints and ankles. This imaginary line should also pass through the middle of the side of the trunk.

BP 11 Back Pike Position



Body Position Description	Diagrams	Major Desired Actions
1. Body bent at hips to form an acute angle of 45° or less.		1. Legs close to chest while maintaining the straight line alignment of the extended spine and head.
2. Legs extended and together.		2. Full extension of the legs, ankles and feet.

Figure – 307 FLYING FISH (cont.)
DIFFICULTY – 2.4
BP 11 Back Pike Position (cont.)

Body Position Description	Diagrams	Major Desired Actions
3. Trunk extended with the back straight and head in line.		3. Back flat, with ears, shoulder joints, middle of side of torso, and hip joints aligned. Once the pike position is established the degree of the angle remains constant.

BP 6 Vertical Position

Body Position Description	Diagrams	Major Desired Actions
1. Body extended perpendicular to the surface of the water; legs together, head downward.		1. Full extension of the body.
2. Head (ears specifically), hips and ankles in line.		2. Judgement is made by checking visual points of the vertical alignment: ears, shoulder joints, hip joints and ankles.

BP 8 Fishtail Position


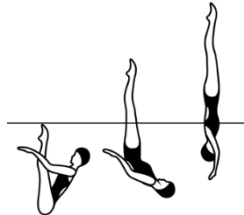
Body Position Description	Diagrams	Major Desired Actions
1. Body extended in Vertical Position with one leg extended forward. The foot of the forward leg is at the surface of the water regardless of the height of the hips.		1. See BP 6 Vertical Position for body alignment. The foot of the forward leg must be at the surface of the water. Hip joints must be on a horizontal line.

Figure – 307 FLYING FISH (cont.)

DIFFICULTY – 2.4

BM 9 Thrust

Basic Movement Description	NVT	Diagrams	Major Desired Actions
<p>1. From a Submerged Back Pike Position with the legs perpendicular to the surface of the water a vertical upward movement of the legs and hips is rapidly executed as the body unrolls to assume a Vertical Position.</p>	31.0		<p>1.1 See BP 11 Back Pike Position. The toes are just below the surface of the water. Once established, the degree of the angle of the pike position between the legs and the body must not change prior to initiation of the <i>Thrust</i>.</p> <p>1.2 See BP 6 Vertical Position. The body unrolls rapidly under the legs to assume BP 6 Vertical Position along the same perpendicular line to the surface of the water established by the legs in the BP 11 Back Pike Position.</p> <p>1.3 Obvious increase in speed from the initiation of body unrolling through the vertical upward movement.</p>
<p>2. Maximum height desirable.</p>			<p>2. Maximum height and BP 6 Vertical Position achieved simultaneously.</p>

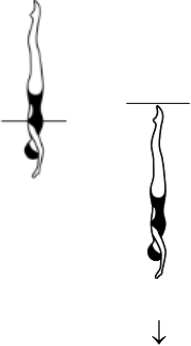
Thrust Allowance

Deviation allowances for the *Thrust* action are unique and allow for the legs to be up to an additional 15 degrees off the vertical line.

Deductions are as follows:

	Angle Deviation	Deduction Amount
Small Deviation	0 – 30 degrees	.2
Medium Deviation	31 – 45 degrees	.5
Large Deviation	46 degrees or more	1.0

Figure – 307 FLYING FISH (cont.)
DIFFICULTY – 2.4
BM 10 Vertical Descent – from Thrust

Basic Movement Description	NVT	Diagrams	Major Desired Actions
1. Maintaining a Vertical Position the body descends along its longitudinal axis until the toes are submerged.	13.0		1. See BP 6 Vertical Position . The <i>Vertical Descent</i> is executed at the same tempo as the <i>Thrust</i> .

Flying Fish 307d and 307e – A Flying Fish is executed to a **Vertical Position**. The designated *Spin* is executed at the same tempo as the *Thrust*.

Note: Refer to Section BM 13 Spins & Spin Allowances.

Figure – 307d FLYING FISH SPINNING 180°
DIFFICULTY – 2.6








							Total
NVT=	7.0	31.0	18.5	14.0	24.0	0	94.5
PV =	0.74	3.28	1.96	1.48	2.54	0	10

Figure – 307e FLYING FISH SPINNING 360°
DIFFICULTY – 2.9








							Total
NVT=	7.0	31.0	18.5	14.0	39.0	0	109.5
PV =	0.64	2.83	1.69	1.28	3.56	0	10

Figure – 308 BARRACUDA AIRBORNE SPLIT

DIFFICULTY – 2.3

From a **Back Layout Position** the legs are raised to vertical as the body is submerged to a **Back Pike Position** with the toes just under the surface of the water. A *Rocket Split* is executed.




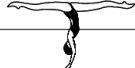


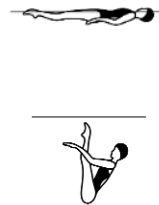
						Total
NVT=	7.0	31.0	17.0	13.0	13.0	81
PV =	0.86	3.83	2.10	1.60	1.60	10

Figure Description	NVT	Diagrams	Major Desired Actions
--------------------	-----	----------	-----------------------

1. From a **Back Layout Position** the legs are raised to vertical as the body is submerged to a **Back Pike Position** with the toes just under the surface of the water.

7.0

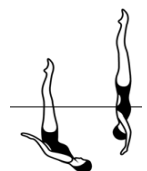


1.1 See BP 1 **Back Layout Position** and BP 11 **Back Pike Position**. In the submerged **Back Pike Position** the hips are directly beneath the position they occupied in the **Back Layout Position**.

1.2 The pike is held only long enough to define the position and complete the transition.

2. A *Rocket Split* is executed.

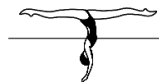
31.0



2.1 See BM 9 *Thrust* and BM 11 *Rocket Split*.

Rapid speed evident from the BM 9 *Thrust* until completion of the figure 2.2 Maximum height and BP 6 **Vertical Position** achieved simultaneously.

17.0



2.3 See BP 16 **Split Position** and BP 16b **Airborne Split Position**.

13.0



Full extension of the legs split evenly and completely above and parallel to the surface of the water followed by a rejoin to **Vertical Position**.

13.0




2.4. BP 6 **Vertical Position** evident prior to descent.

2.5. See BM 10 *Vertical Descent*. Must be rapid and remain on the same vertical line as the *Thrust*.


Figure – 308 BARRACUDA AIRBORNE SPLIT (cont.)

DIFFICULTY – 2.3

BP 1 Back Layout Position

Body Position Description	Diagrams	Major Desired Actions
<p>1. Body extended with face, chest, thighs and feet at the surface of the water.</p>		<p>1. Gives the impression that the body is stretched horizontally to its maximum. Front of the trunk will also be at the surface of the water.</p>
<p>2. Head (ears specifically), hips and ankles in horizontal alignment.</p>		<p>2. Judgement is made by checking visual points of the horizontal alignment: ears, shoulder joints, hip joints and ankles. This imaginary line should also pass through the middle of the side of the trunk.</p>

BP 11 Back Pike Position

Body Position Description	Diagrams	Major Desired Actions
<p>1. Body bent at hips to form an acute angle of 45° or less.</p>		<p>1. Legs close to chest while maintaining the straight line alignment of the extended spine and head.</p>
<p>2. Legs extended and together.</p>		<p>2. Full extension of the legs, ankles and feet.</p>
<p>3. Trunk extended with the back straight and head in line.</p>		<p>3. Back flat, with ears, shoulder joints, middle of side of torso, and hip joints aligned. Once the pike position is established the degree of the angle remains constant.</p>

BP 6 Vertical Position



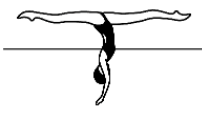
Body Position Description	Diagrams	Major Desired Actions
<p>1. Body extended perpendicular to the surface of the water; legs together, head downward.</p>		<p>1. Full extension of the body.</p>
<p>2. Head (ears specifically), hips and ankles in line.</p>		<p>2. Judgement is made by checking visual points of the vertical alignment: ears, shoulder joints, hip joints and ankles.</p>

Figure – 308 BARRACUDA AIRBORNE SPLIT (cont.)

DIFFICULTY – 2.3

BP 16 Split Position

Body Position Description	Diagrams	Major Desired Actions
<p>1. Legs evenly split forward and back.</p> <p>2. The legs are parallel to the surface of the water.</p> <p>3. Lower back arched, with hips, shoulders and head on a vertical line.</p> <p>4. 180° angle between the extended legs (flat split), with inside of each leg aligned on opposite sides of a horizontal line, regardless of the height of the hips.</p>		<p>1. Full extension of the legs at or above the surface of the water.</p> <p>4. Flat split. Hip joints and shoulder joints on a horizontal line, with both of these alignments 'square' and parallel to each other.</p>
<p>b) Airborne Split Position</p> <p>1. Legs are above the surface of the water.</p>		<p>1.1 Full extension of the legs completely above the surface of the water. Maximum height is desirable.</p> <p>1.2 Both legs equidistant from the surface of the water.</p>

BM 9 Thrust

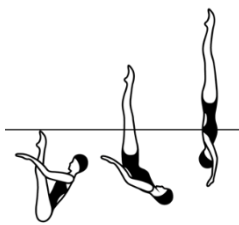
Basic Movement Description	NVT	Diagrams	Major Desired Actions
<p>1. From a Submerged Back Pike Position with the legs perpendicular to the surface of the water a vertical upward movement of the legs and hips is rapidly executed as the body unrolls to assume a Vertical Position.</p>	<p>31.0</p>		<p>1.1 See BP 11 Back Pike Position. The toes are just below the surface of the water. Once established, the degree of the angle of the pike position between the legs and the body must not change prior to initiation of the <i>Thrust</i>.</p> <p>1.2 See BP 6 Vertical Position. The body unrolls rapidly under the legs to assume BP 6 Vertical Position along the same perpendicular line to the surface of the water established by the legs in the BP 11 Back Pike Position.</p> <p>1.3 Obvious increase in speed from the initiation of body unrolling through the vertical upward movement.</p>

Figure – 308 BARRACUDA AIRBORNE SPLIT (cont.)
DIFFICULTY – 2.3
BM 9 Thrust (cont.)

Basic Movement Description	NVT	Diagrams	Major Desired Actions
2. Maximum height desirable.			2. Maximum height and BP 6 Vertical Position achieved simultaneously.



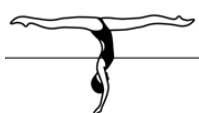


Thrust Allowance

Deviation allowances for the *Thrust* action are unique and allow for the legs to be up to an additional 15 degrees off the vertical line.

Deductions are as follows:

	Angle Deviation	Deduction Amount
Small Deviation	0 – 30 degrees	.2
Medium Deviation	31 – 45 degrees	.5
Large Deviation	46 degrees or more	1.0

Figure – 308 BARRACUDA AIRBORNE SPLIT (cont.)
DIFFICULTY – 2.3
BM 11 Rocket Split

Basic Movement Description	NVT	Diagrams	Major Desired Actions
1. A <i>Thrust</i> is executed to a Vertical Position . Maintaining maximum height the legs are split simultaneously and rapidly to assume an Airborne Split Position and rejoin to a Vertical Position , followed by a <i>Vertical Descent</i> .	31.0	 	1.1 See BM 9 <i>Thrust</i> (steps 1.1 to 2), BP 11 Back Pike Position , BP 6 Vertical Position , BP 16b Airborne Split Position . 1.2 The toes are just below the surface of the water. 1.3 Full extension of the legs above and parallel to the surface of the water. 1.4 The legs split evenly and rejoin in the same vertical line. No travel permitted.
	17.0		
	13.0		
2. The <i>Vertical Descent</i> is executed at the same tempo as the <i>Thrust</i> .	13.0		2. See BM 10 <i>Vertical Descent</i> .

BM 10 Vertical Descent – from Thrust



Basic Movement Description	NVT	Diagrams	Major Desired Actions
1. Maintaining a Vertical Position the body descends along its longitudinal axis until the toes are submerged.	13.0	 	1. See BP 6 Vertical Position . The <i>Vertical Descent</i> is executed at the same tempo as the <i>Thrust</i> .

Figure – 308 BARRACUDA AIRBORNE SPLIT (cont.)

Barracuda 308h and 308i – A Barracuda Airborne Split is executed to a rejoined **Vertical Position**. A *Vertical Descent* is executed at the same tempo as the *Thrust* completed as the ankles reach the surface of the water. A rapid designated *ascending Spin* is executed followed by a rapid *Vertical Descent*.

Note: Refer to Section BM 13 Spins & Spin Allowances.

Figure – 308h BARRACUDA AIRBORNE SPLIT SPIN UP 180° DIFFICULTY – 2.9









								Total
NVT=	7.0	31.0	17.0	13.0	13.0	20.0	13.0	114
PV =	0.61	2.72	1.49	1.14	1.14	1.75	1.14	10

Figure – 308i BARRACUDA AIRBORNE SPLIT SPIN UP 360° DIFFICULTY – 3.0









								Total
NVT=	7.0	31.0	17.0	13.0	13.0	21.0	13.0	115
PV =	0.61	2.70	1.48	1.13	1.13	1.83	1.13	10

Figure – 310 SOMERSAULT BACK TUCK
DIFFICULTY – 1.1

From a **Back Layout Position** the knees, shins and toes are drawn along the surface of the water to assume a **Tuck Position**. With continuous motion the tuck becomes more compact as the body somersaults backward around a lateral axis for one complete revolution. A **Back Layout Position** is resumed.





				Total
NVT=	3.0	5.0	3.0	11
PV =	2.73	4.55	2.73	10

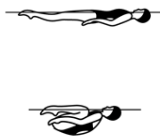



Figure Description	NVT	Diagrams	Major Desired Actions
<p>1. From a Back Layout Position the knees, shins and toes are drawn along the surface of the water to assume a Tuck Position.</p>	3.0		<p>1.1 See BP 1 Back Layout Position and BP 9 Tuck Position. With the head and shoulders remaining stationary, the knees, shins and toes are drawn to the body to assume a tight tuck at the position occupied by the trunk in the Back Layout Position.</p> <p>1.2 There is continuous motion from the initiation of the leg draw to achievement of the Tuck Position.</p>
<p>2. With continuous motion the tuck becomes more compact as the body somersaults backward around a lateral axis for one complete revolution.</p>	5.0		<p>2. The head becomes part of the compact tuck as the roll is initiated. Constant height is maintained during the rotation.</p>
<p>3. A Back Layout Position is resumed.</p>	3.0		<p>3.1 With the head and shoulders remaining stationary, the knees, shins and toes travel along the surface of the water and reach full extension as the body assumes a Back Layout Position.</p> <p>3.2 The finishing Back Layout Position should be in the same location as the starting Back Layout Position.</p>

Figure – 310 SOMERSAULT BACK TUCK (cont.)
DIFFICULTY – 1.1
BP 1 Back Layout Position

Body Position Description	Diagrams	Major Desired Actions
1. Body extended with face, chest, thighs and feet at the surface of the water.		1. Gives the impression that the body is stretched horizontally to its maximum. Front of the trunk will also be at the surface of the water.
2. Head (ears specifically), hips and ankles in horizontal alignment.		2. Judgement is made by checking visual points of the horizontal alignment: ears, shoulder joints, hip joints and ankles. This imaginary line should also pass through the middle of the side of the trunk.

BP 9 Tuck Position




Body Position Description	Diagrams	Major Desired Actions
1. Body as compact as possible, with the back rounded and the legs together.		1. Legs together with shins at the surface of the water and tucked tightly to the front of the body.
2. Heels close to buttocks.		2. Compact tuck. Chin tucked in.
3. Head close to knees.		

Figure – 311 KIP

DIFFICULTY – 1.6

From a **Back Layout Position** the knees, shins and toes are drawn along the surface of the water to assume a **Tuck Position**. With continuous motion the tuck becomes more compact and a partial Somersault Back Tuck is executed until the shins are perpendicular to the surface of the water. The trunk unrolls as the legs are straightened to assume a **Vertical Position** midway between the former vertical line through the hips and the former vertical line through the head and shins. A *Vertical Descent* is executed.






					Total
NVT=	3.0	2.0	23.0	14.0	42
PV =	0.71	0.48	5.48	3.33	10

Figure Description	NVT	Diagrams	Major Desired Actions
--------------------	-----	----------	-----------------------

1. From a **Back Layout Position** the knees, shins and toes are drawn along the surface of the water to assume a **Tuck Position**. With continuous motion the tuck becomes more compact and a partial Somersault Back Tuck is executed until the shins are perpendicular to the surface of the water

3.0

2.0



1.1 See BP 1 **Back Layout** and BP 9 **Tuck Positions**. With the head and shoulders remaining stationary, the knees, shins and toes are drawn to the body to assume a tight tuck at the position occupied by the trunk in the **Back Layout Position**.
 1.2 There is continuous motion from the initiation of the leg draw to achievement of the inverted BP 9 **Tuck Position**.

2. The trunk unrolls as the legs are straightened to assume a **Vertical Position** midway between the former vertical line through the hips and the former vertical line through the head and shins.


23.0




2.1 BP 6 **Vertical Position** and maximum height achieved simultaneously.
 2.2 The **Vertical Position** is held only long enough to define the position and to demonstrate completion of the transition prior to the descent.

Figure – 311 KIP (cont.)




DIFFICULTY – 1.6

Figure Description	NVT	Diagrams	Major Desired Actions
3. A <i>Vertical Descent</i> is executed.	14.0		3. See BM 10 <i>Vertical Descent</i> .

BP 1 Back Layout Position

Body Position Description	Diagrams	Major Desired Actions
1. Body extended with face, chest, thighs and feet at the surface of the water.		1. Gives the impression that the body is stretched horizontally to its maximum. Front of the trunk will also be at the surface of the water.
2. Head (ears specifically), hips and ankles in horizontal alignment.		2. Judgement is made by checking visual points of the horizontal alignment: ears, shoulder joints, hip joints and ankles. This imaginary line should also pass through the middle of the side of the trunk.

BP 9 Tuck Position

Body Position Description	Diagrams	Major Desired Actions
1. Body as compact as possible, with the back rounded and the legs together.		1. Legs together with shins at the surface of the water and tucked tightly to the front of the body.
2. Heels close to buttocks.		2. Compact tuck. Chin tucked in.
3. Head close to knees.		3. In BP 9 inverted Tuck Position shins are perpendicular to the surface of the water, buttocks remain at the surface and the water level is between the ankle and mid foot.

BP 6 Vertical Position


Body Position Description	Diagrams	Major Desired Actions
1. Body extended perpendicular to the surface of the water; legs together, head downward.		1. Full extension of the body.

Figure – 311 KIP (cont.)

DIFFICULTY – 1.6

BP 6 Vertical Position (cont.)

Body Position Description	Diagrams	Major Desired Actions
2. Head (ears specifically), hips and ankles in line.		2. Judgement is made by checking visual points of the vertical alignment: ears, shoulder joints, hip joints and ankles.

BM 10 Vertical Descent

Basic Movement Description	NVT	Diagrams	Major Desired Actions
1. Maintaining a Vertical Position the body descends along its longitudinal axis until the toes are submerged.	14.0		1. See BP 6 Vertical Position . The tempo of the descent is uniform and at the same speed as the rest of the figure.

Kip 301a – 301g, 311j – A Kip is executed to **Vertical Position**. The designated *Twist* or *Spin* is performed.

Note: Refer to Section BM 12 Twists & Twist Allowances and Section BM 13 Spins & Spin Allowances.

Figure – 311a KIP ½ TWIST

DIFFICULTY – 2.0

						Total
NVT=	3.0	2.0	23.0	21.0	14.0	63
PV =	0.48	0.32	3.65	3.33	2.22	10

Figure – 311b KIP FULL TWIST

DIFFICULTY – 2.2

						Total
NVT=	3.0	2.0	23.0	32.0	14.0	74
PV =	0.41	0.27	3.11	4.32	1.89	10

Figure – 311 KIP (cont.)

Kip 301a – 301g, 311j – A Kip is executed to **Vertical Position**. The designated *Twist* or *Spin* is performed.

Note: Refer to **Section BM 12 Twists & Twist Allowances** and **Section BM 13 Spins & Spin Allowances**.

Figure – 311c KIP TWIRL
DIFFICULTY – 2.1







						Total
NVT=	3.0	2.0	23.0	26.0	14.0	68
PV =	0.44	0.29	3.38	3.82	2.06	10

Figure – 311d KIP SPINNING 180°
DIFFICULTY – 1.7







						Total
NVT=	3.0	2.0	23.0	16.0	0	44
PV =	0.65	0.45	5.23	3.64	0	10

Figure – 311e KIP SPINNING 360°
DIFFICULTY – 1.7







						Total
NVT=	3.0	2.0	23.0	19.0	0	47
PV =	0.64	0.43	4.89	4.04	0	10

Figure – 311 KIP (cont.)

Kip 301a – 301g, 311j – A Kip is executed to **Vertical Position**. The designated *Twist* or *Spin* is performed. For 311j Kip Combined Spin (360° + 360°) the Combined Spin is performed rapidly.

Note: Refer to Section BM 12 Twists & Twist Allowances and Section BM 13 Spins & Spin Allowances.

Figure – 311f KIP CONTINUOUS SPIN (720°)
DIFFICULTY – 2.0

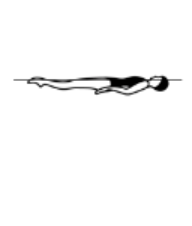

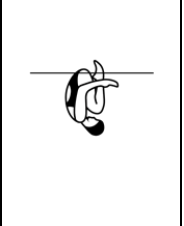
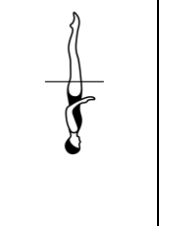
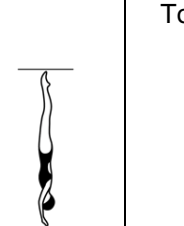
					Total
NVT=	3.0	2.0	23.0	34.0	62
PV =	0.48	0.32	3.71	5.48	10

Figure – 311g KIP TWIST SPIN
DIFFICULTY – 2.2


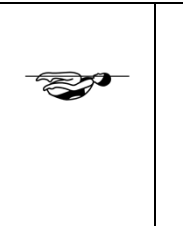
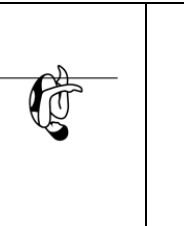
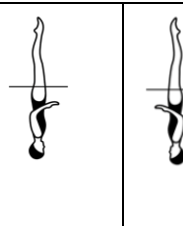
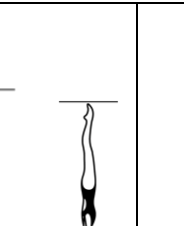
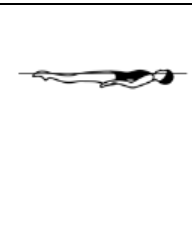
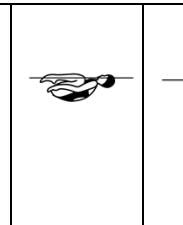
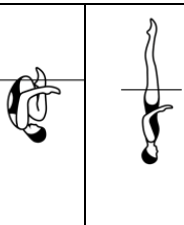
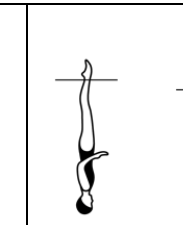
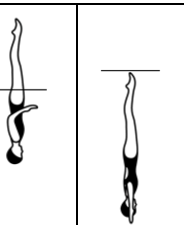
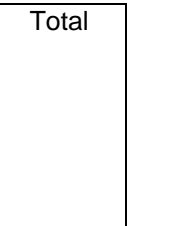
					Total
NVT=	3.0	2.0	23.0	48.0	76
PV =	0.39	0.26	3.03	6.32	10

Figure – 311j KIP COMBINED SPIN (360° + 360°)*
DIFFICULTY – 2.4

						Total
NVT=	3.0	2.0	23.0	40.0	14.0	82
PV =	0.37	0.24	2.80	4.88	1.71	10

*** Note: Refer to Section BM 13 Spins. There is no Spin Allowance for Combined Spins.**

Figure – 311 KIP (cont.)

Kip 301h and 301i – A Kip is executed to **Vertical Position**. A *Vertical Descent* is executed to ankle level. The designated *ascending Spin* is performed.

Note: Refer to Section BM 13 Spins & Spin Allowances.

Figure – 311h KIP SPIN UP 180°
DIFFICULTY – 2.2








							Total
NVT=	3.0	2.0	23.0	14.0	20.0	14.0	76
PV =	0.39	0.26	3.03	1.84	2.63	1.84	10

Figure – 311i KIP SPIN UP 360°
DIFFICULTY – 2.3








							Total
NVT=	3.0	2.0	23.0	14.0	21.0	14.0	77
PV =	0.39	0.26	2.99	1.82	2.73	1.82	10

Figure – 312 KIP SPLIT

DIFFICULTY – 2.3

From a **Back Layout Position** the knees, shins and toes are drawn along the surface of the water to assume a **Tuck Position**. With continuous motion the tuck becomes more compact and a partial Somersault Back Tuck is executed until the shins are perpendicular to the surface of the water. The trunk unrolls as the legs are straightened to assume a **Vertical Position** midway between the former vertical line through the hips and the former vertical line through the head and shins. The legs are lowered symmetrically to a **Split Position**. The legs are joined to resume a **Vertical Position**. A *Vertical Descent* is executed.








							Total
NVT=	3.0	2.0	23.0	17.0	20.0	14.0	79
PV =	0.38	0.25	2.91	2.15	2.53	1.77	10

Figure Description	NVT	Diagrams	Major Desired Actions
--------------------	-----	----------	-----------------------

1. From a **Back Layout Position** the knees, shins and toes are drawn along the surface of the water to assume a **Tuck Position**. With continuous motion the tuck becomes more compact and a partial Somersault Back Tuck is executed until the shins are perpendicular to the surface of the water.

3.0
2.0



1.1 See BP 1 **Back Layout** and BP 9 **Tuck Positions**. With the head and shoulders remaining stationary, the knees, shins and toes are drawn to the body to assume a tight tuck at the position occupied by the trunk in the **Back Layout Position**.
1.2 There is continuous motion from the initiation of the leg draw to achievement of the inverted BP 9 **Tuck Position**.

2. The trunk unrolls as the legs are straightened to assume a **Vertical Position** midway between the former vertical line through the hips and the former vertical line through the head and shins.




23.0



2.1 BP 6 **Vertical Position** and maximum height achieved simultaneously.
2.2 The **Vertical Position** is held only long enough to define the position and to demonstrate completion of the transition.

Figure – 312 KIP SPLIT (cont.)

DIFFICULTY – 2.3

Figure Description	NVT	Diagrams	Major Desired Actions
3. The legs are lowered symmetrically to a Split Position .	17.0		3. See BP 16a Surface Split Position . Both legs remain equidistant from the surface of the water at all times. Height remains constant.
4. The legs are joined to resume a Vertical Position .	20.0		4.1 Height remains constant as legs are lifted to BP 6 Vertical Position . 4.2 Both legs remain equidistant from the surface of the water and achieve Vertical Position simultaneously. 4.3 The legs split and rejoin in the same vertical line. 4.4 Vertical height is the same for both vertical positions.
5. A <i>Vertical Descent</i> is executed.	14.0		5. See BM 10 <i>Vertical Descent</i> .

BP 1 Back Layout Position






Body Position Description	Diagrams	Major Desired Actions
1. Body extended with face, chest, thighs and feet at the surface of the water.		1. Gives the impression that the body is stretched horizontally to its maximum. Front of the trunk will also be at the surface of the water.
2. Head (ears specifically), hips and ankles in horizontal alignment.		2. Judgement is made by checking visual points of the horizontal alignment: ears, shoulder joints, hip joints and ankles. This imaginary line should also pass through the middle of the side of the trunk.

Figure – 312 KIP SPLIT (cont.)
DIFFICULTY – 2.3
BP 9 Tuck Position

Body Position Description	Diagrams	Major Desired Actions
1. Body as compact as possible, with the back rounded and the legs together.		1. Legs together with shins at the surface of the water and tucked tightly to the front of the body.
2. Heels close to buttocks.		2. Compact tuck. Chin tucked in.
3. Head close to knees.		3. In BP 9 inverted Tuck Position shins are perpendicular to the surface of the water, buttocks remain at the surface and the water level is between the ankle and mid foot.

BP 6 Vertical Position

Body Position Description	Diagrams	Major Desired Actions
1. Body extended perpendicular to the surface of the water; legs together, head downward.		1. Full extension of the body.
2. Head (ears specifically), hips and ankles in line.		2. Judgement is made by checking visual points of the vertical alignment: ears, shoulder joints, hip joints and ankles.

BP 16 Split Position



Body Position Description	Diagrams	Major Desired Actions
1. Legs evenly split forward and back.		1. Full extension of the legs at or above the surface of the water.
2. The legs are parallel to the surface of the water.		
3. Lower back arched, with hips, shoulders and head on a vertical line.		
4. 180° angle between the extended legs (flat split), with inside of each leg aligned on opposite sides of a horizontal line, regardless of the height of the hips.		4. Flat split. Hip joints and shoulder joints on a horizontal line, with both of these alignments 'square' and parallel to each other.

Figure – 312 KIP SPLIT (cont.)
DIFFICULTY – 2.3
BP 16 Split Position (cont.)

Body Position Description	Diagrams	Major Desired Actions
a) Surface Split Position 1. Legs are dry at the surface of the water.		1. Full extension of the legs. Crotch and legs dry at the surface of the water.

BM 10 Vertical Descent

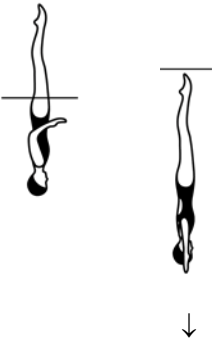
Basic Movement Description	NVT	Diagrams	Major Desired Actions
1. Maintaining a Vertical Position the body descends along its longitudinal axis until the toes are submerged.	14.0		1. See BP 6 Vertical Position . The tempo of the descent is uniform and at the same speed as the rest of the figure.

Figure – 313 KIP SPLIT CLOSING 180°

DIFFICULTY – 2.2

From a **Back Layout Position** the knees, shins and toes are drawn along the surface of the water to assume a **Tuck Position**. With continuous motion the tuck becomes more compact and a partial Somersault Back Tuck is executed until the shins are perpendicular to the surface of the water. The trunk unrolls as the legs are straightened to assume a **Vertical Position** midway between the former vertical line through the hips and the former vertical line through the head and shins. The legs are lowered symmetrically to a **Split Position**. During a 180° rotation, the legs are closed symmetrically to a **Vertical Position**. A *Vertical Descent* is executed.








							Total
NVT=	3.0	2.0	23.0	17.0	17.0	14.0	76
PV =	0.39	0.26	3.03	2.24	2.24	1.84	10

Figure Description	NVT	Diagrams	Major Desired Actions
--------------------	-----	----------	-----------------------

1. From a **Back Layout Position** the knees, shins and toes are drawn along the surface of the water to assume a **Tuck Position**. With continuous motion the tuck becomes more compact and a partial Somersault Back Tuck is executed until the shins are perpendicular to the surface of the water.

3.0



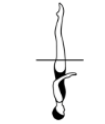
1. See Figure 312 Kip Split steps 1 - 3.

2.0



2. The trunk unrolls as the legs are straightened to assume a **Vertical Position** midway between the former vertical line through the hips and the former vertical line through the head and shins.

23.0

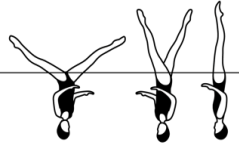



17.0



3. The legs are lowered symmetrically to a **Split Position**.

Figure – 313 KIP SPLIT CLOSING 180° (cont.)
DIFFICULTY – 2.2

Figure Description	NVT	Diagrams	Major Desired Actions
4. During a 180° rotation, the legs are closed symmetrically to Vertical Position .	17.0		4.1 The rotation and the closing action of the legs occurs simultaneously, with completion of the rotation and achievement of BP 6 Vertical Position occurring as the feet join. 4.2 Both legs are always equidistant from the surface of the water. 4.3 Longitudinal axis maintained throughout the rotation. 4.4 Hip height remains constant throughout the closing action.
5. A <i>Vertical Descent</i> is executed.	14.0		5. See BM 10 <i>Vertical Descent</i> .

See Figure 312 Kip Split for **Back Layout Position, Tuck Position, Vertical Position, Split Position** and *Vertical Descent Basic Movement*.

Figure – 314 KIP SPLIT OPEN 360°

DIFFICULTY – 2.9

From a **Back Layout Position** the knees, shins and toes are drawn along the surface of the water to assume a **Tuck Position**. With continuous motion the tuck becomes more compact and a partial Somersault Back Tuck is executed until the shins are perpendicular to the surface of the water. The trunk unrolls as the legs are straightened to assume a **Vertical Position** midway between the former vertical line through the hips and the former vertical line through the head and shins. The legs are lowered symmetrically to a **Split Position**. A 360° rotation is executed, with the legs symmetrically closing to Vertical Position at 180° of the rotation before opening to resume a **Split Position** with the same leg forward at the completion of the 360°. A *Walkout Front* is executed.




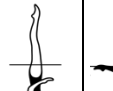

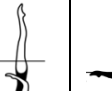



									Total
NVT=	3.0	2.0	23.0	17.0	17.0	20.0	23.0	7.0	112
PV =	0.27	0.18	2.05	1.52	1.52	1.79	2.05	0.63	10






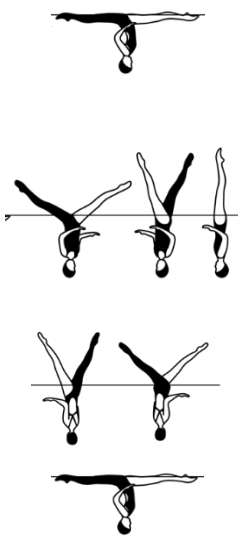
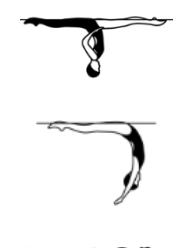
Figure Description	NVT	Diagrams	Major Desired Actions
1. From a Back Layout Position the knees, shins and toes are drawn along the surface of the water to assume a Tuck Position . With continuous motion the tuck becomes more compact and a partial Somersault Back Tuck is executed until the shins are perpendicular to the surface of the water.	3.0		1. See Figure 312 Kip Split for steps 1 - 3.
2. The trunk unrolls as the legs are straightened to assume a Vertical Position midway between the former vertical line through the hips and the former vertical line through the head and shins.	2.0		
3. The legs are lowered symmetrically to a Split Position .	23.0		
	17.0		
			

Figure – 314 KIP SPLIT OPEN 360° (cont.)

DIFFICULTY – 2.9

Figure Description	NVT	Diagrams	Major Desired Actions
<p>4. A 360° rotation is executed, with the legs symmetrically closing to Vertical Position at 180° of the rotation before opening to resume a Split Position with the same leg forward at the completion of the 360°.</p> <p>It is important to note that the leg forward in the first Split Position remains the same leg forward in the second Split Position.</p> <p>The diagram shows both Split Positions with the right (R) leg forward however either leg can be used to perform the action.</p>			<p>4.1 Both legs always equidistant from the surface of the water. Height remains constant, with no pause in BP 6 Vertical Position.</p> <p>4.2 During the closing and opening of the split positions, the legs move evenly through time and space to complete the rotation as BP 16a Surface Split Position is achieved.</p> <p>4.3 Longitudinal axis maintained throughout rotation.</p> <p>4.4 Hip height remains constant throughout the rotation.</p>
<p>5. A <i>Walkout Front</i> is executed.</p>	<p>23.0</p> <p>7.0</p>		<p>5. See BM 6a <i>Walkout Front</i> and see BM 5 <i>Arch to Back Layout Position</i></p>

See Figure 312 Kip Split for **Back Layout Position, Tuck Position, Vertical Position and Split Position**.

BP 13 Surface Arch Position



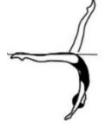

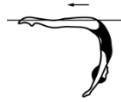

Body Position Description	Diagrams	Major Desired Actions
<p>1. Lower back arched with hips, shoulders and head on a vertical line.</p>		<p>1. Hip joints and shoulder joints on a horizontal line with both of these alignments 'square' and parallel to one another. Head (ears specifically) in line with shoulders.</p>
<p>2. Legs together and at the surface of the water.</p>		<p>2. Hips joints at the surface of the water.</p>

Figure – 314 KIP SPLIT OPEN 360° (cont.)

DIFFICULTY – 2.9

BM 6 Walkouts

Basic Movement Description	NVT	Diagrams	Major Desired Actions
<p>1. These movements start in a Split Position unless otherwise specified in the figure description. The hips remain stationary as one leg is lifted in an arc over the surface of the water to meet the opposite leg.</p> <p>a) Walkout Front</p> <p>2. The front leg is lifted in a 180° arc over the surface of the water to meet the opposite leg in a Surface Arch Position and with continuous movement an <i>Arch to Back Layout Finish Action</i> is executed.</p>	<p>23.0</p> <p>7.0</p>	    	<p>1. See BP 16a Surface Split Position.</p> <p>2.1 Hip height remains constant and at the surface of the water. 2.2 Arcing leg moves continuously with uniform motion. 2.3 Both legs maintain full extension. 2.4 The trunk remains stationary until the feet join. 2.5 No pause in BP 13 Surface Arch Position, however an accurate surface arch must be evident before the body begins to rise and straighten. 2.6 Foot first surfacing motion begins when the feet are joined. 2.7 See BP 13 Surface Arch Position and BM 5 <i>Arch to Back Layout Finish Action</i>.</p>

BM 5 Arch to Back Layout Finish Action



Basic Movement Description	NVT	Diagrams	Major Desired Actions
<p>1. From a Surface Arch Position the hips, chest and face surface sequentially at the same point with foot first movement to a Back Layout Position until the head occupies the position of the hips at the beginning of this action.</p>	<p>7.0</p>	 	<p>1. See BP 13 Surface Arch Position. Sharp arch in the lower back. The body rises, straightens and moves along the surface of the water with a stationary BP 1 Back Layout Position achieved as the face surfaces. Full extension maintained throughout.</p>

Figure – 315 SEAGULL
DIFFICULTY – 2.2

From a **Back Layout Position** the knees, shins and toes are drawn along the surface of the water to assume a **Tuck Position**. With continuous motion the tuck becomes more compact and a partial Somersault Back Tuck is executed until the shins are perpendicular to the surface of the water. The trunk rapidly unrolls as the legs are straightened to assume a **Vertical Position** midway between the former vertical line through the hips and the former vertical line through the head and the shins. The legs are rapidly lowered symmetrically to **Split Position**. The legs are rapidly joined to resume **Vertical Position**. A *Vertical Descent* is executed at the same tempo as the movement executed from the **Back Layout Position** until the shins are perpendicular to the surface of the water.








							Total
NVT=	3.0	2.0	20.0	19.0	16.0	14.0	74
PV =	0.41	0.27	2.70	2.57	2.16	1.89	10








Figure Description	NVT	Diagrams	Major Desired Actions
1. From a Back Layout Position the knees, shins and toes are drawn along the surface of the water to assume a Tuck Position . With continuous motion the tuck becomes more compact and a partial Somersault Back Tuck is executed until the shins are perpendicular to the surface of the water.	3.0 2.0	  	1.1 See BP 1 Back Layout and BP 9 Tuck Positions . With the head and shoulders remaining stationary, the knees, shins and toes are drawn to the body to assume a tight tuck at the position occupied by the trunk in the Back Layout Position . 1.2 There is continuous motion from the initiation of the knee draw to achievement of the inverted BP 9 Tuck Position .
2. The trunk rapidly unrolls as the legs are straightened to assume a Vertical Position midway between the former vertical line through the hips and the former vertical line through the head and the shins.	20.0		2.1 With a rapid motion, BP 6 Vertical Position and maximum height are achieved simultaneously. 2.2 The Vertical Position is held only long enough to define the position and to demonstrate completion of the transition prior to the Split Position .

Figure – 315 SEAGULL (cont.)

DIFFICULTY – 2.2

Figure Description	NVT	Diagrams	Major Desired Actions
3. The legs are lowered rapidly and symmetrically to Split Position .	19.0		3. With rapid motion, BP 16a Surface Split Position is achieved. Both legs remain equidistant from the surface of the water at all times.
4. The legs are rapidly joined to resume Vertical Position .	16.0		4.1 With rapid motion, the height remains constant as legs are lifted to BP 6 Vertical Position . 4.2 Both legs remain equidistant from the surface of the water and achieve Vertical Position simultaneously. 4.3 The legs split and rejoin in the same vertical line.
5. A <i>Vertical Descent</i> is executed at the same tempo as the movement executed from the Back Layout Position until the shins are perpendicular to the surface of the water.	14.0		5. See BM 10 <i>Vertical Descent</i> .

See Figure 312 Kip Split for **Back Layout Position, Tuck Position, Vertical Position, Split Position** and *Vertical Descent Basic Movement*.

Seagull 315c – A Seagull is executed to the second **Vertical Position**. A *Twirl* is executed followed by a rapid *Vertical Descent*.

Note: Refer to Section BM 12 Twists & Twist Allowances.

Figure – 315c SEAGULL TWIRL

DIFFICULTY – 2.7







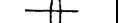

								Total
NVT=	3.0	2.0	20.0	19.0	16.0	26.0	13.0	99
PV =	0.30	0.20	2.02	1.92	1.62	2.63	1.31	10

Figure – 315 SEAGULL (cont.)
DIFFICULTY – 2.2

Seagull 315d – 315f – A Seagull is executed to the second **Vertical Position**. The designated *Spin* is executed.

Note: Refer to Section BM 13 Spins & Spin Allowances.

Figure – 315d SEAGULL SPINNING 180°
DIFFICULTY – 2.2






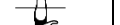


								Total
NVT=	3.0	2.0	20.0	19.0	16.0	16.0	0	76
PV =	0.39	0.26	2.63	2.50	2.11	2.11	0	10

Figure – 315e SEAGULL SPINNING 360°
DIFFICULTY – 2.3









								Total
NVT=	3.0	2.0	20.0	19.0	16.0	19.0	0	79
PV =	0.38	0.25	2.53	2.41	2.03	2.41	0	10

Figure – 315f SEAGULL CONTINUOUS SPIN (720°)
DIFFICULTY – 2.6








							Total
NVT=	3.0	2.0	20.0	19.0	16.0	34.0	94
PV =	0.32	0.21	2.13	2.02	1.70	3.62	10

Figure – 315 SEAGULL (cont.)

Seagull 315h and Seagull 315i – A Seagull is executed to the second **Vertical Position**. A rapid *Vertical Descent* is executed to ankle level. The designated *ascending Spin* is executed followed by a rapid *Vertical Descent*.

****ascending Spin:** The *ascending Spin* should NOT be performed rapidly but should be performed as the body rises and rotates simultaneously, evenly and at the same tempo as the root figure **Back Layout** to **inverted Tuck Position**.

Note: Refer to Section BM 13 Spins & Spin Allowances.

Figure – 315h SEAGULL SPIN UP 180°
DIFFICULTY – 2.8


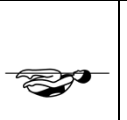
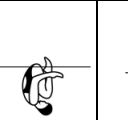
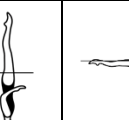
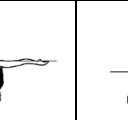
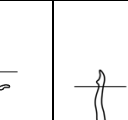
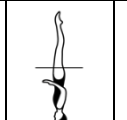
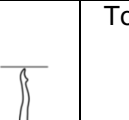
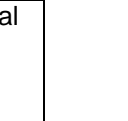
									Total
NVT=	3.0	2.0	20.0	19.0	16.0	14.0	20.0	13.0	107
PV =	0.28	0.19	1.87	1.78	1.50	1.31	1.87	1.21	10

Figure – 315i SEAGULL SPIN UP 360°
DIFFICULTY – 2.8


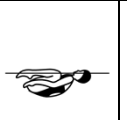
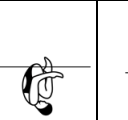
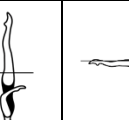
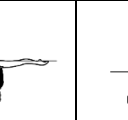
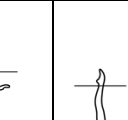
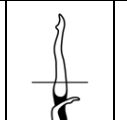
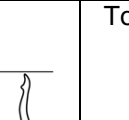
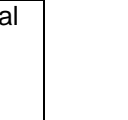
									Total
NVT=	3.0	2.0	20.0	19.0	16.0	14.0	21.0	13.0	108
PV =	0.28	0.19	1.85	1.76	1.48	1.30	1.94	1.20	10

Figure – 316 KIPNUS

DIFFICULTY – 1.4

From a **Back Layout Position** the knees, shins and toes are drawn along the surface of the water to assume a **Tuck Position**. With continuous motion the tuck becomes more compact and a partial Somersault Back Tuck is executed until the shins are perpendicular to the surface of the water. The trunk unrolls as the legs assume a **Bent Knee Vertical Position** midway between the former vertical line through the hips and the former vertical line through the head and the shins. A *Vertical Descent* is executed in a **Bent Knee Vertical Position**.






					Total
NVT=	3.0	2.0	15.0	9.0	29
PV =	1.03	0.69	5.17	3.10	10

Figure Description	NVT	Diagrams	Major Desired Actions
--------------------	-----	----------	-----------------------

1. From a **Back Layout Position** the knees, shins and toes are drawn along the surface of the water to assume a **Tuck Position**. With continuous motion the tuck becomes more compact and a partial Somersault Back Tuck is executed until the shins are perpendicular to the surface of the water.

3.0



2.0



1.1 See BP 1 **Back Layout** and BP 9 **Tuck Positions**. With the head and shoulders remaining stationary, the knees, shins and toes are drawn to the body to assume a tight tuck at the position occupied by the trunk in the **Back Layout Position**.
1.2 There is continuous motion from the initiation of the knee draw to achievement of the inverted BP 9 **Tuck Position**.

2. The trunk unrolls as the legs assume a **Bent Knee Vertical Position** midway between the former vertical line through the hips and the former vertical line through the head and the shins.


15.0




2.1 BP 14c **Bent Knee Vertical Position** and maximum height achieved simultaneously.
2.2 This position is held only long enough to define the position and to demonstrate completion of the transition.
2.3 The toes of the bent leg remain in contact with the extended leg throughout the unrolling action.

Figure – 316 KIPNUS (cont.)

DIFFICULTY – 1.4

Figure Description	NVT	Diagrams	Major Desired Actions
3. A <i>Vertical Descent</i> is executed in a Bent Knee Vertical Position .	9.0		3. See BM 10 <i>Vertical Descent</i>

BP 1 Back Layout Position

Body Position Description	Diagrams	Major Desired Actions
1. Body extended with face, chest, thighs and feet at the surface of the water.		1. Gives the impression that the body is stretched horizontally to its maximum. Front of the trunk will also be at the surface of the water.
2. Head (ears specifically), hips and ankles in horizontal alignment.		2. Judgement is made by checking visual points of the horizontal alignment: ears, shoulder joints, hip joints and ankles. This imaginary line should also pass through the middle of the side of the trunk.

BP 9 Tuck Position




Body Position Description	Diagrams	Major Desired Actions
1. Body as compact as possible, with the back rounded and the legs together.		1. Legs together with shins at the surface of the water and tucked tightly to the front of the body.
2. Heels close to buttocks.		2. Compact tuck. Chin tucked in.
3. Head close to knees.		3. In BP 9 inverted Tuck Position shins are perpendicular to the surface of the water, buttocks remain at the surface and the water level is between the ankle and mid foot.

Figure – 316 KIPNUS (cont.)

DIFFICULTY – 1.4

BP 14 Bent Knee Position

Body Position Description	Diagrams	Major Desired Actions
One leg bent with the toe of the bent leg in contact with the inside of the extended leg at the knee or higher.		The relationship of the toe of the bent leg to the extended leg may vary depending on the figure but should remain constant once established, and not extend in front of or behind the extended leg.

c) Bent Knee Vertical Position

1. Body extended in **Vertical Position** with the thigh of the bent leg parallel to the surface of the water.



1. In BP 6 **Vertical Position** the alignment of the extended leg, trunk and head remains constant.

BM 10 Vertical Descent in Bent Knee Vertical Position



Basic Movement Description	NVT	Diagrams	Major Desired Actions
1. Maintaining a Bent Knee Vertical Position , the body descends along its longitudinal axis until the toes are submerged.	9.0	 	1. See BP 14c Bent Knee Vertical Position . The tempo of the descent is uniform and at the same speed as the rest of the figure.

Figure – 317 KIPNUS VARIANT
DIFFICULTY – 1.9

From a **Back Layout Position** the knees, shins and toes are drawn along the surface of the water to assume a **Tuck Position**. With continuous motion the tuck becomes more compact and a partial Somersault Back Tuck is executed until the shins are perpendicular to the surface of the water. The trunk unrolls as the legs assume a **Bent Knee Vertical Position** midway between the former vertical line through the hips and the former vertical line through the head and the shins. A *Full Twist* is executed to a **Vertical Position** as the bent leg is extended to meet the vertical leg. A *Vertical Descent* is executed.







						Total
NVT=	3.0	2.0	15.0	22.0	14.0	56
PV =	0.54	0.36	2.68	3.93	2.50	10








Figure Description	NVT	Diagrams	Major Desired Actions
1. From a Back Layout Position the knees, shins and toes are drawn along the surface of the water to assume a Tuck Position . With continuous motion the tuck becomes more compact and a partial Somersault Back Tuck is executed until the shins are perpendicular to the surface of the water.	3.0		1. See Figure 316 Kipnus steps 1 - 2.
2. The trunk unrolls as the legs assume a Bent Knee Vertical Position midway between the former vertical line through the hips and the former vertical line through the head and the shins	2.0		
	2.0		
	15.0		

Figure – 317 KIPNUS VARIANT (cont.)

DIFFICULTY – 1.9

Figure Description	NVT	Diagrams	Major Desired Actions
3. A <i>Full Twist</i> is executed to a Vertical Position as the bent leg is extended to meet the vertical leg.	22.0	 	<p>3.1 See BP 6 Vertical Position and BM 12 Twists. Vertical alignment and maximum height maintained during continuous straightening of the bent leg which is completed simultaneously with completion of the <i>Full Twist</i>.</p> <p>3.2 The height and body alignment remain constant during extension of the bent leg.</p> <p>3.3 After the <i>Full Twist</i> is completed the Vertical Position is held only long enough to define the position and to demonstrate completion of the transition prior to descent.</p>
4. A <i>Vertical Descent</i> is executed.	14.0		4. See BM 10 Vertical Descent

See Figure 316 Kipnus for **Back Layout Position, Tuck Position and Bent Knee Vertical Position**.

Note: Refer to Section BM 12 Twists & Twist Allowances.

BP 6 Vertical Position


Body Position Description	Diagrams	Major Desired Actions
1. Body extended perpendicular to the surface of the water; legs together, head downward.		1. Full extension of the body.

Figure – 317 KIPNUS VARIANT (cont.)
DIFFICULTY – 1.9
BP 6 Vertical Position (cont.)

Body Position Description	Diagrams	Major Desired Actions
2. Head (ears specifically), hips and ankles in line.		2. Judgement is made by checking visual points of the vertical alignment: ears, shoulder joints, hip joints and ankles.

BM 10 Vertical Descent

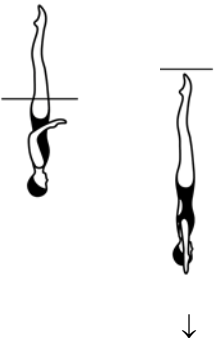
Basic Movement Description	NVT	Diagrams	Major Desired Actions
1. Maintaining a Vertical Position the body descends along its longitudinal axis until the toes are submerged.	14.0		1. See BP 6 Vertical Position . The tempo of the descent is uniform and at the same speed as the rest of the figure.

Figure – 318 KIP BENT KNEE
DIFFICULTY – 1.8

From a **Back Layout Position** the knees, shins and toes are drawn along the surface of the water to assume a **Tuck Position**. With continuous motion the tuck becomes more compact and a partial Somersault Back Tuck is executed until the shins are perpendicular to the surface of the water. The trunk unrolls as the legs assume a **Bent Knee Vertical Position** midway between the former vertical line through the hips and the former vertical line through the head and the shins. The bent leg is extended to a **Vertical Position**. A *Vertical Descent* is executed.







						Total
NVT=	3.0	2.0	15	16.5	14.0	50.5
PV =	0.59	0.40	2.97	3.27	2.77	10








Figure Description	NVT	Diagrams	Major Desired Actions
1. From a Back Layout Position a partial Somersault Back Tuck is executed until the shins are perpendicular to the surface of the water.	3.0	 	1. See Figure 316 Kipnus steps 1 - 2.
2. The trunk unrolls as the legs assume a Bent Knee Vertical Position midway between the former vertical line through the hips and the former vertical line through the head and the shins.	2.0 15.0	 	

Figure – 318 KIP BENT KNEE (cont.)
DIFFICULTY – 1.8

Figure Description	NVT	Diagrams	Major Desired Actions
3. The bent leg is extended to a Vertical Position .	16.5	 	<p>3.1 BP 14c Bent Knee Vertical Position and maximum height achieved simultaneously.</p> <p>3.2 Vertical alignment maintained during extension of the bent leg.</p> <p>3.3 Height and body alignment remain constant during extension of the bent leg.</p> <p>3.4 The Vertical Position is held only long enough to define the position and to demonstrate completion of the transition prior to descent.</p>
4. A <i>Vertical Descent</i> is executed.	14.0		<p>4. See BM 10 <i>Vertical Descent</i>.</p>

See Figure 316 Kipnus for **Back Layout Position, Tuck Position, Bent Knee Vertical Position** and 317 Kipnus Variant for **Vertical Position & Vertical Descent Basic Movement**.

Figure – 319 KIPSWIRL

DIFFICULTY – 1.7

From a **Back Layout Position** the knees, shins and toes are drawn along the surface of the water to assume a **Tuck Position**. With continuous motion the tuck becomes more compact and a partial Somersault Back Tuck is executed until the shins are perpendicular to the surface of the water. As the trunk unrolls and the legs are straightened a 360° rotation is executed to assume a **Vertical Position**. A *Vertical Descent* is executed.






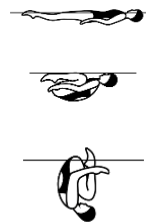
					Total
NVT=	3.0	2.0	25.0	14.0	44
PV =	0.68	0.45	5.68	3.18	10

Figure Description	NVT	Diagrams	Major Desired Actions
--------------------	-----	----------	-----------------------

1. From a **Back Layout Position** the knees, shins and toes are drawn along the surface of the water to assume a **Tuck Position**. With continuous motion the tuck becomes more compact and a partial Somersault Back Tuck is executed until the shins are perpendicular to the surface of the water.

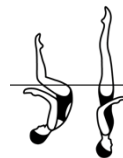
3.0
2.0



1.1 See BP 1 **Back Layout** and BP 9 **Tuck Positions**. With the head and shoulders remaining stationary, the knees, shins and toes are drawn to the body to assume a tight tuck at the position occupied by the trunk in the **Back Layout Position**.
1.2 There is continuous motion from the initiation of the leg draw to achievement of the inverted BP 9 **Tuck Position**.

2. As the trunk unrolls and the legs are straightened a 360° rotation is executed to assume a **Vertical Position**.


25.0




2.1 BP 6 **Vertical Position** and maximum height achieved simultaneously.
2.2 Continuous straightening of the bent legs is completed simultaneously with the completion of the 360° rotation.
2.3 The **Vertical Position** is held only long enough to define the position and to demonstrate completion of the transition prior to the descent.

Figure – 319 KIPSWIRL (cont.)

DIFFICULTY – 1.7

Figure Description	NVT	Diagrams	Major Desired Actions
3. A <i>Vertical Descent</i> is executed.	14.0		3. See BM 10 <i>Vertical Descent</i> .

BP 1 Back Layout Position

Body Position Description	Diagrams	Major Desired Actions
1. Body extended with face, chest, thighs and feet at the surface of the water.		1. Gives the impression that the body is stretched horizontally to its maximum. Front of the trunk will also be at the surface of the water.
2. Head (ears specifically), hips and ankles in horizontal alignment.		2. Judgement is made by checking visual points of the horizontal alignment: ears, shoulder joints, hip joints and ankles. This imaginary line should also pass through the middle of the side of the trunk.

BP 9 Tuck Position




Body Position Description	Diagrams	Major Desired Actions
1. Body as compact as possible, with the back rounded and the legs together.		1. Legs together with shins at the surface of the water and tucked tightly to the front of the body.
2. Heels close to buttocks.		2. Compact tuck. Chin tucked in.
3. Head close to knees.		3. In BP 9 inverted Tuck Position shins are perpendicular to the surface of the water, buttocks remain at the surface and the water level is between the ankle and mid foot.

Figure – 319 KIPSWIRL (cont.)

DIFFICULTY – 1.7

BP 6 Vertical Position

Body Position Description	Diagrams	Major Desired Actions
1. Body extended perpendicular to the surface of the water; legs together, head downward.		1. Full extension of the body.
2. Head (ears specifically), hips and ankles in line.		2. Judgement is made by checking visual points of the vertical alignment: ears, shoulder joints, hip joints and ankles.

BM 10 Vertical Descent

Basic Movement Description	NVT	Diagrams	Major Desired Actions
1. Maintaining a Vertical Position the body descends along its longitudinal axis until the toes are submerged.	14.0		1. See BP 6 Vertical Position . The tempo of the descent is uniform and at the same speed as the rest of the figure.

Kipswirl 319c – 319f – A Kipswirl is executed to **Vertical Position**. The designated *Twist* or *Spin* is executed.

Note: Refer to Section **BM 12 Twists & Twist Allowances** and Section **BM 13 Spins & Spin Allowances**.

Figure – 319c KIPSWIRL TWIRL

DIFFICULTY – 2.1

							Total
NVT=		3.0	2.0	25.0	26.0	14.0	70
PV =		0.43	0.29	3.57	3.71	2.00	10

Figure – 319 KIPSWIRL

Kipswirl 319c – 319f – A Kipswirl is executed to **Vertical Position**. The designated *Twist* or *Spin* is executed.

Note: Refer to Section BM 12 Twists & Twist Allowances and Section BM 13 Spins & Spin Allowances.

Figure – 319d KIPSWIRL SPINNING 180°

DIFFICULTY – 1.7







						Total
NVT=	3.0	2.0	25.0	16.0	0	46
PV =	0.65	0.43	5.43	3.48	0	10

Figure – 319e KIPSWIRL SPINNING 360°

DIFFICULTY – 1.8







						Total
NVT=	3.0	2.0	25.0	19.0	0	49
PV =	0.61	0.41	5.10	3.88	0	10

Figure – 319f KIPSWIRL CONTINUOUS SPIN (720°)

DIFFICULTY – 2.0






					Total
NVT=	3.0	2.0	25.0	34.0	64
PV =	0.47	0.31	3.91	5.31	10

Figure – 320 KIPSWIRL SPLIT CLOSING 180°

DIFFICULTY – 2.3

From a **Back Layout Position** the knees, shins and toes are drawn along the surface of the water to assume a **Tuck Position**. With continuous motion the tuck becomes more compact and a partial Somersault Back Tuck is executed until the shins are perpendicular to the surface of the water. As the trunk unrolls and the legs are straightened a 360° rotation is executed to assume a **Vertical Position**. The legs are lowered symmetrically to a **Split Position**. A rapid rotation of 180° is executed as the legs symmetrically close to a **Vertical Position**. A *Vertical Descent* is executed.








							Total
NVT=	3.0	2.0	25.0	17.0	18.0	14.0	79
PV =	0.38	0.25	3.16	2.15	2.28	1.77	10

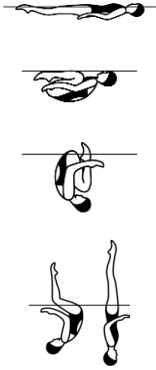

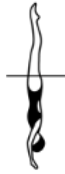

Figure Description	NVT	Diagrams	Major Desired Actions
<p>1. From a Back Layout Position the knees, shins and toes are drawn along the surface of the water to assume a Tuck Position. With continuous motion the tuck becomes more compact and a partial Somersault Back Tuck is executed until the shins are perpendicular to the surface of the water.</p> <p>2. As the trunk unrolls and the legs are straightened a 360° rotation is executed to assume a Vertical Position.</p>	3.0 2.0 25.0		1. See Figure 319, Kipswirl steps 1 - 2.
<p>3. The legs are lowered symmetrically to a Split Position.</p>	17.0		3. See BP 16a Surface Split Position . Both legs remain equidistant from the surface of the water at all times. Height remains constant.

Figure – 320 KIPSWIRL SPLIT CLOSING 180° (cont.)

DIFFICULTY – 2.3

Figure Description	NVT	Diagrams	Major Desired Actions
4. A rapid rotation of 180° is executed as the legs symmetrically close to a Vertical Position .	18.0		<p>4.1 A rapid rotation of 180° and a closing action occur simultaneously, with completion of the turn and achievement of BP 6 Vertical Position occurring as the feet join.</p> <p>4.2 Both legs are always equidistant from the surface of the water.</p> <p>4.3 Longitudinal axis is maintained throughout the rotation.</p> <p>4.4 Height remains constant throughout the rotation.</p>
5. A <i>Vertical Descent</i> is executed.	14.0		<p>5. See BP 6 Vertical Position and BM 10 <i>Vertical Descent</i>. Tempo of the descent is uniform and at the same speed as the root figure.</p>

See Figure 319 Kipswirl for **Back Layout Position, Tuck Position, Vertical Position** and *Vertical Descent Basic Movement*.

BP 16 Split Position



Body Position Description	Diagrams	Major Desired Actions
<p>1. Legs evenly split forward and back.</p> <p>2. The legs are parallel to the surface of the water.</p> <p>3. Lower back arched, with hips, shoulders and head on a vertical line.</p> <p>4. 180° angle between the extended legs (flat split), with inside of each leg aligned on opposite sides of a horizontal line, regardless of the height of the hips.</p> <p>a) Surface Split Position</p> <p>1. Legs are dry at the surface of the water.</p>	 	<p>1. Full extension of the legs at or above the surface of the water.</p> <p>4. Flat split. Hip joints and shoulder joints on a horizontal line, with both of these alignments 'square' and parallel to each other.</p> <p>1. Full extension of the legs. Crotch and legs dry at the surface of the water.</p>

Figure – 321 KIPSWIRL SPLIT CLOSING 360°
DIFFICULTY – 2.5

From a **Back Layout Position** the knees, shins and toes are drawn along the surface of the water to assume a **Tuck Position**. With continuous motion the tuck becomes more compact and a partial Somersault Back Tuck is executed until the shins are perpendicular to the surface of the water. As the trunk unrolls and the legs are straightened a 360° rotation is executed to assume a **Vertical Position**. The legs are lowered symmetrically to a **Split Position**. A rapid rotation of 360° is executed as the legs close symmetrically to a **Vertical Position**. A *Vertical Descent* is executed.








							Total
NVT=	3.0	2.0	25.0	17.0	29.0	14.0	90
PV =	0.33	0.22	2.78	1.89	3.22	1.56	10






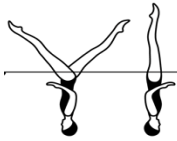

Figure Description	NVT	Diagrams	Major Desired Actions
<p>1. From a Back Layout Position the knees, shins and toes are drawn along the surface of the water to assume a Tuck Position. With continuous motion the tuck becomes more compact and a partial Somersault Back Tuck is executed until the shins are perpendicular to the surface of the water.</p>	3.0		1. See Figure 319, Kipswirl steps 1 - 2.
	2.0		
	25.0		
<p>2. As the trunk unrolls and the legs are straightened a 360° rotation is executed to assume a Vertical Position.</p>			

Figure – 321 KIPSWIRL SPLIT CLOSING 360° (cont.)

DIFFICULTY – 2.5

Figure Description	NVT	Diagrams	Major Desired Actions
3. The legs are lowered symmetrically to a Split Position .	17.0		3. See BP 16a Surface Split Position . Both legs remain equidistant from the surface of the water at all times. Height remains constant.
4. A rapid rotation of 360° is executed as the legs close symmetrically to a Vertical Position .	29.0		4.1 A rapid rotation of 360° and a closing action of the legs occur simultaneously, with completion of the rotation and achievement of BP 6 Vertical Position occurring as the feet join. 4.2 Both legs are always equidistant from the surface of the water. 4.3 Longitudinal axis is maintained throughout the rotation. 4.4 Height remains constant throughout the rotation.
5. A <i>Vertical Descent</i> is executed.	14.0		5. See BP 6 Vertical Position and BM 10 <i>Vertical Descent</i> . Tempo of the descent is uniform and at the same speed as the start of the figure to the Split Position .

See Figure 319 Kipswirl for **Back Layout Position, Tuck Position, Vertical Position** and *Vertical Descent Basic Movement*. See Figure 320 Kip Split Closing 180° for **Split Position**.

Figure – 322 ELEVATOR

DIFFICULTY – 2.5

From a **Back Layout Position** the knees, shins and toes are drawn along the surface of the water to assume a **Tuck Position**. With continuous motion the tuck becomes more compact and a partial Somersault Back Tuck is executed until the shins are perpendicular to the surface of the water. The trunk unrolls as the legs are straightened to assume a **Vertical Position** midway between the former vertical line through the hips and the former vertical line through the head and shins. A water level is established between the knees and the ankles. The trunk rises to assume a **Submerged Ballet Leg Double Position**. Maintaining this position the body rises to a **Surface Ballet Leg Double Position**. Without movement of the thighs a **Tub Position** is assumed. The legs are straightened to resume a **Back Layout Position**.






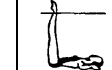



									Total
NVT=	3.0	2.0	23.0	14.0	10.0	16.0	19.0	3.0	90
PV =	0.33	0.22	2.56	1.56	1.11	1.78	2.11	0.33	10

Figure Description	NVT	Diagrams	Major Desired Actions
--------------------	-----	----------	-----------------------

1. From a **Back Layout Position** the knees, shins and toes are drawn along the surface of the water to assume a **Tuck Position**. With continuous motion the tuck becomes more compact and a partial Somersault Back Tuck is executed until the shins are perpendicular to the surface of the water.

3.0



2.0

1.1 See BP 1 **Back Layout** and BP 9 **Tuck Positions**. With the head and shoulders remaining stationary, the knees, shins and toes are drawn to the body to assume a tight tuck at the position occupied by the trunk in the **Back Layout Position**.
1.2 There is continuous motion from the initiation of the knee draw to achievement of the inverted BP 9 **Tuck Position**.

2. The trunk unrolls as the legs are straightened to assume a **Vertical Position** midway between the former vertical line through the hips and the former vertical line through the head and shins.


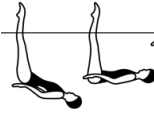



23.0



2.1 BP 6 **Vertical Position** and maximum height achieved simultaneously.
2.2 The **Vertical Position** is held only long enough to define the position and to demonstrate completion of the transition prior to the descent.

Figure – 322 ELEVATOR (cont.)

DIFFICULTY – 2.5

Figure Description	NVT	Diagrams	Major Desired Actions
3. A water level is established between the knees and the ankles.	14.0		3. A BM 10 <i>Vertical Descent</i> is executed until a water level is established between the knees and the ankles. This water level must be maintained through the next transition.
4. The trunk rises to assume a Submerged Ballet Leg Double Position .	10.0		4. Legs remain on the vertical line. Height remains constant. See BP 5b Submerged Ballet Leg Double Position .
5. Maintaining this position the body rises to a Surface Ballet Leg Double Position .	16.0		5.1 See BP 5a. Surface Ballet Leg Double Position held only long enough to define the position and to demonstrate completion of the transition. 5.2 The legs remain on the same vertical line throughout the rise to the surface of the water.
6. Without movement of the thighs a Tub Position is assumed.	19.0		6. The water level and timing remain constant throughout the lowering of the legs from BP 5a Surface Ballet Leg Double Position to Tub Position .
7. The legs are straightened to resume a Back Layout Position .	3.0		7. Full extension and maximum horizontal alignment in BP 1 Back Layout to be achieved simultaneously.

BP 1 Back Layout Position


Body Position Description	Diagrams	Major Desired Actions
1. Body extended with face, chest, thighs and feet at the surface of the water.		1. Gives the impression that the body is stretched horizontally to its maximum. Front of the trunk will also be at the surface of the water.




Figure – 322 ELEVATOR (cont.)

DIFFICULTY – 2.5

BP 1 Back Layout Position (cont.)

Body Position Description	Diagrams	Major Desired Actions
2. Head (ears specifically), hips and ankles in horizontal alignment.		2. Judgement is made by checking visual points of the horizontal alignment: ears, shoulder joints, hip joints and ankles. This imaginary line should also pass through the middle of the side of the trunk.

BP 9 Tuck Position

Body Position Description	Diagrams	Major Desired Actions
1. Body as compact as possible, with the back rounded and the legs together.		1. Legs together with shins at the surface of the water and tucked tightly to the front of the body.
2. Heels close to buttocks.		2. Compact tuck. Chin tucked in.
3. Head close to knees.		3. In BP 9 inverted Tuck Position , shins are perpendicular to the surface of the water, buttocks remain at the surface and the water level is between the ankle and mid foot.

BP 6 Vertical Position


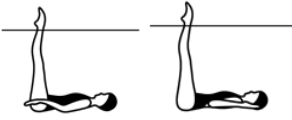

Body Position Description	Diagrams	Major Desired Actions
1. Body extended perpendicular to the surface of the water; legs together, head downward.		1. Full extension of the body.
2. Head (ears specifically), hips and ankles in line.		2. Judgement is made by checking visual points of the vertical alignment: ears, shoulder joints, hip joints and ankles.

Figure – 322 ELEVATOR (cont.)

DIFFICULTY – 2.5

BP 5 Ballet Leg Double Position

Body Position Description	Diagrams	Major Desired Actions
<p>b) Submerged</p> <ol style="list-style-type: none"> 1. Trunk and head parallel to the surface of the water. 2. 90° angle between the trunk and the extended legs. 3. Water level between knees and ankles of the extended legs. 		<ol style="list-style-type: none"> 1. Ears, shoulder joints and hip joints aligned. 2. Legs perpendicular to the surface of the water. Body extended horizontally at 90° angle to the surface of the water.
<p>a) Surface</p> <ol style="list-style-type: none"> 1. Legs together and extended perpendicular to the surface of the water. 		<ol style="list-style-type: none"> 1. Full extension of the legs at a 90° angle to the surface of the water.
<ol style="list-style-type: none"> 2. Head in line with the trunk. 3. Face at the surface of the water. 		<ol style="list-style-type: none"> 2. Chest close to the surface of the water with the shoulders back. Ears, hip joints and shoulder joints aligned, with the spine straight and extended.

BP 15 Tub Position


Body Position Description	Diagrams	Major Desired Actions
<ol style="list-style-type: none"> 1. Legs bent and together, feet and shins at and parallel to the surface of the water with thighs perpendicular. 		<ol style="list-style-type: none"> 1. Knee and hip joints aligned vertically. Legs dry from toes to knees.
<ol style="list-style-type: none"> 2. Head in line with trunk. 3. Face at the surface of the water. 		<ol style="list-style-type: none"> 2. Chest close to the surface of the water, with the shoulders back. Ears, shoulder joints and hip joints aligned, with the spine extended.

Figure – 323 SOMERSAULT FRONT PIKE
DIFFICULTY – 1.4

From a **Front Layout Position** a *Front Pike Position* is assumed. With continuous motion the body somersaults around a lateral axis so that the hips replace the head at each quarter point of the revolution until the head and buttocks return to the surface of the water. As the legs are raised to the surface of the water to assume a **Front Layout Position**, the head, back and buttocks travel along the surface of the water until the hips occupy the same position as the head at the beginning of this action.


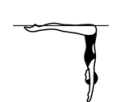



					Total
NVT=	6.0	8.0	8.0	6.0	28
PV =	2.14	2.86	2.86	2.14	10

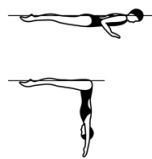
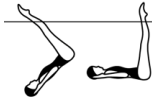



Figure Description	NVT	Diagrams	Major Desired Actions
1. From a Front Layout Position a <i>Front Pike Position</i> is assumed.	6.0		1. See BM 3 To Assume A <i>Front Pike Position</i> .
2. With continuous motion the body somersaults around a lateral axis so that the hips replace the head at each quarter point of the revolution until the head and buttocks return to the surface of the water.	8.0		2. See BM 4 To Assume a <i>Submerged Ballet Leg Double Position From A Front Pike Position</i> . Uniform motion with no pauses at each corner of the 'box' during the rotation.
	8.0		Constant 90° angle maintained throughout.
3. As the legs are raised to the surface of the water to assume a Front Layout Position , the head, back and buttocks travel along the surface of the water until the hips occupy the same position as the head at the beginning of this action.	6.0		3. Simultaneous leg lift and trunk travel with heels surfacing as BP 2 Front Layout Position is achieved. Face remains in the water until the heels reach the surface of the water.

Figure – 323 SOMERSAULT FRONT PIKE

DIFFICULTY – 1.4

BP 2 Front Layout Position

Body Position Description	Diagrams	Major Desired Actions
<p>1. Body extended with head, upper back, buttocks and heels at the surface of the water.</p>		<p>1. Gives the impression that the body is stretched horizontally to its maximum. Judgement made by checking visual points of the horizontal alignment: ears, shoulder joints, hip joints and heels.</p>
<p>2. Unless otherwise specified, face may be in or out of the water.</p>		<p>2. Once the head position is established as in or out of the water the position is maintained. When the face is out of the water the ears will not be on the horizontal axis and the back may be slightly lower and arched. Hip joints, calves and heels remain at the surface of the water.</p>

BP 10 Front Pike Position


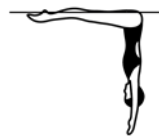
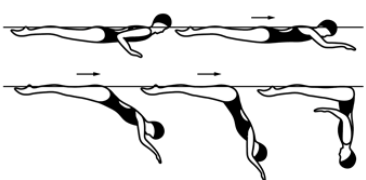
Body Position Description	Diagrams	Major Desired Actions
<p>1. Body bent at hips to form a 90° angle.</p>		<p>1. Exact 90° angle.</p>
<p>2. Legs extended and together.</p>		<p>2. Full extension of legs, with ankles aligned with hip joints.</p>
<p>3. Trunk extended with the back straight and head in line.</p>		<p>3. Back flat, with vertical alignment of ears, shoulder joints and hip joints once the position is established.</p>

Figure – 323 SOMERSAULT FRONT PIKE

DIFFICULTY – 1.4

BM 3 To Assume a Front Pike Position

Basic Movement Description	NVT	Diagrams	Major Desired Actions
<p>1. From a Front Layout Position with the face in the water the trunk moves downward to assume a Front Pike Position. The buttocks, legs and feet travel along the surface of the water until the hips occupy the position of the head at the beginning of this action.</p>	6.0		<p>1.1 See BP 2 Front Layout Position and BP 10 Front Pike Position. Uniform motion in downward movement of the trunk. The trunk remains straight throughout the movement. Hips and head lock into position simultaneously.</p> <p>1.2 Unless otherwise specified, <i>To Assume a Front Pike Position</i> starts from a Front Layout Position.</p>

BM 4 To Assume a Submerged Ballet Leg Double Position From A Front Pike Position

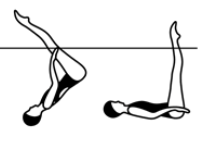
Basic Movement Description	NVT	Diagrams	Major Desired Actions
<p>1. While maintaining a Front Pike Position the body somersaults forward around a lateral axis as the buttocks, legs and feet move downward. The hips replace the head to assume a Submerged Ballet Leg Double Position.</p>	8.0		<p>1.1 See BP 10 Front Pike Position and BP 5b Submerged Ballet Leg Double Position. 90° angle between the trunk and the legs maintained throughout rotation.</p> <p>1.2 Body alignment and extension maintained throughout.</p>

Figure – 324 SOMERSUB
DIFFICULTY – 1.9

From a **Front Layout Position** a Somersault Front Pike is executed to a **Submerged Ballet Leg Double Position**. One leg is lowered to a **Submerged Ballet Leg Position**. Maintaining this position the body rises vertically to a **Surface Ballet Leg Position**. The *Ballet Leg is lowered*.



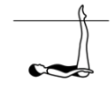
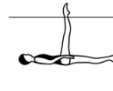
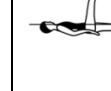
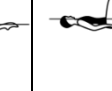
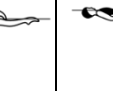
							Total
NVT=	6.0	8.0	8.0	13.5	11.0	10.5	57
PV =	1.05	1.40	1.40	2.37	1.93	1.84	10



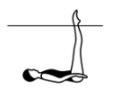



Figure Description	NVT	Diagrams	Major Desired Actions
1. From a Front Layout Position a Somersault Front Pike is executed to a Submerged Ballet Leg Double Position .	6.0	 	1. See BP 2 Front Layout Position , BP 10 Front Pike Position , BP 5b Submerged Ballet Leg Double Position , BM 3 <i>To Assume A Front Pike Position</i> and BM 4 <i>To Assume a Submerged Ballet Leg Double Position From A Front Pike Position</i> . Smooth even movement downwards of the trunk.
2. One leg is lowered to a Submerged Ballet Leg Position .	8.0		2.1 The water level on the vertical leg remains constant as the other leg is lowered to assume BP 3b Submerged Ballet Leg Position . The position must be clearly defined before the body begins to rise. 2.2 The body and the extended leg remain on the same horizontal plane throughout.
3. Maintaining this position the body rises vertically to a Surface Ballet Leg Position .	13.5		3. See BP 3a Surface Ballet Leg Position The body rises along the vertical line established by the submerged ballet leg. The face and the foot of the horizontal leg surface simultaneously.

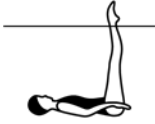
Figure – 324 SOMERSUB (cont.)

DIFFICULTY – 1.9

Figure Description	NVT	Diagrams	Major Desired Actions
4. The <i>Ballet Leg</i> is lowered	11.0		4. See BM 2 To Lower A <i>Ballet Leg</i>
	10.5		

See Figure 323 Somersault Front Pike for **Front Layout Position, Front Pike Position, To Assume A Front Pike Basic Movement, To Assume a Submerged Ballet Leg Double Position From A Front Pike Position Basic Movement.**

BP 5 Ballet Leg Double Position

Body Position Description	Diagrams	Major Desired Actions
<p>b) Submerged</p> <ol style="list-style-type: none"> 1. Trunk and head parallel to the surface of the water. 2. 90° angle between the trunk and the extended legs. 3. Water level between knees and ankles of the extended legs. 		<ol style="list-style-type: none"> 1. Ears, shoulder joints and hip joints aligned. 2. Legs perpendicular to the surface of the water. Body extended horizontally at 90° angle to the surface of the water.

BP 3 Ballet Leg Position




Body Position Description	Diagrams	Major Desired Actions
<p>b) Submerged</p> <ol style="list-style-type: none"> 1. Head, trunk and horizontal leg parallel to the surface of the water. 2. One leg perpendicular to the surface of the water with the water level between the knee and the ankle. 		<ol style="list-style-type: none"> 1. See body alignment requirements of BP 1 Back Layout Position. 2. The angles between the ballet leg and the body must remain at 90° throughout.
<p>a) Surface</p> <ol style="list-style-type: none"> 1. Body in Back Layout Position. 		<ol style="list-style-type: none"> 1. See BP 1 Back Layout Position. Ears, shoulder joints, hip joints and ankle of extended leg in line at maximum horizontal alignment.

Figure – 324 SOMERSUB (cont.)

DIFFICULTY – 1.9

Body Position Description	Diagrams	Major Desired Actions
BP 3 Ballet Leg Position (cont.)		
<p>a) Surface (cont.)</p> <p>2. One leg extended perpendicular to the surface of the water.</p>		<p>2. 90° angle between the extended leg and the surface of the water and between the extended leg and the trunk with maximum horizontal alignment maintained throughout.</p>

BP 14 Bent Knee Position

Body Position Description	Diagrams	Major Desired Actions
<p>One leg bent with the toe of the bent leg in contact with the inside of the extended leg at the knee or higher.</p>		<p>The relationship of the toe of the bent leg to the extended leg may vary depending on the figure but should remain constant once established, and not extend in front of or behind the extended leg.</p>
b) Bent Knee Back Layout Position		
<p>1. Body extended in Back Layout Position.</p>		<p>1. In BP 1 Back Layout Position ears, shoulder joints, hip joints and ankle of extended leg in line at maximum horizontal alignment.</p>
<p>2. The thigh of the bent leg is perpendicular to the surface of the water.</p>		<p>2. 90° angle between the thigh and the surface of the water, and 90° angle maintained between the thigh and the trunk. At maximum height an air pocket will be evident between the back of the thigh and calf of the bent leg and the surface of the water.</p>

BM 2 To Lower a Ballet Leg




Basic Movement Description	NVT	Diagrams	Major Desired Actions
<p>1. From a Ballet Leg Position the ballet leg is bent without movement of the thigh to a Bent Knee Back Layout Position.</p>			<p>1. See BP 3a Surface Ballet Leg Position and BP 14b Bent Knee Back Layout Position. The height remains constant throughout the movement.</p>
<p>2. The toe moves along the inside of the extended leg until a Back Layout Position is assumed.</p>	11.0		<p>2.1 Full extension in BP 1 Back Layout Position to be achieved as the feet are joined.</p>
	10.5		<p>2.2 The head and trunk remain stationary throughout.</p>

Figure – 325 SUBALINA

DIFFICULTY – 2.2

From a **Front Layout Position** a Somersault Front Pike is executed to a **Submerged Ballet Leg Double Position**. One leg is lowered to a **Submerged Ballet Leg Position**. As the body rises a *Catalina Rotation* is executed to a **Fishtail Position**. The horizontal leg is lifted to **Vertical Position**. A *Vertical Descent* is executed.








							Total
NVT=	6.0	8.0	8.0	14.5	20.5	14.0	71
PV =	0.85	1.13	1.13	2.04	2.89	1.97	10





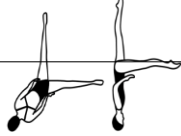



Figure Description	NVT	Diagrams	Major Desired Actions
1. From a Front Layout Position a Somersault Front Pike is executed to a Submerged Ballet Leg Double Position .	6.0		1. See Figure 324 Somersub step 1.
			
	8.0		
2. One leg is lowered to a Submerged Ballet Leg Position .	8.0		2. See Figure 324 Somersub step 2.
3. As the body rises a <i>Catalina Rotation</i> is executed to a Fishtail Position .	14.5		3.1 See BM 7 <i>Catalina Rotation</i> . The initiation of the rotation and the body rise occur simultaneously. 3.2 Completion of the rotation, establishment of maximum height and achievement of BP 8 Fishtail Position occur simultaneously.

Figure – 325 SUBALINA (cont.)

DIFFICULTY – 2.2

Figure Description	NVT	Diagrams	Major Desired Actions
4. The horizontal leg is lifted to Vertical Position .	20.5		4.1 See BP 6 Vertical Position . Height is constant as the legs join, with the trunk and the vertical leg maintaining vertical alignment. 4.2 The Vertical Position is held only long enough to define the position and to demonstrate completion of the transition prior to the descent.
5. A <i>Vertical Descent</i> is executed.	14.0		5. See BM 10 <i>Vertical Descent</i> .

BP 2 Front Layout Position

Body Position Description	Diagrams	Major Desired Actions
1. Body extended with head, upper back, buttocks and heels at the surface of the water.		1. Gives the impression that the body is stretched horizontally to its maximum. Judgement made by checking visual points of the horizontal alignment: ears, shoulder joints, hip joints and heels.
2. Unless otherwise specified, face may be in or out of the water.		2. Once the head position is established as in or out of the water the position is maintained. When the face is out of the water the ears will not be on the horizontal axis and the back may be slightly lower and arched. Hip joints, calves and heels remain at the surface of the water.

BP 10 Front Pike Position


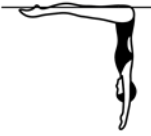
Body Position Description	Diagrams	Major Desired Actions
1. Body bent at hips to form a 90° angle.		1. Exact 90° angle.

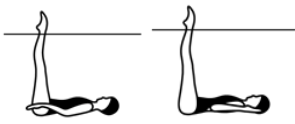
Figure – 325 SUBALINA (cont.)

DIFFICULTY – 2.2

BP 10 Front Pike Position (cont.)

Body Position Description	Diagrams	Major Desired Actions
2. Legs extended and together.		2. Full extension of legs, with ankles aligned with hip joints.
3. Trunk extended with the back straight and head in line.		3. Back flat, with vertical alignment of ears, shoulder joints and hip joints once the position is established.

BP 5 Ballet Leg Double Position

Body Position Description	Diagrams	Major Desired Actions
b) Submerged		
1. Trunk and head parallel to the surface of the water.		1. Ears, shoulder joints and hip joints aligned.
2. 90° angle between the trunk and the extended legs.		2. Legs perpendicular to the surface of the water. Body extended horizontally at 90° angle to the surface of the water.
3. Water level between knees and ankles of the extended legs.		

BP 3 Ballet Leg Position

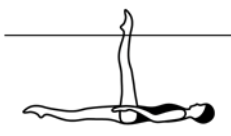

Body Position Description	Diagrams	Major Desired Actions
b) Submerged		
1. Head, trunk and horizontal leg parallel to the surface of the water.		1. See body alignment requirements of BP 1 Back Layout Position .
2. One leg perpendicular to the surface of the water with the water level between the knee and the ankle.		2. The angles between the ballet leg and the body must remain at 90° throughout.


Figure – 325 SUBALINA (cont.)

DIFFICULTY – 2.2

BP 8 Fishtail Position

Body Position Description	Diagrams	Major Desired Actions
1. Body extended in Vertical Position with one leg extended forward. The foot of the forward leg is at the surface of the water regardless of the height of the hips.		1. See BP 6 Vertical Position for body alignment. The foot of the forward leg must be at the surface of the water. Hip joints must be on a horizontal line.

BP 6 Vertical Position

Body Position Description	Diagrams	Major Desired Actions
1. Body extended perpendicular to the surface of the water; legs together, head downward.		1. Full extension of the body.
2. Head (ears specifically), hips and ankles in line.		2. Judgement is made by checking visual points of the vertical alignment: ears, shoulder joints, hip joints and ankles.

BM 3 To Assume a Front Pike Position

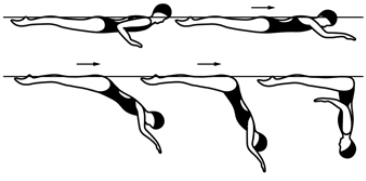
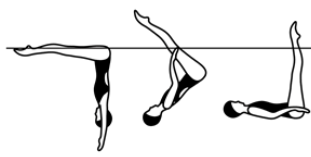
Basic Movement Description	NVT	Diagrams	Major Desired Actions
1. From a Front Layout Position with the face in the water the trunk moves downward to assume a Front Pike Position . The buttocks, legs and feet travel along the surface of the water until the hips occupy the position of the head at the beginning of this action.	6.0		1.1 See BP 2 Front Layout Position and BP 10 Front Pike Position . Uniform motion in downward movement of the trunk. The trunk remains straight throughout the movement. Hips and head lock into position simultaneously. 1.2 Unless otherwise specified, <i>To Assume a Front Pike Position</i> starts from a Front Layout Position .

Figure – 325 SUBALINA (cont.)

DIFFICULTY – 2.2

BM 4 To Assume a Submerged Ballet Leg Double Position From A Front Pike Position

Basic Movement Description	NVT	Diagrams	Major Desired Actions
<p>1. While maintaining a Front Pike Position the body somersaults forward around a lateral axis as the buttocks, legs and feet move downward. The hips replace the head to assume a Submerged Ballet Leg Double Position.</p>	8.0		<p>1.1 See BP 10 Front Pike Position and BP 5b Submerged Ballet Leg Double Position. 90° angle between the trunk and the legs maintained throughout rotation.</p> <p>1.2 Body alignment and extension maintained throughout.</p>

BM 7 Catalina Rotation - from a submerged Ballet Leg to Fishtail Position

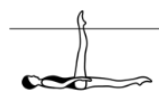
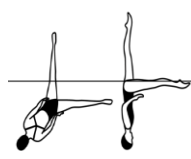

Basic Movement Description	NVT	Diagrams	Major Desired Actions
<p>1. From a Submerged Ballet Leg Position as the body rises a <i>Catalina Rotation</i> is executed to a Fishtail Position.</p>			<p>1. See BP 3b Submerged Ballet Leg Position.</p>
<p>2. The head, shoulders and trunk begin the rotation without lateral movement to a Fishtail Position.</p>	14.5		<p>2.1 Simultaneous rotation and ascent of the trunk along the vertical line established by the vertical leg.</p> <p>2.2 At the halfway point, the body is in a tilted 'Y' position, with the trunk at a 45° angle to the surface of the water, and the head, trunk and legs face forward.</p> <p>2.3 Completion of the rotation, establishment of maximum height and achievement of BP 8 Fishtail Position occur simultaneously.</p> <p>2.4 See BP 8 Fishtail Position.</p>
<p>3. The vertical leg remains perpendicular to the surface of the water while the horizontal leg remains at a 90° angle throughout the rotation until assuming a Fishtail Position. In the Fishtail Position the foot of the forward leg is at the surface of the water regardless of the height of the hips.</p>			<p>3. Each leg rotates around its respective horizontal or vertical axis, simultaneously throughout the rotation of the descending trunk.</p>

Figure – 325 SUBALINA (cont.)
DIFFICULTY – 2.2
BM 10 Vertical Descent

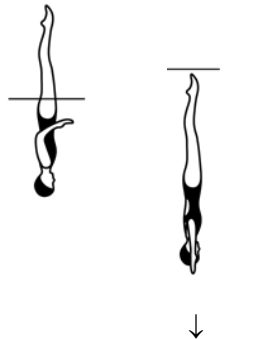
Basic Movement Description	NVT	Diagrams	Major Desired Actions
1. Maintaining a Vertical Position the body descends along its longitudinal axis until the toes are submerged.	14.0		1. See BP 6 Vertical Position . The tempo of the descent is uniform and at the same speed as the rest of the figure.

Figure – 326 SUBILARC
DIFFICULTY – 2.8

From a **Front Layout Position** a Somersault Front Pike is executed to a **Submerged Ballet Leg Double Position**. One leg is lowered to a **Submerged Ballet Leg Position**. As the body rises a *Catalina Rotation* is executed to a **Fishtail Position**. The horizontal leg is lifted in a 180° arc over the surface of the water. As it passes the vertical leg, the vertical leg moves symmetrically in the opposite direction, and the legs assume a **Split Position** simultaneously. A *Walkout Front* is executed.



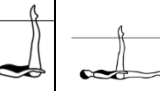



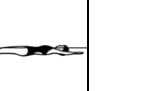

									Total
NVT=	6.0	8.0	8.0	14.5	20.5	17.0	23.0	7.0	104
PV =	0.58	0.77	0.77	1.39	1.97	1.63	2.21	0.67	10



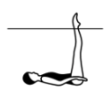
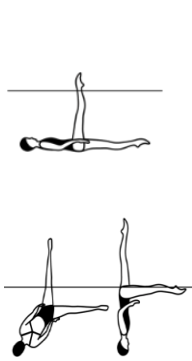
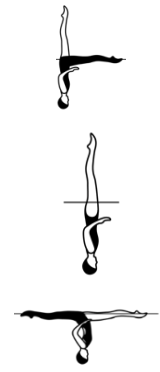
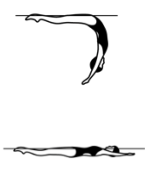
Figure Description	NVT	Diagrams	Major Desired Actions
1. From a Front Layout Position a Somersault Front Pike is executed to a Submerged Ballet Leg Double Position .	6.0	 	1. See Figure 324 Somersub step 1.
2. One leg is lowered to a Submerged Ballet Leg Position .	8.0		2. See Figure 324 Somersub step 2.
3. As the body rises a <i>Catalina Rotation</i> is executed to a Fishtail Position .	14.5		3. See BM 7 <i>Catalina Rotation</i> . The initiation of the rotation and the body rise occur simultaneously. Completion of the rotation, establishment of maximum height and achievement of BP 8 Fishtail Position occur simultaneously.

Figure – 326 SUBILARC (cont.)

DIFFICULTY – 2.8

Figure Description	NVT	Diagrams	Major Desired Actions
<p>4. The horizontal leg is lifted in a 180° arc over the surface of the water. As it passes the vertical leg, the vertical leg moves symmetrically in the opposite direction, and the legs assume a Split Position simultaneously.</p> <p>It is important to note that the horizontal leg in the Fishtail Position must become the back leg in the Split Position.</p> <p>The diagram shows the Fishtail Position to Split Position movement performed with the left (L) leg shaded black however either leg can be used to perform the action.</p>	<p>20.5</p> <p>17.0</p>		<p>4.1 From BP 8 Fishtail Position, height maintained on lift and pass through of the leg. Arcing leg moves continuously at a uniform speed with no pause as the legs pass the vertical prior to lowering of the legs to BP 16a Surface Split Position.</p> <p>4.2 Both legs are always equidistant from the surface of the water and reach the surface of the water simultaneously.</p> <p>4.3 The lifted leg becomes the back leg in the Split Position.</p>
<p>5. A <i>Walkout Front</i> is executed.</p>	<p>23.0</p> <p>7.0</p>		<p>5. See BM 6a <i>Walkout Front</i> and see BM 5 <i>Arch to Back Layout Position</i>.</p>

See Figure 325 Subalina for **Front Layout Position, Front Pike, Ballet Leg Double Submerged Position, Ballet Leg Single Submerged Position, Fishtail Position, Vertical Position, To Assume A Front Pike Position Basic Movement, To Assume a Submerged Ballet Leg Double Position From A Front Pike Position Basic Movement and Catalina Rotation from a Submerged Ballet Leg Basic Movement.**

BP 16 Split Position

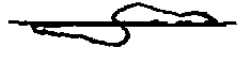


Body Position Description	Diagrams	Major Desired Actions
<p>1. Legs evenly split forward and back.</p> <p>2. The legs are parallel to the surface of the water.</p> <p>3. Lower back arched, with hips, shoulders and head on a vertical line.</p> <p>4. 180° angle between the extended legs (flat split), with inside of each leg aligned on opposite sides of a horizontal line, regardless of the height of the hips.</p>		<p>1. Full extension of the legs at or above the surface of the water.</p> <p>4. Flat split. Hip joints and shoulder joints on a horizontal line, with both of these alignments 'square' and parallel to each other.</p>

Figure – 326 SUBILARC (cont.)
DIFFICULTY – 2.8

Body Position Description	Diagrams	Major Desired Actions
a) Surface Split Position 1. Legs are dry at the surface of the water.		1. Full extension of the legs. Crotch and legs dry at the surface of the water.

BP 13 Surface Arch Position

Body Position Description	Diagrams	Major Desired Actions
1. Lower back arched with hips, shoulders and head on a vertical line.		1. Hip joints and shoulder joints on a horizontal line with both of these alignments 'square' and parallel to one another. Head (ears specifically) in line with shoulders.
2. Legs together and at the surface of the water.		2. Hips joints at the surface of the water.

BM 6 Walkouts


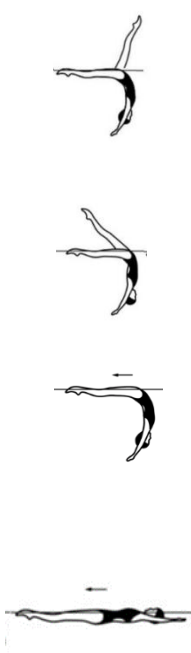
Basic Movement Description	NVT	Diagrams	Major Desired Actions
1. These movements start in a Split Position unless otherwise specified in the figure description. The hips remain stationary as one leg is lifted in an arc over the surface of the water to meet the opposite leg.			1. See BP 16a Surface Split Position .

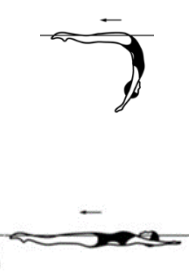
Figure – 326 SUBILARC (cont.)

DIFFICULTY – 2.8

BM 6 Walkouts (cont.)

Basic Movement Description	NVT	Diagrams	Major Desired Actions
<p>a) Walkout Front</p> <p>2. The front leg is lifted in a 180° arc over the surface of the water to meet the opposite leg in a Surface Arch Position and with continuous movement an <i>Arch to Back Layout Finish Action</i> is executed.</p>	<p>23.0</p> <p>7.0</p>		<p>2.1 Hip height remains constant and at the surface of the water.</p> <p>2.2 Arcing leg moves continuously with uniform motion.</p> <p>2.3 Both legs maintain full extension.</p> <p>2.4 The trunk remains stationary until the feet join.</p> <p>2.5 No pause in BP 13 Surface Arch Position, however an accurate surface arch must be evident before the body begins to rise and straighten.</p> <p>2.6 Foot first surfacing motion begins when the feet are joined.</p> <p>2.7 See BP 13 Surface Arch Position and BM 5 <i>Arch to Back Layout Finish Action</i>.</p>

BM 5 Arch to Back Layout Finish Action

Basic Movement Description	NVT	Diagrams	Major Desired Actions
<p>1. From a Surface Arch Position the hips, chest and face surface sequentially at the same point with foot first movement to a Back Layout Position until the head occupies the position of the hips at the beginning of this action.</p>	<p>7.0</p>		<p>1. See BP 13 Surface Arch Position. Sharp arch in the lower back. The body rises, straightens and moves along the surface of the water with a stationary BP 1 Back Layout Position achieved as the face surfaces. Full extension maintained throughout.</p>



Artistic Swimming Figures Manual

2022 – 2025

Part 2

Category III b

Figure – 327 BALLERINA

DIFFICULTY – 1.8

From a **Front Layout Position** a Somersault Front Pike is executed to a **Submerged Ballet Leg Double Position**. One leg is bent to assume a **Submerged Flamingo Position**. Maintaining the position of the legs the body rises to a **Surface Flamingo Position**. The ballet leg is lowered in a 90° arc to the surface of the water as the other leg moves to assume a **Bent Knee Back Layout Position**. The toe of the bent leg moves along the inside of the extended leg until a **Back Layout Position** is assumed.



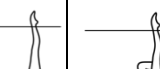



							Total
NVT=	6.0	8.0	3.0	10.0	15.0	10.5	52.5
PV =	1.14	1.52	0.57	1.90	2.86	2.00	10


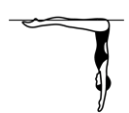
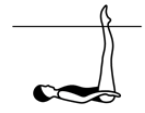
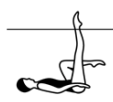



Figure Description	NVT	Diagrams	Major Desired Actions
1. From a Front Layout Position a Somersault Front Pike is executed to a Submerged Ballet Leg Double Position .			See BP 2 Front Layout Position , BP 10 Front Pike Position , BP 5b Submerged Ballet Leg Double Position , BM 3 <i>To Assume A Front Pike Position</i> and BM 4 <i>To Assume a Submerged Ballet Leg Double Position From A Front Pike Position</i> .
	6.0		
	8.0		Smooth even movement downwards of the trunk.
2. One leg is bent to assume a Submerged Flamingo Position .	3.0		2. See BP 4b Submerged Flamingo Position . The water level remains constant on the vertical leg throughout the transition.
3. Maintaining the position of the legs position the body rises to a Surface Flamingo Position .	10.0		3. See BP 4a Surface Flamingo Position . Maintaining the vertical line, the face and shin of the bent leg surface simultaneously.

Figure – 327 BALLERINA (cont.)

DIFFICULTY – 1.8

Figure Description	NVT	Diagrams	Major Desired Actions
<p>4. The ballet leg is lowered in a 90° arc to the surface of the water as the other leg moves to assume a Bent Knee Position.</p> <p>It is important to note that the ballet leg must be lowered to the surface of the water as the horizontal leg moves to assume a bent knee in the Bent Knee Back Layout Position.</p> <p>The diagram shows the Flamingo Position to the Bent Knee Back Layout Position movement performed with the right (R) leg shaded black however either leg can be used to perform the action.</p>	15.0		<p>4. See BP14b Bent Knee Back Layout Position and BP 1 Back Layout Position. The thigh of the bent leg achieves the vertical line and maximum height as the foot of the extended leg reaches the surface of the water simultaneously.</p>
<p>5. The toe of the bent leg moves along the inside of the extended leg until a Back Layout Position is assumed.</p>	10.5		<p>5. Full extension and maximum horizontal alignment in BP 1 Back Layout Position to be achieved as the feet are joined.</p>

BP 2 Front Layout Position





Body Position Description	Diagrams	Major Desired Actions
<p>1. Body extended with head, upper back, buttocks and heels at the surface of the water.</p>		<p>1. Gives the impression that the body is stretched horizontally to its maximum. Judgement made by checking visual points of the horizontal alignment: ears, shoulder joints, hip joints and heels.</p>
<p>2. Unless otherwise specified, face may be in or out of the water.</p>		<p>2. Once the head position is established as in or out of the water the position is maintained. When the face is out of the water the ears will not be on the horizontal axis and the back may be slightly lower and arched. Hip joints, calves and heels remain at the surface of the water.</p>

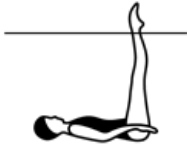
Figure – 327 BALLERINA (cont.)

DIFFICULTY – 1.8

BP 10 Front Pike Position

Body Position Description	Diagrams	Major Desired Actions
1. Body bent at hips to form a 90° angle.		1. Exact 90° angle.
2. Legs extended and together.		2. Full extension of legs, with ankles aligned with hip joints.
3. Trunk extended with the back straight and head in line.		3. Back flat, with vertical alignment of ears, shoulder joints and hip joints once the position is established.

BP 5 Ballet Leg Double Position

Body Position Description	Diagrams	Major Desired Actions
b) Submerged		
1. Trunk and head parallel to the surface of the water.		1. Ears, shoulder joints and hip joints aligned.
2. 90° angle between the trunk and the extended legs.		2. Legs perpendicular to the surface of the water. Body extended horizontally at 90° angle to the surface of the water.
3. Water level between knees and ankles of the extended legs.		

BP 4 Flamingo Position



Body Position Description	Diagrams	Major Desired Actions
b) Submerged		
1. Trunk, head, shin and foot of the bent leg parallel to the surface of the water.		1. Ears, shoulder joints and hip joints aligned.
2. 90° angle between the trunk and extended leg.		2. The vertical leg is extended perpendicular to the bent leg midway between the knee and the ankle of the horizontal leg.
3. Water level between knee and ankle of the extended leg.		

Figure – 327 BALLERINA (cont.)

DIFFICULTY – 1.8

BP 4 Flamingo Position

Body Position Description	Diagrams	Major Desired Actions
<p>a) Surface</p> <p>1. One leg extended perpendicular to the surface of the water.</p> <p>2. The other leg bent with the mid-calf opposite the vertical leg. Foot, shin and knee at and parallel to the surface of the water.</p> <p>3. Face at the surface of the water.</p>		<p>1. 90° angle between the extended leg and the surface of the water.</p> <p>2. The top of the bent leg from knee to toes should be dry with the vertical leg extended perpendicular midway between the knee and ankle of the horizontal leg.</p> <p>3. Chest close to the surface of the water with the shoulders back. Ears, shoulder joints and hip joints aligned with the spine straight and extended.</p>

BP 14 Bent Knee Position



Body Position Description	Diagrams	Major Desired Actions
<p>One leg bent with the toe of the bent leg in contact with the inside of the extended leg at the knee or higher.</p>		<p>The relationship of the toe of the bent leg to the extended leg may vary depending on the figure but should remain constant once established, and not extend in front of or behind the extended leg.</p>
<p>b) Bent Knee Back Layout Position</p> <p>1. Body extended in Back Layout Position.</p> <p>2. The thigh of the bent leg is perpendicular to the surface of the water.</p>		<p>1. In BP 1 Back Layout Position ears, shoulder joints, hip joints and ankle of extended leg in line at maximum horizontal alignment.</p> <p>2. 90° angle between the thigh and the surface of the water, and 90° angle maintained between the thigh and the trunk. At maximum height an air pocket will be evident between the back of the thigh and calf of the bent leg and the surface of the water.</p>

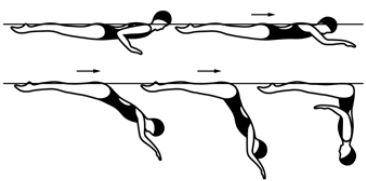
Figure – 327 BALLERINA (cont.)

DIFFICULTY – 1.8

BP 1 Back Layout Position

Body Position Description	Diagrams	Major Desired Actions
<p>1. Body extended with face, chest, thighs and feet at the surface of the water.</p>		<p>1. Gives the impression that the body is stretched horizontally to its maximum. Front of the trunk will also be at the surface of the water.</p>
<p>2. Head (ears specifically), hips and ankles in horizontal alignment.</p>		<p>2. Judgement is made by checking visual points of the horizontal alignment: ears, shoulder joints, hip joints and ankles. This imaginary line should also pass through the middle of the side of the trunk.</p>

BM 3 To Assume a Front Pike Position

Basic Movement Description	NVT	Diagrams	Major Desired Actions
<p>1. From a Front Layout Position with the face in the water the trunk moves downward to assume a Front Pike Position. The buttocks, legs and feet travel along the surface of the water until the hips occupy the position of the head at the beginning of this action.</p>	6.0		<p>1.1 See BP 2 Front Layout Position and BP 10 Front Pike Position. Uniform motion in downward movement of the trunk. The trunk remains straight throughout the movement. Hips and head lock into position simultaneously.</p> <p>1.2 Unless otherwise specified, <i>To Assume a Front Pike Position</i> starts from a Front Layout Position.</p>

BM 4 To Assume a Submerged Ballet Leg Double Position From A Front Pike Position


Basic Movement Description	NVT	Diagrams	Major Desired Actions
<p>1. While maintaining a Front Pike Position the body somersaults forward around a lateral axis as the buttocks, legs and feet move downward. The hips replace the head to assume a Submerged Ballet Leg Double Position.</p>	8.0		<p>1.1 See BP 10 Front Pike Position and BP 5b Submerged Ballet Leg Double Position. 90° angle between the trunk and the legs maintained throughout the rotation.</p> <p>1.2 Body alignment and extension maintained throughout.</p>

Figure – 328 LAGOON

DIFFICULTY – 2.4

From a **Front Layout Position** a Somersault Front Pike is executed to a **Submerged Ballet Leg Double Position**. Maintaining the vertical line of the legs the hips are lifted as the trunk is unrolled to assume a **Vertical Position**. One leg is lowered to a **Knight Position**. The vertical leg is lowered to assume a **Surface Arch Position**. With continuous motion a *Surface Arch to Back Layout Finish Action* is executed.




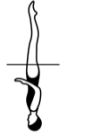



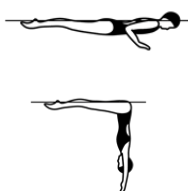
							Total
NVT=	6.0	8.0	19.0	23.5	18.5	7.0	82
PV =	0.73	0.98	2.32	2.87	2.26	0.85	10

Figure Description	NVT	Diagrams	Major Desired Actions
--------------------	-----	----------	-----------------------

1. From a **Front Layout Position** a Somersault Front Pike is executed to a **Submerged Ballet Leg Double Position**.

6.0



8.0



1. See BP 2 **Front Layout Position**, BP 10 **Front Pike Position**, BP 5b **Submerged Ballet Leg Double Position**, BM 3 *To Assume A Front Pike Position* and BM 4 *To Assume a Submerged Ballet Leg Double Position From A Front Pike Position*.
Smooth even movement downwards of the trunk.

2. Maintaining the vertical line of the legs the hips are lifted as the trunk is unrolled to assume a **Vertical Position**.

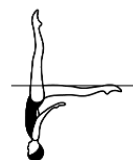
19.0



2. The body unrolls under the legs to assume BP 6 **Vertical Position** in the same perpendicular line established by the legs in the BP 5b **Submerged Ballet Leg Double Position**.

3. One leg is lowered to a **Knight Position**.



23.5



3.1 See BP 17 **Knight Position**. Hip joints and shoulder joints on a horizontal line with both of these alignments 'square' and parallel to each other.
3.2 Height and alignment of legs maintained.
3.3 No movement of the vertical leg and trunk.
3.4 This position is held only long enough to define the Knight Position and to demonstrate completion of the transition.

Figure – 328 LAGOON (cont.)

DIFFICULTY – 2.4

Figure Description	NVT	Diagrams	Major Desired Actions
4. The vertical leg is lowered to assume a Surface Arch Position	18.5		<p>See BP 13 Surface Arch Position.</p> <p>4.1 Hip and shoulder joints remain on a horizontal line.</p> <p>4.2 Hip height remains constant and at the surface of the water.</p> <p>4.3 Both legs maintain full extension.</p> <p>4.4 The trunk remains stationary until the feet join.</p> <p>4.5 No pause in BP 13 Surface Arch Position however an accurate surface arch must be evident before BM 5 <i>Arch to Back Layout Finish Action</i> occurs.</p>
5. With continuous motion a <i>Surface Arch to Back Layout Finish Action</i> is executed	7.0		5. See BM 5 <i>Arch to Back Layout Action</i> .

See Figure 327 Ballerina for **Front Layout Position, Front Pike Position, Submerged Ballet Leg Double Position, To Assume A Front Pike Position Basic Movement** and *To Assume a Submerged Ballet Leg Double Position From A Front Pike Position Basic Movement*.

BP 6 Vertical Position


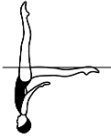
Body Position Description	Diagrams	Major Desired Actions
1. Body extended perpendicular to the surface of the water; legs together, head downward.		1. Full extension of the body.
2. Head (ears specifically), hips and ankles in line.		2. Judgement is made by checking visual points of the vertical alignment: ears, shoulder joints, hip joints and ankles.


Figure – 328 LAGOON (cont.)

DIFFICULTY – 2.4

BP 17 Knight Position

Body Position Description	Diagrams	Major Desired Actions
1. Lower back arched, with hips, shoulders and head on a vertical line.		1. Arch is in the lower part of the spine only.
2. One leg vertical.		2. Vertical alignment through ears, shoulder joints, hip joints and ankle of the vertical leg.
3. Other leg extended backward with the leg at the surface of the water and as close to horizontal as possible.		3. Hip joints and shoulder joints on a horizontal line with both of these alignments 'square' and parallel to each other. The top of the horizontal extended leg faces upward.

BP 13 Surface Arch Position

Body Position Description	Diagrams	Major Desired Actions
1. Lower back arched with hips, shoulders and head on a vertical line.		1. Hip joints and shoulder joints on a horizontal line with both of these alignments 'square' and parallel to one another. Head (ears specifically) in line with shoulders.
2. Legs together and at the surface of the water.		2. Hips joints at the surface of the water.

BM 5 Arch to Back Layout Finish Action


Basic Movement Description	NVT	Diagrams	Major Desired Actions
1. From a Surface Arch Position the hips, chest and face surface sequentially at the same point with foot first movement to a Back Layout Position until the head occupies the position of the hips at the beginning of this action.	7.0		1. See BP 13 Surface Arch Position . Sharp arch in the lower back. The body rises, straightens and moves along the surface of the water with a stationary BP 1 Back Layout Position achieved as the face surfaces. Full extension maintained throughout.

Figure – 330 AURORA

DIFFICULTY – 2.3

From a **Front Layout Position** a Somersault Front Pike is executed to a **Submerged Ballet Leg Double Position**. The trunk and one leg rise vertically as the other leg moves along the surface of the water to assume a **Knight Position**. Maintaining the vertical alignment the body rotates 180° to assume a **Fishtail Position**. The horizontal leg is lifted to **Vertical Position**. A *Vertical Descent* is executed.




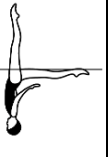

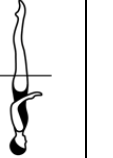
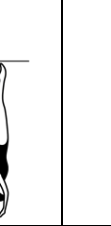
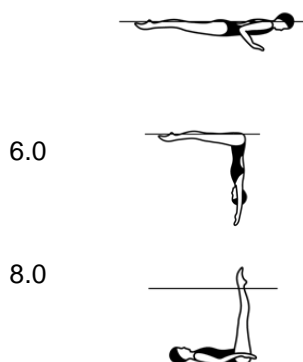
							Total
NVT=	6.0	8.0	16.0	14.0	20.5	14.0	78.5
PV =	0.76	1.02	2.04	1.78	2.61	1.78	10

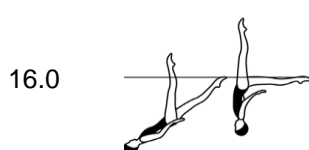
Figure Description	NVT	Diagrams	Major Desired Actions
--------------------	-----	----------	-----------------------

1. From a **Front Layout Position** a Somersault Front Pike is executed to a **Submerged Ballet Leg Double Position**.



1. See BP 2 **Front Layout Position**, BP 10 **Front Pike Position**, BP 5b **Submerged Ballet Leg Double Position**, BM 3 *To Assume A Front Pike Position* and BM 4 *To Assume a Submerged Ballet Leg Double Position From A Front Pike Position*.
Smooth even movement downwards of the trunk.

2. The trunk and one leg rise vertically as the other leg moves along the surface of the water to assume a **Knight Position**.



2.1 The trunk unrolls beneath the vertical leg. Movement of the trunk and the legs to BP 17 **Knight Position** is simultaneous with the rise.
2.2 Maximum height and body alignment in **Knight Position** achieved simultaneously.



3. Maintaining the vertical alignment the body rotates 180° to assume a **Fishtail Position**.





3.1 See BP 8 **Fishtail Position**. Height remains constant during the rotation.
3.2 Trunk, horizontal and vertical leg maintain alignment throughout the rotation.

Figure – 330 AURORA (cont.)

DIFFICULTY – 2.3

Figure Description	NVT	Diagrams	Major Desired Actions
4. The horizontal leg is lifted to Vertical Position .	20.5		4.1 See BP 6 Vertical Position . Height is constant as the legs join, with the trunk and the vertical leg maintaining vertical alignment. 4.2 The Vertical Position is held only long enough to define the position and to demonstrate completion of the transition prior to descent.
5. A <i>Vertical Descent</i> is executed.	14.0		5. See BM 10 <i>Vertical Descent</i> .

BP 2 Front Layout Position

Body Position Description	Diagrams	Major Desired Actions
1. Body extended with head, upper back, buttocks and heels at the surface of the water.		1. Gives the impression that the body is stretched horizontally to its maximum. Judgement made by checking visual points of the horizontal alignment: ears, shoulder joints, hip joints and heels.
2. Unless otherwise specified, face may be in or out of the water.		2. Once the head position is established as in or out of the water the position is maintained. When the face is out of the water the ears will not be on the horizontal axis and the back may be slightly lower and arched. Hip joints, calves and heels remain at the surface of the water.

BP 10 Front Pike Position



Body Position Description	Diagrams	Major Desired Actions
1. Body bent at hips to form a 90° angle.		1. Exact 90° angle.

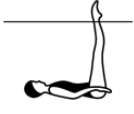
Figure – 330 AURORA (cont.)

DIFFICULTY – 2.3

BP 10 Front Pike Position (cont.)

Body Position Description	Diagrams	Major Desired Actions
2. Legs extended and together.		2. Full extension of legs, with ankles aligned with hip joints.
3. Trunk extended with the back straight and head in line.		3. Back flat, with vertical alignment of ears, shoulder joints and hip joints once the position is established.

BP 5 Ballet Leg Double Position

Body Position Description	Diagrams	Major Desired Actions
b) Submerged		
1. Trunk and head parallel to the surface of the water.		1. Ears, shoulder joints and hip joints aligned.
2. 90° angle between the trunk and the extended legs.		2. Legs perpendicular to the surface of the water. Body extended horizontally at 90° angle to the surface of the water.
3. Water level between knees and ankles of the extended legs.		

BP 17 Knight Position

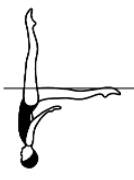
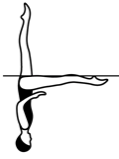
Body Position Description	Diagrams	Major Desired Actions
1. Lower back arched, with hips, shoulders and head on a vertical line.		1. Arch is in the lower part of the spine only.
2. One leg vertical.		2. Vertical alignment through ears, shoulder joints, hip joints and ankle of the vertical leg.
3. Other leg extended backward with the leg at the surface of the water and as close to horizontal as possible.		3. Hip joints and shoulder joints on a horizontal line with both of these alignments 'square' and parallel to each other. The top of the horizontal extended leg faces upward.


Figure – 330 AURORA (cont.)

DIFFICULTY – 2.3

BP 8 Fishtail Position

Body Position Description	Diagrams	Major Desired Actions
1. Body extended in Vertical Position with one leg extended forward. The foot of the forward leg is at the surface of the water regardless of the height of the hips.		1. See BP 6 Vertical Position for body alignment. The foot of the forward leg must be at the surface of the water. Hip joints must be on a horizontal line.

BP 6 Vertical Position

Body Position Description	Diagrams	Major Desired Actions
1. Body extended perpendicular to the surface of the water; legs together, head downward.		1. Full extension of the body.
2. Head (ears specifically), hips and ankles in line.		2. Judgement is made by checking visual points of the vertical alignment: ears, shoulder joints, hip joints and ankles.

BM 3 To Assume a Front Pike Position

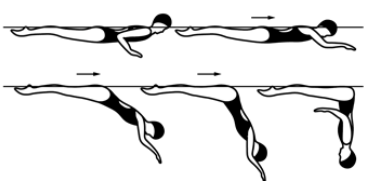
Basic Movement Description	NVT	Diagrams	Major Desired Actions
1. From a Front Layout Position with the face in the water the trunk moves downward to assume a Front Pike Position . The buttocks, legs and feet travel along the surface of the water until the hips occupy the position of the head at the beginning of this action.	6.0		1.1 See BP 2 Front Layout Position and BP 10 Front Pike Position . Uniform motion in downward movement of the trunk. The trunk remains straight throughout the movement. Hips and head lock into position simultaneously. 1.2 Unless otherwise specified, <i>To Assume a Front Pike Position</i> starts from a Front Layout Position .

Figure – 330 AURORA (cont.)

DIFFICULTY – 2.3

BM 4 To Assume a Submerged Ballet Leg Double Position From A Front Pike Position

Basic Movement Description	NVT	Diagrams	Major Desired Actions
<p>1. While maintaining a Front Pike Position the body somersaults forward around a lateral axis as the buttocks, legs and feet move downward. The hips replace the head to assume a Submerged Ballet Leg Double Position.</p>	8.0		<p>1.1 See BP 10 Front Pike Position and BP 5b Submerged Ballet Leg Double Position. 90° angle between the trunk and the legs maintained throughout the rotation.</p> <p>1.2 Body alignment and extension maintained throughout.</p>

BM 10 Vertical Descent

Basic Movement Description	NVT	Diagrams	Major Desired Actions
<p>1. Maintaining a Vertical Position the body descends along its longitudinal axis until the toes are submerged.</p>	14.0		<p>1. See BP 6 Vertical Position. The tempo of the descent is uniform and at the same speed as the rest of the figure.</p>

Aurora 330a, 330c – 330g – An Aurora is executed to **Vertical Position**. The designated *Twist* or *Spin* is executed.

Note: Refer to Section **BM 12 Twists & Twist Allowances** and Section **BM 13 Spins & Spin Allowances**.

Figure – 330a AURORA ½ TWIST

DIFFICULTY – 2.7

								Total
NVT=	6.0	8.0	16.0	14.0	20.5	21.0	14.0	99.5
PV =	0.60	0.80	1.61	1.41	2.06	2.11	1.41	10

Figure – 330 AURORA (cont.)

Aurora 330a, 330c – 330g – An Aurora is executed to **Vertical Position**. The designated *Twist* or *Spin* is executed.

Note: Refer to **Section BM 12 Twists & Twist Allowances** and **Section BM 13 Spins & Spin Allowances**.

Figure – 330c AURORA TWIRL

DIFFICULTY – 2.8

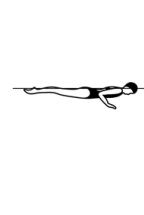
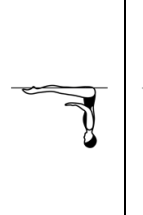
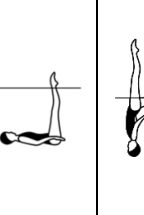
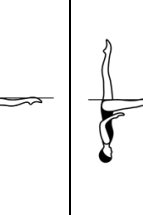
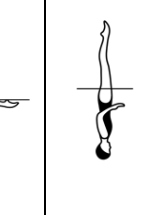
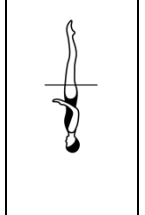
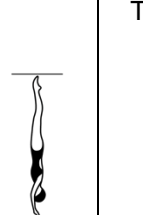
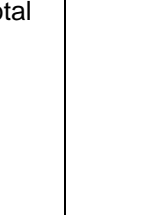
								Total
NVT=	6.0	8.0	16.0	14.0	20.5	26.0	14.0	104.5
PV =	0.57	0.77	1.53	1.34	1.96	2.49	1.34	10

Figure – 330d AURORA SPINNING 180°

DIFFICULTY – 2.3

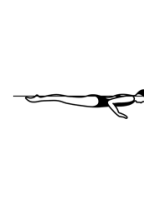
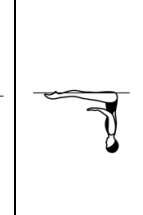
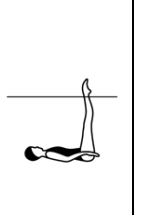
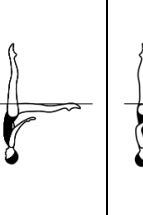
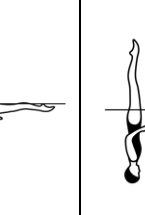
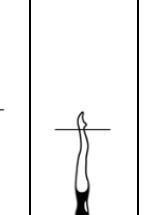
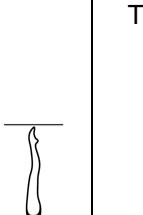
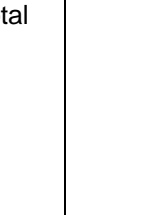
								Total
NVT=	6.0	8.0	16.0	14.0	20.5	16.0	0	80.5
PV =	0.75	0.99	1.99	1.74	2.55	1.99	0	10

Figure – 330e AURORA SPINNING 360°

DIFFICULTY – 2.4

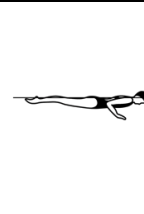
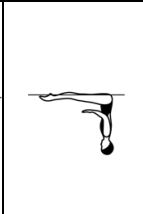
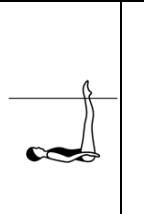
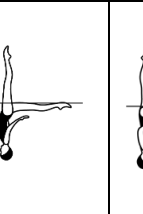
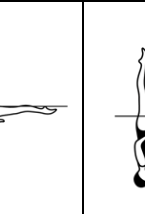
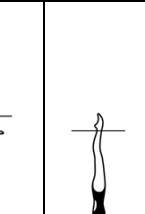
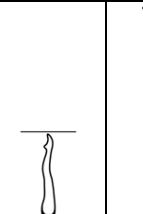
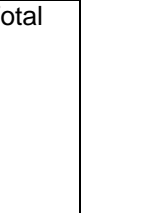
								Total
NVT=	6.0	8.0	16.0	14.0	20.5	19.0	0	83.5
PV =	0.72	0.96	1.92	1.68	2.46	2.28	0	10

Figure – 330 AURORA (cont.)

Aurora 330a, 330c – 330g – An Aurora is executed to **Vertical Position**. The designated *Twist* or *Spin* is performed to complete the figure.

Note: Refer to Section **BM 12 Twists & Twist Allowances** and Section **BM 13 Spins & Spin Allowances**.

Figure – 330f AURORA CONTINUOUS SPIN (720°) DIFFICULTY – 2.7







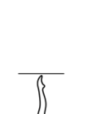

								Total
NVT=	6.0	8.0	16.0	14.0	20.5	34.0	98.5	
PV =	0.61	0.81	1.62	1.42	2.08	3.45	10	

Figure – 330g AURORA TWIST SPIN DIFFICULTY – 2.9







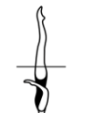


									Total
NVT=	6.0	8.0	16.0	14.0	20.5	48.0	112.5		
PV =	0.53	0.71	1.42	1.24	1.82	4.27	10		

Figure – 331 AURORA OPEN 180° DIFFICULTY – 3.0

From a **Front Layout Position** a Somersault Front Pike is executed to a **Submerged Ballet Leg Double Position**. The trunk and one leg rise vertically as the other leg moves along the surface of the water to assume a **Knight Position**. Maintaining the vertical alignment the body rotates 180° to assume a **Fishtail Position**. Maintaining the vertical alignment of the body, the foot of the horizontal leg is moved with accelerating speed in a horizontal arc of 180° at the surface of the water to a **Knight Position**. Maintaining the **Knight Position** the body moves with accelerating speed as an additional 180° rotation is executed in the same direction. The vertical leg is lowered to a **Surface Arch Position**. An *Arch to Back Layout Finish Action* is executed.






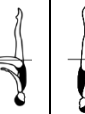



									Total
NVT=	6.0	8.0	16.0	14.0	21.0	24.0	18.5	7.0	114.5
PV =	0.52	0.70	1.40	1.22	1.83	2.10	1.62	0.61	10

Figure – 331 AURORA OPEN 180° (cont.)

DIFFICULTY – 3.0


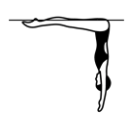
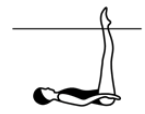
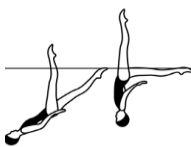


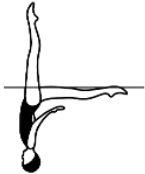


Figure Description	NVT	Diagrams	Major Desired Actions
1. From a Front Layout Position a Somersault Front Pike is executed to a Submerged Ballet Leg Double Position .			1. See BP 2 Front Layout Position , BP 10 Front Pike Position , BP 5b Submerged Ballet Leg Double Position , BM 3 <i>To Assume A Front Pike Position</i> and BM 4 <i>To Assume a Submerged Ballet Leg Double Position From A Front Pike Position</i> . Smooth even movement downwards of the trunk.
	6.0		
	8.0		
2. The trunk and one leg rise vertically as the other leg moves along the surface of the water to assume a Knight Position .	16.0		2.1 The trunk unrolls beneath the vertical leg. Movement of the trunk and the legs to BP 17 Knight Position is simultaneous with the rise. 2.2 Maximum height and body alignment achieved simultaneously.
3. Maintaining the vertical alignment the body rotates 180° to assume a Fishtail Position .	14.0		3.1 See BP 8 Fishtail Position . Height remains constant during the rotation. 3.2 Trunk, horizontal and vertical leg maintain alignment throughout the rotation.
4. Maintaining the vertical alignment of the body, the foot of the horizontal leg is moved with accelerating speed in a horizontal arc of 180° at the surface of the water to a Knight Position .	21.0		4.1 The vertical leg remains stationary and height remains constant throughout the rotation. 4.2 The foot of the horizontal leg is at the surface of the water and not above or below. 4.3 There is controlled acceleration and full extension of the horizontal leg throughout the 180° arcing movement at the surface of the water to BP 17 Knight Position .

Figure – 331 AURORA OPEN 180° (cont.)

DIFFICULTY – 3.0

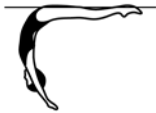
Figure Description	NVT	Diagrams	Major Desired Actions
5. Maintaining the Knight Position the body moves with accelerating speed as an additional 180° rotation is executed in the same direction.	24.0		<p>5.1 Full extension of both legs is maintained throughout the rotation.</p> <p>5.2 The angle between the legs remains constant, with BP 17 Knight Position maintained throughout.</p> <p>5.3 The entire body 'locks' into position and moves as a unit.</p> <p>5.4 Fluid continuous acceleration from BP 8 Fishtail Position to completion of the action.</p>
6. The vertical leg is lowered to a Surface Arch Position .	18.5		<p>See BP 13 Surface Arch Position.</p> <p>6.1 Hip and shoulder joints remain on a horizontal line.</p> <p>6.2 Hip height remains constant and at the surface of the water.</p> <p>6.3 Both legs maintain full extension.</p> <p>6.4 The trunk remains stationary until the feet join.</p> <p>6.5 No pause in BP 13 Surface Arch Position however an accurate surface arch must be evident before BM 5 <i>Arch to Back Layout Finish Action</i> occurs.</p>
7. An <i>Arch to Back Layout Finish Action</i> is executed.	7.0		<p>7. See BM 5 <i>Arch to Back Layout Finish Action</i>.</p>

See Figure 330 Aurora for **Front Layout Position, Front Pike Position, Submerged Ballet Leg Double Position, Knight Position, Fishtail Position, To Assume A Front Pike Position Basic Movement** and **To Assume a Submerged Ballet Leg Double Position From A Front Pike Position Basic Movement**.

Figure – 331 AURORA OPEN 180° (cont.)

DIFFICULTY – 3.0

BP 13 Surface Arch Position

Body Position Description	Diagrams	Major Desired Actions
1. Lower back arched with hips, shoulders and head on a vertical line.		1. Hip joints and shoulder joints on a horizontal line with both of these alignments 'square' and parallel to one another. Head (ears specifically) in line with shoulders.
2. Legs together and at the surface of the water.		2. Hips joints at the surface of the water.

BM 5 Arch to Back Layout Finish Action


Basic Movement Description	NVT	Diagrams	Major Desired Actions
1. From a Surface Arch Position the hips, chest and face surface sequentially at the same point with foot first movement to a Back Layout Position until the head occupies the position of the hips at the beginning of this action.	7.0		1. See BP 13 Surface Arch Position . Sharp arch in the lower back. The body rises, straightens and moves along the surface of the water with a stationary BP 1 Back Layout Position achieved as the face surfaces. Full extension maintained throughout.

Figure – 332 AURORA OPEN 360°

DIFFICULTY – 3.1

From a **Front Layout Position** a Somersault Front Pike is executed to a **Submerged Ballet Leg Double Position**. The trunk and one leg rise vertically as the other leg moves along the surface of the water to assume a **Knight Position**. Maintaining the vertical alignment the body rotates 180° to assume a **Fishtail Position**. Maintaining the vertical alignment of the body, the foot of the horizontal leg is moved with accelerating speed in a horizontal arc of 180° at the surface of the water to a **Knight Position**. Maintaining the **Knight Position** the body moves with accelerating speed as an additional 360° rotation is executed in the same direction. The vertical leg is lowered to a **Surface Arch Position**. An *Arch to Back Layout Finish Action* is executed.



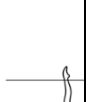




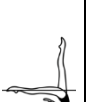
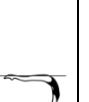

										Total
NVT=	6.0	8.0	16.0	14.0	21.0	34.0		18.5	7.0	124.5
PV =	0.48	0.64	1.29	1.12	1.69	2.73		1.49	0.56	10

Figure Description	NVT	Diagrams	Major Desired Actions
--------------------	-----	----------	-----------------------

1. From a **Front Layout Position** a Somersault Front Pike is executed to a **Submerged Ballet Leg Double Position**.



1. See Figure 331 Aurora Open 180° for step 1.

6.0

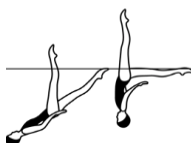


8.0



2. The trunk and one leg rise vertically as the other leg moves along the surface of the water to assume a **Knight Position**.

16.0



2. See Figure 331 Aurora Open 180° for step 2.

3. Maintaining the vertical alignment the body rotates 180° to assume a **Fishtail Position**.

14.0



3. See Figure 331 Aurora Open 180° for step 3.

4. Maintaining the vertical alignment of the body, the foot of the horizontal leg is moved with accelerating speed in a horizontal arc of 180° at the surface of the water to a **Knight Position**.

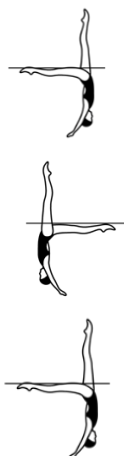


21.0



4. See Figure 331 Aurora Open 180° for step 4.

Figure – 332 AURORA OPEN 360° (cont.)

DIFFICULTY – 3.1

Figure Description	NVT	Diagrams	Major Desired Actions
<p>5. Maintaining the Knight Position the body moves with accelerating speed as an additional 360° rotation is executed in the same direction.</p>	34.0		<p>5.1 Full extension of both legs is maintained throughout the rotation. 5.2 The angle between the legs remains constant, with BP 17 Knight Position maintained throughout. 5.3 The entire body 'locks' into position and moves as a unit. 5.4 Fluid, continuous acceleration from BP 8 Fishtail Position to completion of the action.</p>
<p>6. The vertical leg is lowered to a Surface Arch Position.</p>	18.5		<p>6. See Figure 331 Aurora Open 180° for step 6.</p>
<p>7. An <i>Arch to Back Layout Finish Action</i> is executed.</p>	7.0		<p>7. See Figure 331 Aurora Open 180° for step 7.</p>

See Figure 330 Aurora for **Front Layout Position, Front Pike Position, Submerged Ballet Leg Double Position, Knight Position, Fishtail Position, To Assume A Front Pike Position Basic Movement and To Assume A Submerged Ballet Leg Double Position From A Front Pike Position Basic Movement**. See 331 Aurora Open 180° for **Surface Arch Position** and *Arch to Back Layout Basic Movement*.

Figure – 335 GAVIATA

DIFFICULTY – 2.3

From a **Front Layout Position** a Somersault Front Pike is executed to a **Submerged Ballet Leg Double Position**. A rising double leg *Catalina Rotation* is executed to a **Vertical Position**. The legs open symmetrically to a **Split Position**. A *Walkout Front* is executed.








							Total
NVT=	6.0	8.0	19.0	17.0	23.0	7.0	80
PV =	0.75	1.00	2.38	2.13	2.88	0.88	10

Figure Description	NVT	Diagrams	Major Desired Actions
--------------------	-----	----------	-----------------------

1. From a **Front Layout Position** a Somersault Front Pike is executed to a **Submerged Ballet Leg Double Position**.

6.0



8.0

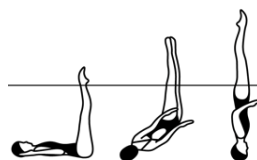


1. See BP 2 **Front Layout Position**, BP 10 **Front Pike Position**, BP 5b **Submerged Ballet Leg Double Position**, BM 3 *To Assume A Front Pike Position* and BM 4 *To Assume a Submerged Ballet Leg Double Position From A Front Pike Position*.

Smooth even movement downwards of the trunk.

2. A rising double leg *Catalina Rotation* is executed to a **Vertical Position**.

19.0



2.1 See BM 7 *Catalina Rotation* - adapted for Gaviata. Trunk movement from horizontal to vertical is simultaneous with hip rotation and body rise. Rotation is completed simultaneously as BP 6 **Vertical Position** is achieved.

2.2 Maximum height achieved as *Catalina Rotation* is completed.

3. The legs open symmetrically to a **Split Position**.




17.0





3. The legs lower simultaneously to BP 16a **Surface Split Position**. Hip level remains constant and legs equidistant from the surface of the water at all times.

Figure – 335 GAVIATA (cont.)

DIFFICULTY – 2.3

Figure Description	NVT	Diagrams	Major Desired Actions
4. A <i>Walkout Front</i> is executed.			4. See BM 6a <i>Walkout Front</i> and BM 5 <i>Arch to Back Layout Finish</i> Action.
	23.0		
	7.0		

BP 2 Front Layout Position

Body Position Description	Diagrams	Major Desired Actions
1. Body extended with head, upper back, buttocks and heels at the surface of the water.		1. Gives the impression that the body is stretched horizontally to its maximum. Judgement made by checking visual points of the horizontal alignment: ears, shoulder joints, hip joints and heels.
2. Unless otherwise specified, face may be in or out of the water.		2. Once the head position is established as in or out of the water the position is maintained. When the face is out of the water the ears will not be on the horizontal axis and the back may be slightly lower and arched. Hip joints, calves and heels remain at the surface of the water.

BP 10 Front Pike Position



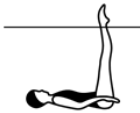
Body Position Description	Diagrams	Major Desired Actions
1. Body bent at hips to form a 90° angle.		1. Exact 90° angle.
2. Legs extended and together.		2. Full extension of legs, with ankles aligned with hip joints.
3. Trunk extended with the back straight and head in line.		3. Back flat, with vertical alignment of ears, shoulder joints and hip joints once the position is established.


Figure – 335 GAVIATA (cont.)

DIFFICULTY – 2.3

BP 5 Ballet Leg Double Position

Body Position Description	Diagrams	Major Desired Actions
<p>b) Submerged</p> <ol style="list-style-type: none"> 1. Trunk and head parallel to the surface of the water. 2. 90° angle between the trunk and the extended legs. 3. Water level between knees and ankles of the extended legs. 		<ol style="list-style-type: none"> 1. Ears, shoulder joints and hip joints aligned. 2. Legs perpendicular to the surface of the water. Body extended horizontally at 90° angle to the surface of the water.

BP 6 Vertical Position

Body Position Description	Diagrams	Major Desired Actions
<ol style="list-style-type: none"> 1. Body extended perpendicular to the surface of the water; legs together, head downward. 2. Head (ears specifically), hips and ankles in line. 		<ol style="list-style-type: none"> 1. Full extension of the body. 2. Judgement is made by checking visual points of the vertical alignment: ears, shoulder joints, hip joints and ankles.

BP 16 Split Position




Body Position Description	Diagrams	Major Desired Actions
<ol style="list-style-type: none"> 1. Legs evenly split forward and back. 2. The legs are parallel to the surface of the water. 3. Lower back arched, with hips, shoulders and head on a vertical line. 4. 180° angle between the extended legs (flat split), with inside of each leg aligned on opposite sides of a horizontal line, regardless of the height of the hips. 		<ol style="list-style-type: none"> 1. Full extension of the legs at or above the surface of the water. 4. Flat split. Hip joints and shoulder joints on a horizontal line, with both of these alignments 'square' and parallel to each other.
<p>a) Surface Split Position</p> <ol style="list-style-type: none"> 1. Legs are dry at the surface of the water. 		<ol style="list-style-type: none"> 1. Full extension of the legs. Crotch and legs dry at the surface of the water.


Figure – 335 GAVIATA (cont.)

DIFFICULTY – 2.3

BP 13 Surface Arch Position

Body Position Description	Diagrams	Major Desired Actions
1. Lower back arched with hips, shoulders and head on a vertical line.		1. Hip joints and shoulder joints on a horizontal line with both of these alignments 'square' and parallel to one another. Head (ears specifically) in line with shoulders.
2. Legs together and at the surface of the water.		2. Hips joints at the surface of the water.

BP 1 Back Layout Position

Body Position Description	Diagrams	Major Desired Actions
1. Body extended with face, chest, thighs and feet at the surface of the water.		1. Gives the impression that the body is stretched horizontally to its maximum. Front of the trunk will also be at the surface of the water.
2. Head (ears specifically), hips and ankles in horizontal alignment.		2. Judgement is made by checking visual points of the horizontal alignment: ears, shoulder joints, hip joints and ankles. This imaginary line should also pass through the middle of the side of the trunk.

BM 3 To Assume a Front Pike Position

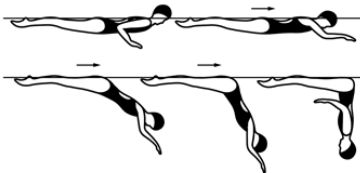

Basic Movement Description	NVT	Diagrams	Major Desired Actions
1. From a Front Layout Position with the face in the water the trunk moves downward to assume a Front Pike Position . The buttocks, legs and feet travel along the surface of the water until the hips occupy the position of the head at the beginning of this action.	6.0		1.1 See BP 2 Front Layout Position and BP 10 Front Pike Position . Uniform motion in downward movement of the trunk. The trunk remains straight throughout the movement. Hips and head lock into position simultaneously. 1.2 Unless otherwise specified, <i>To Assume a Front Pike Position</i> starts from a Front Layout Position .

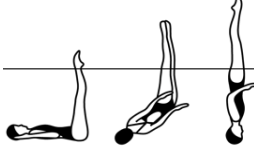
Figure – 335 GAVIATA (cont.)

DIFFICULTY – 2.3

BM 4 To Assume a Submerged Ballet Leg Double Position From A Front Pike Position

Basic Movement Description	NVT	Diagrams	Major Desired Actions
<p>1. While maintaining a Front Pike Position the body somersaults forward around a lateral axis as the buttocks, legs and feet move downward. The hips replace the head to assume a Submerged Ballet Leg Double Position.</p>	8.0		<p>1.1 See BP 10 Front Pike Position and BP 5b Submerged Ballet Leg Double Position. 90° angle maintained between the trunk and the legs throughout the rotation. 1.2 Body alignment and extension maintained throughout.</p>

BM 7 Catalina Rotation – adapted for Gaviata

Basic Movement Description	NVT	Diagrams	Major Desired Actions
<p>1. From a Ballet Leg Double Submerged Position, a rising double leg <i>Catalina Rotation</i> is executed to a Vertical Position.</p>	19.0		<p>1. Trunk movement from horizontal in BP 5b Ballet Leg Double Submerged Position to vertical is simultaneous with hip rotation and body rise. Rotation complete at BP 6 Vertical Position. Maximum height achieved as <i>Catalina Rotation</i> is completed.</p> <p>2. Height and tempo constant from Ballet Leg Double Submerged to Vertical Position.</p>

BM 6 Walkout


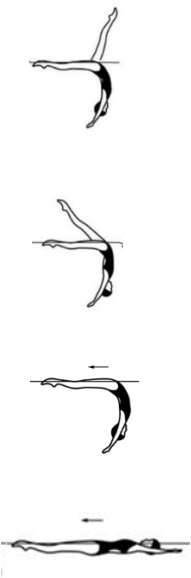
Basic Movement Description	NVT	Diagrams	Major Desired Actions
<p>1. These movements start in a Split Position unless otherwise specified in the figure description. The hips remain stationary as one leg is lifted in an arc over the surface of the water to meet the opposite leg.</p>			<p>1. See BP 16a Surface Split Position.</p>

Figure – 335 GAVIATA (cont.)

DIFFICULTY – 2.3

BM 6 Walkout (cont.)

Basic Movement Description	NVT	Diagrams	Major Desired Actions
<p>a) Walkout Front</p> <p>2. The front leg is lifted in a 180° arc over the surface of the water to meet the opposite leg in a Surface Arch Position and with continuous movement an <i>Arch to Back Layout Finish Action</i> is executed.</p>	<p>23.0</p> <p>7.0</p>		<p>2.1 Hip height remains constant and at the surface of the water.</p> <p>2.2 Arcing leg moves continuously with uniform motion.</p> <p>2.3 Both legs maintain full extension.</p> <p>2.4 The trunk remains stationary until the feet join.</p> <p>2.5 No pause in BP 13 Surface Arch Position, however an accurate surface arch must be evident before the body begins to rise and straighten.</p> <p>2.6 Foot first surfacing motion begins when the feet are joined.</p> <p>2.7 See BP 13 Surface Arch Position and BM 5 <i>Arch to Back Layout Finish Action</i>.</p>

BM 5 Arch to Back Layout Finish Action

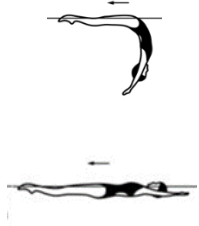
Basic Movement Description	NVT	Diagrams	Major Desired Actions
<p>1. From a Surface Arch Position the hips, chest and face surface sequentially at the same point with foot first movement to a Back Layout Position until the head occupies the position of the hips at the beginning of this action.</p>	<p>7.0</p>		<p>1. See BP 13 Surface Arch Position. Sharp arch in the lower back. The body rises, straightens and moves along the surface of the water with a stationary BP 1 Back Layout Position achieved as the face surfaces. Full extension maintained throughout.</p>

Figure – 336 GAVIATA OPEN 180°

DIFFICULTY – 2.4

From a **Front Layout Position** a Somersault Front Pike is executed to a **Submerged Ballet Leg Double Position**. A rising double leg *Catalina Rotation* is executed to a **Vertical Position**. Continuing in the same direction the legs open symmetrically during a 180° rotation to a **Split Position**. A *Walkout Front* is executed.








							Total
NVT=	6.0	8.0	19.0	20.0	23.0	7.0	83
PV =	0.72	0.96	2.29	2.41	2.77	0.84	10

Figure Description	NVT	Diagrams	Major Desired Actions
--------------------	-----	----------	-----------------------

1. From a **Front Layout Position** a Somersault Front Pike is executed to a **Submerged Ballet Leg Double Position**. A rising double leg *Catalina Rotation* is executed to a **Vertical Position**.

6.0



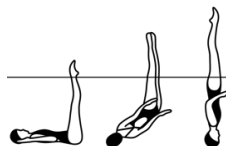
1. See Figure 335 Gaviata step 1.

8.0



2. A rising double leg *Catalina Rotation* is executed to a **Vertical Position**.

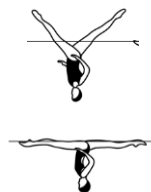
19.0



2. See Figure 335 Gaviata step 2.

3. Continuing in the same direction the legs open symmetrically during a 180° rotation to a **Split Position**.

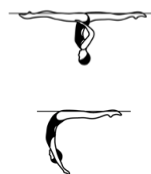
20.0



3. With continuous motion the body turns 180° on its longitudinal axis as the legs lower simultaneously to BP 16a **Surface Split Position**. Hip level remains constant and legs equidistant from the surface of the water at all times.

4. A *Walkout Front* is executed.

23.0



4. See BM 6a *Walkout Front* and BM 5 *Arch to Back Layout Finish Action*.

7.0



Figure – 336 GAVIATA OPEN 180° (cont.)

DIFFICULTY – 2.4

Figure Description	NVT	Diagrams	Major Desired Actions
--------------------	-----	----------	-----------------------

See Figure 335 Gaviata for **Front Layout Position, Front Pike Position, Submerged Ballet Leg Double Position, Vertical Position, Split Position, Surface Arch Position, Back Layout Position, To Assume A Front Pike Position Basic Movement, Submerged Ballet Leg Double Position From A Front Pike Position Basic Movement, Walkout Front Basic Movement and Arch to Back Layout Finish Action Basic Movement.**

Figure – 342 HERON

DIFFICULTY – 1.9

From a **Front Layout Position** a Somersault Front Pike is executed to a **Submerged Ballet Leg Double Position**. As the trunk moves toward the legs one leg is bent with the shin parallel to the surface of the water and the mid-calf opposite the vertical leg. A *Thrust* is executed to a **Bent Knee Vertical Position** with the foot of the bent leg moving simultaneously to the inside of the vertical leg during the *Thrust*. A *Vertical Descent* is executed in a **Bent Knee Vertical Position** at the same tempo as the *Thrust*.







						Total
						
NVT=	6.0	8.0	5.0	28.0	11.0	58
PV =	1.03	1.38	0.86	4.83	1.90	10

Figure Description	NVT	Diagrams	Major Desired Actions
--------------------	-----	----------	-----------------------

1. From a **Front Layout Position** a Somersault Front Pike is executed to a **Submerged Ballet Leg Double Position**.

6.0



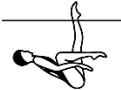
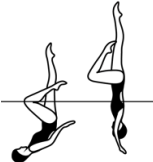

8.0



1. See BP 2 **Front Layout Position**, BP 10 **Front Pike Position**, BP 5b **Submerged Ballet Leg Double Position**, BM 3 *To Assume A Front Pike Position* and BM 4 *To Assume a Submerged Ballet Leg Double Position From A Front Pike Position*.
Smooth even movement downwards of the trunk.

Figure – 342 HERON (cont.)

DIFFICULTY – 1.9

Figure Description	NVT	Diagrams	Major Desired Actions
2. As the trunk moves toward the legs one leg is bent with the shin parallel to the surface of the water and the mid-calf opposite the vertical leg.	5.0		2. See BP 4b Submerged Flamingo Position . There is no pause in this position however it should be clearly evident at the completion of the transition prior to the <i>Thrust</i> . The water level remains constant on the vertical leg.
3. A <i>Thrust</i> is executed to a Bent Knee Vertical Position with the foot of the bent leg moving simultaneously to the inside of the vertical leg during the <i>Thrust</i> .	28.0		3. See BM 9 <i>Thrust</i> – adapted for Heron. Obvious increase in speed. BP 14c Bent Knee Vertical and maximum height achieved simultaneously and clearly defined prior to initiation of the descent.
4. A <i>Vertical Descent</i> is executed in a Bent Knee Vertical Position at the same tempo as the <i>Thrust</i> .	11.0		4. See BP 14c Bent Knee Vertical Position and BM 10 <i>Vertical Descent</i> . The vertical line is maintained throughout the descent.

BP 2 Front Layout Position





Body Position Description	Diagrams	Major Desired Actions
1. Body extended with head, upper back, buttocks and heels at the surface of the water.		1. Gives the impression that the body is stretched horizontally to its maximum. Judgement made by checking visual points of the horizontal alignment: ears, shoulder joints, hip joints and heels.
2. Unless otherwise specified, face may be in or out of the water.		2. Once the head position is established as in or out of the water the position is maintained. When the face is out of the water the ears will not be on the horizontal axis and the back may be slightly lower and arched. Hip joints, calves and heels remain at the surface of the water.


Figure – 342 HERON (cont.)

DIFFICULTY – 1.9

BP 10 Front Pike Position

Body Position Description	Diagrams	Major Desired Actions
1. Body bent at hips to form a 90° angle.		1. Exact 90° angle.
2. Legs extended and together.		2. Full extension of legs, with ankles aligned with hip joints.
3. Trunk extended with the back straight and head in line.		3. Back flat, with vertical alignment of ears, shoulder joints and hip joints once the position is established.

BP 5 Ballet Leg Double Position

Body Position Description	Diagrams	Major Desired Actions
b) Submerged		
1. Trunk and head parallel to the surface of the water.		1. Ears, shoulder joints and hip joints aligned.
2. 90° angle between the trunk and the extended legs.		2. Legs perpendicular to the surface of the water. Body extended horizontally at 90° angle to the surface of the water.
3. Water level between knees and ankles of the extended legs.		

BP 4 Flamingo Position

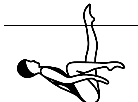
Body Position Description	Diagrams	Major Desired Actions
b) Submerged		
1. Trunk, head, shin and foot of the bent leg parallel to the surface of the water.		1. Ears, shoulder joints and hip joints aligned.
2. 90° angle between the trunk and extended leg.		2. The vertical leg is extended perpendicular to the bent leg midway between the knee and the ankle of the horizontal leg.
3. Water level between knee and ankle of the extended leg.		

Figure – 342 HERON (cont.)

DIFFICULTY – 1.9

BP 14 Bent Knee Position

Body Position Description	Diagrams	Major Desired Actions
One leg bent with the toe of the bent leg in contact with the inside of the extended leg at the knee or higher.		The relationship of the toe of the bent leg to the extended leg may vary depending on the figure but should remain constant once established, and not extend in front of or behind the extended leg.

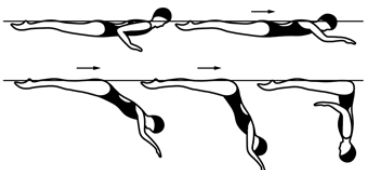
c) Bent Knee Vertical Position

1. Body extended in **Vertical Position** with the thigh of the bent leg parallel to the surface of the water.



1. In BP 6 **Vertical Position** the alignment of the extended leg, trunk and head remains constant.

BM 3 To Assume a Front Pike Position

Basic Movement Description	NVT	Diagrams	Major Desired Actions
1. From a Front Layout Position with the face in the water the trunk moves downward to assume a Front Pike Position . The buttocks, legs and feet travel along the surface of the water until the hips occupy the position of the head at the beginning of this action.	6.0		1.1 See BP 2 Front Layout Position and BP 10 Front Pike Position . Uniform motion in downward movement of the trunk. The trunk remains straight throughout the movement. Hips and head lock into position simultaneously. 1.2 Unless otherwise specified, <i>To Assume a Front Pike Position</i> starts from a Front Layout Position .

BM 4 To Assume a Submerged Ballet Leg Double Position From A Front Pike Position


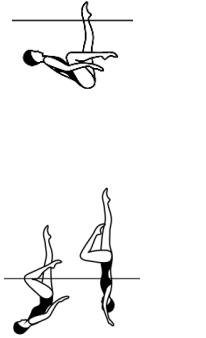
Basic Movement Description	NVT	Diagrams	Major Desired Actions
1. While maintaining a Front Pike Position the body somersaults forward around a lateral axis as the buttocks, legs and feet move downward. The hips replace the head to assume a Submerged Ballet Leg Double Position .	8.0		1.1 See BP 10 Front Pike Position and BP 5b Submerged Ballet Leg Double Position . 90° angle between the trunk and the legs maintained throughout the rotation. 1.2 Body alignment and extension maintained throughout.

Figure – 342 HERON (cont.)

DIFFICULTY – 1.9

BM 9 Thrust – adapted for Heron

Basic Movement Description	NVT	Diagrams	Major Desired Actions
<p>1. From a Submerged Flamingo Position with the ballet leg perpendicular to the surface of the water, a vertical upward movement of the legs and hips is rapidly executed as the body unrolls and one foot is drawn along the inside of the extended leg to assume a Bent Knee Vertical Position.</p>	28.0		<p>1.1 From the BP 4b Submerged Flamingo Position the body unrolls rapidly under the legs to assume BP 14c Bent Knee Vertical Position along the same perpendicular line established by the vertical leg in the BP 4b Submerged Flamingo Position.</p> <p>1.2 Obvious increase in speed of action from the initiation of body unrolling through the vertical upward movement.</p> <p>2. Maximum height and BP 14c Bent Knee Vertical Position achieved simultaneously.</p>
<p>2. Maximum height is desirable.</p>			

BM 10 Vertical Descent in Bent Knee Vertical Position

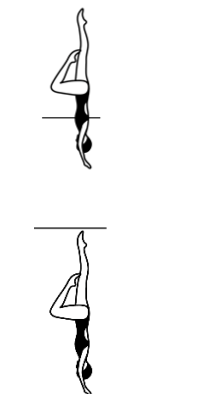
Basic Movement Description	NVT	Diagrams	Major Desired Actions
<p>1. Maintaining a Bent Knee Vertical Position, the body descends along its longitudinal axis until the toes are submerged.</p>	11.0		<p>1. See BP 14c Bent Knee Vertical Position.</p> <p>2. The descent is executed at the same tempo as BM 9 <i>Thrust</i>.</p>



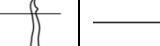



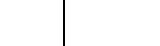
Figure – 342 HERON (cont.)

Figure – 342c HERON TWIRL

DIFFICULTY – 2.4

Heron 342c – A Heron is executed to a **Bent Knee Vertical Position**. A *Twirl* is executed. A *Vertical Descent* is executed at the same tempo as the *Thrust*.

Note: Refer to Section BM 12 Twists & Twist Allowances.

							Total
NVT=	6.0	8.0	5.0	28.0	25.0	11.0	83
PV =	0.72	0.96	0.60	3.37	3.01	1.33	10

Heron 342d – 342f – A Heron is executed to a **Bent Knee Vertical Position**. The designated *Spin* is performed in a **Bent Knee Vertical Position** at the same tempo as the *Thrust*.

Note: Refer to Section BM 13 Spins & Spin Allowances.

Figure – 342d HERON SPINNING 180°

DIFFICULTY – 2.1



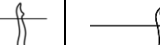




							Total
NVT=	6.0	8.0	5.0	28.0	21.0	0	68
PV =	0.88	1.18	0.74	4.12	3.09	0	10

Figure – 342e HERON SPINNING 360°

DIFFICULTY – 2.2



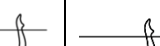


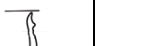

							Total
NVT=	6.0	8.0	5.0	28.0	27.0	0	74
PV =	0.81	1.08	0.68	3.78	3.65	0	10







Figure – 342 HERON (cont.)

Heron 342d – 342f – A Heron is executed to a **Bent Knee Vertical Position**. The designated *Spin* is performed in a **Bent Knee Vertical Position** at the same tempo as the *Thrust*.

Note: Refer to Section BM 13 Spins & Spin Allowances.

Figure – 342f HERON CONTINUOUS SPIN (720°)

DIFFICULTY – 2.4

						Total
NVT=	6.0	8.0	5.0	28.0	36.0	83
PV =	0.72	0.96	0.60	3.37	4.34	10

Heron 342h and 342i – A Heron is executed to a **Bent Knee Vertical Position**. A *Vertical Descent* in a **Bent Knee Vertical Position** is executed to ankle level at the same tempo as the *Thrust*. The designated *ascending Spin* is performed in a **Bent Knee Vertical Position** at the same tempo as prior to the *Thrust*. A *Vertical Descent* is executed in a **Bent Knee Vertical Position** at the same tempo as the *Thrust*.

****ascending Spin:** The *ascending Spin* should NOT be performed rapidly. The *ascending Spin* should be performed as the body rises and rotates simultaneously, evenly and at the same tempo from the start of the figure to **Submerged Flamingo Position**.

Note: Refer to Section BM 13 Spins & Spin Allowances.

Figure – 342h HERON SPIN UP 180°

DIFFICULTY – 2.4


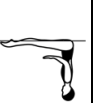






								Total
NVT=	6.0	8.0	5.0	28.0	11.0	16.0	11.0	85
PV =	0.71	0.94	0.59	3.29	1.29	1.88	1.29	10

Figure – 342 HERON (cont.)

Heron 342h and 342i – A Heron is executed to a **Bent Knee Vertical Position**. A *Vertical Descent* in a **Bent Knee Vertical Position** is executed to ankle level at the same tempo as the *Thrust*. The designated *ascending Spin* is performed in a **Bent Knee Vertical Position** at the same tempo as prior to the *Thrust*. A *Vertical Descent* is executed in a **Bent Knee Vertical Position** at the same tempo as the *Thrust*.

****ascending Spin:** The *ascending Spin* should NOT be performed rapidly. The *ascending Spin* should be performed as the body rises and rotates simultaneously, evenly and at the same tempo from the start of the figure to **Submerged Flamingo Position**.

Note: Refer to Section BM 13 Spins & Spin Allowances.

Figure – 342i HERON SPIN UP 360°

DIFFICULTY – 2.4





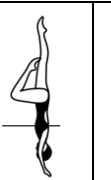

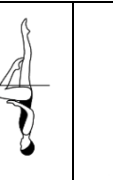
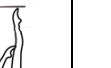
								Total
NVT=	6.0	8.0	5.0	28.0	11.0	17.0	11.0	86
PV =	0.70	0.93	0.58	3.26	1.28	1.98	1.28	10

Figure – 343 BUTTERFLY

DIFFICULTY – 2.5

From a **Front Layout Position** a *Front Pike Position* is assumed. One leg is lifted to a **Fishtail Position**. The horizontal leg is rapidly lifted through an arc of 180° over the surface of the water as the vertical leg is lowered to assume a **Split Position**. Without a pause a rapid hip rotation of 180° is executed as the front leg is raised to assume a **Fishtail Position**. The horizontal leg is lifted to a **Vertical Position** at the same tempo as the movement from the **Front Layout Position** to the first **Fishtail Position**. A *Vertical Descent* is executed.





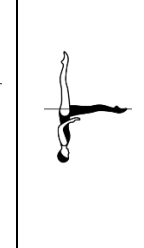
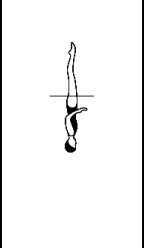
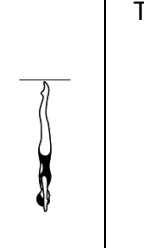
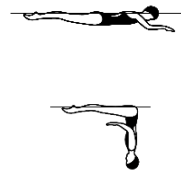
							Total
NVT=	6.0	14.5	20.0	16.5	20.5	14.0	91.5
PV =	0.66	1.58	2.19	1.80	2.24	1.53	10

Figure Description	NVT	Diagrams	Major Desired Actions
--------------------	-----	----------	-----------------------

1. From a **Front Layout Position** a *Front Pike Position* is assumed.

6.0

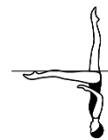


1. See BP 2 **Front Layout**, BP 10 **Front Pike Position** and BM 3 *To Assume a Front Pike Position*.

Smooth even movement downwards of the trunk.

2. One leg is lifted to a **Fishtail Position**.

14.5



2.1 See BP 8 **Fishtail Position**. Height and vertical alignment of the trunk is maintained.
2.2 The **Fishtail Position** is held only long enough to define the position and to demonstrate completion of the transition.

Figure – 343 BUTTERFLY (cont.)

DIFFICULTY – 2.5






Figure Description	NVT	Diagrams	Major Desired Actions
<p>3. The horizontal leg is rapidly lifted through an arc of 180° over the surface of the water as the vertical leg is lowered to assume a Split Position. Without a pause a rapid hip rotation of 180° is executed as the front leg is raised to assume a Fishtail Position.</p> <p>It is important to note that the horizontal leg in the first Fishtail Position must become the back leg in the Split Position and then must become the horizontal leg in the second Fishtail Position.</p> <p>The diagram shows the Fishtail Position to the Split Position and back to the Fishtail Position movements performed with the right (R) leg shaded black however either leg can be used to perform the action.</p>	<p>20.0</p> <p>16.5</p>		<p>3.1 See BP 16a Surface Split Position and BP 8 Fishtail Position. There is a sharp increase in speed from the Fishtail Position to Split Position. Both legs move simultaneously to achieve Split Position.</p> <p>3.2 The horizontal leg in the Fishtail Position becomes the back leg in the Split Position. From the split position to the second Fishtail Position the back leg remains stationary and at the surface of the water during the rapid 180° rotation and lifting of the front leg to Vertical Position.</p> <p>3.3 The trunk maintains its vertical alignment with hips and shoulders 'square'.</p>
<p>4. The horizontal leg is lifted to a Vertical Position at the same tempo as the movement from the Front Layout Position to the first Fishtail Position.</p>	<p>20.5</p>		<p>4.1 See BP 6 Vertical Position. Height is constant as the legs join, with the trunk and the vertical leg maintaining vertical alignment.</p> <p>4.2 The Vertical Position is held only long enough to define the position and to demonstrate completion of the transition.</p>
<p>5. A <i>Vertical Descent</i> is executed</p>	<p>14.0</p>		<p>5. See BM 10 <i>Vertical Descent</i>.</p>

Figure – 343 BUTTERFLY (cont.)

DIFFICULTY – 2.5

BP 2 Front Layout Position

Body Position Description	Diagrams	Major Desired Actions
<p>1. Body extended with head, upper back, buttocks and heels at the surface of the water.</p>		<p>1. Gives the impression that the body is stretched horizontally to its maximum. Judgement made by checking visual points of the horizontal alignment: ears, shoulder joints, hip joints and heels.</p>
<p>2. Unless otherwise specified, face may be in or out of the water.</p>		<p>2. Once the head position is established as in or out of the water the position is maintained. When the face is out of the water the ears will not be on the horizontal axis and the back may be slightly lower and arched. Hip joints, calves and heels remain at the surface of the water.</p>

BP 10 Front Pike Position




Body Position Description	Diagrams	Major Desired Actions
<p>1. Body bent at hips to form a 90° angle.</p>		<p>1. Exact 90° angle.</p>
<p>2. Legs extended and together.</p>		<p>2. Full extension of legs, with ankles aligned with hip joints.</p>
<p>3. Trunk extended with the back straight and head in line.</p>		<p>3. Back flat, with vertical alignment of ears, shoulder joints and hip joints once the position is established.</p>


Figure – 343 BUTTERFLY (cont.)

DIFFICULTY – 2.5

BP 8 Fishtail Position

Body Position Description	Diagrams	Major Desired Actions
<p>1. Body extended in Vertical Position with one leg extended forward. The foot of the forward leg is at the surface of the water regardless of the height of the hips.</p>		<p>1. See BP 6 Vertical Position for body alignment. The foot of the forward leg must be at the surface of the water. Hip joints must be on a horizontal line.</p>

BP 16 Split Position

Body Position Description	Diagrams	Major Desired Actions
<p>1. Legs evenly split forward and back. 2. The legs are parallel to the surface of the water. 3. Lower back arched, with hips, shoulders and head on a vertical line. 4. 180° angle between the extended legs (flat split), with inside of each leg aligned on opposite sides of a horizontal line, regardless of the height of the hips.</p>		<p>1. Full extension of the legs at or above the surface of the water.</p> <p>4. Flat split. Hip joints and shoulder joints on a horizontal line, with both of these alignments 'square' and parallel to each other.</p>

a) Surface Split Position

1. Legs are dry at the surface of the water.



1. Full extension of the legs. Crotch and legs dry at the surface of the water.

BP 6 Vertical Position


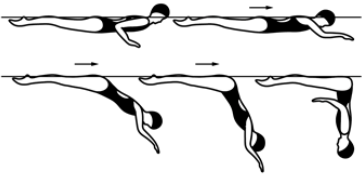
Body Position Description	Diagrams	Major Desired Actions
<p>1. Body extended perpendicular to the surface of the water; legs together, head downward.</p>		<p>1. Full extension of the body.</p>
<p>2. Head (ears specifically), hips and ankles in line.</p>		<p>2. Judgement is made by checking visual points of the vertical alignment: ears, shoulder joints, hip joints and ankles.</p>

Figure – 343 BUTTERFLY (cont.)

DIFFICULTY – 2.5

BM 3 To Assume a Front Pike Position/A Front Pike Position is assumed

Basic Movement Description	NVT	Diagrams	Major Desired Actions
<p>1. From a Front Layout Position with the face in the water the trunk moves downward to assume a Front Pike Position. The buttocks, legs and feet travel along the surface of the water until the hips occupy the position of the head at the beginning of this action.</p>	6.0		<p>1.1 See BP 2 Front Layout Position and BP 10 Front Pike Position. Uniform motion in downward movement of the trunk. The trunk remains straight throughout the movement. Hips and head lock into position simultaneously.</p> <p>1.2 Unless otherwise specified, <i>To Assume a Front Pike Position</i> starts from a Front Layout Position.</p>

BM 10 Vertical Descent

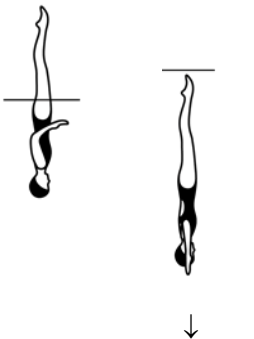
Basic Movement Description	NVT	Diagrams	Major Desired Actions
<p>1. Maintaining a Vertical Position the body descends along its longitudinal axis until the toes are submerged.</p>	14.0		<p>1. See BP 6 Vertical Position. The tempo of the descent matches the speed of the horizontal leg lift to Vertical Position.</p>

Figure – 344 NEPTUNUS

DIFFICULTY – 1.6

From a **Front Layout Position** a *Front Pike Position* is assumed. One leg is lifted to a **Fishtail Position**. The horizontal leg is bent to assume a **Bent Knee Vertical Position**. The bent leg is extended to meet the vertical leg while descending and assuming a **Vertical Position** at ankle level. A *Vertical Descent* is executed.







						Total
NVT=	6.0	14.5	12.5	9.0	0	42
PV =	1.43	3.45	2.98	2.14	0	10

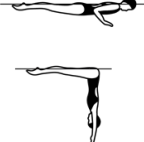



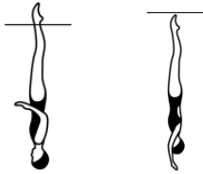
Figure Description	NVT	Diagrams	Major Desired Actions
1. From a Front Layout Position a <i>Front Pike Position</i> is assumed.	6.0		1. See BP 2 Front Layout , BP 10 Front Pike Position and BM 3 <i>To Assume a Front Pike Position</i> . Smooth even movement downwards of the trunk.
2. One leg is lifted to a Fishtail Position .	14.5		2.1 See BP 8 Fishtail Position . Height and vertical alignment of the trunk is maintained. 2.2 The Fishtail Position is held only long enough to define the position and to demonstrate completion of the transition.
3. The horizontal leg is bent to assume a Bent Knee Vertical Position .	12.5		3. See BP 6 Vertical Position and BP14c Bent Knee Vertical Position . Height, stability and vertical body alignment maintained throughout.

Figure – 344 NEPTUNUS (cont.)

DIFFICULTY – 1.6

Figure Description	NVT	Diagrams	Major Desired Actions
4. The bent leg is extended to meet the vertical leg while descending and assuming a Vertical Position at ankle level.	9.0		<p>4.1 See BM 10 <i>Vertical Descent</i>. Body alignment remains constant during the extension of the bent knee.</p> <p>4.2 The joining of the bent leg to vertical and the establishment of BP 6 Vertical Position at ankle level are achieved simultaneously. The bent leg is extended upward at the same rate of space and time as that of the drop spaces of the vertical leg.</p>
5. A <i>Vertical Descent</i> is executed.	0		<p>5. See BM 10 <i>Vertical Descent</i> - from ankle level.</p>

See Figure 343 Butterfly for **Front Layout Position, Front Pike Position, Fishtail Position, Vertical Position** and *To Assume a Front Pike Basic Movement*.

BP 14 Bent Knee Position



Body Position Description	Diagrams	Major Desired Actions
One leg bent with the toe of the bent leg in contact with the inside of the extended leg at the knee or higher.		<p>The relationship of the toe of the bent leg to the extended leg may vary depending on the figure but should remain constant once established, and not extend in front of or behind the extended leg.</p>
<p>c) Bent Knee Vertical Position</p> <p>1. Body extended in Vertical Position with the thigh of the bent leg parallel to the surface of the water.</p>		<p>1. In BP 6 Vertical Position the alignment of the extended leg, trunk and head remains constant.</p>

Figure – 344 NEPTUNUS (cont.)
DIFFICULTY – 1.6
BM 10 Vertical Descent - from ankle level

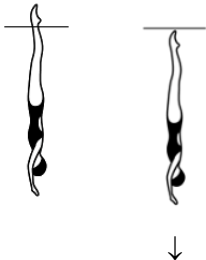
Basic Movement Description	NVT	Diagrams	Major Desired Actions
1. Maintaining a Vertical Position the body descends along its longitudinal axis until the toes are submerged.	0		1. See BP 6 Vertical Position . The tempo of the descent is uniform and at the same speed as the rest of the figure.

Figure – 345 CATALINA REVERSE

DIFFICULTY – 2.1

From a **Front Layout Position** a *Front Pike Position* is assumed. One leg is lifted to a **Fishtail Position**. A *Catalina Reverse Rotation* is executed. The *Ballet Leg* is lowered.



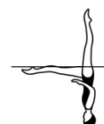



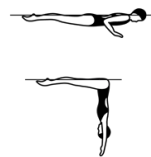
						Total
NVT=	6.0	14.5	24.0	11.0	10.5	66
PV =	0.91	2.20	3.64	1.67	1.59	10

Figure Description	NVT	Diagrams	Major Desired Actions
--------------------	-----	----------	-----------------------

1. From a **Front Layout Position** a *Front Pike Position* is assumed.

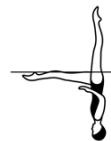
6.0



1. See BP 2 **Front Layout**, BP 10 **Front Pike Position** and BM 3 *To Assume a Front Pike Position*. Smooth even movement downwards of the trunk.

2. One leg is lifted to a **Fishtail Position**.

14.5



2.1 See BP 8 **Fishtail Position**. Height and vertical alignment of the trunk maintained.
2.2 The **Fishtail Position** is held only long enough to define the position and to demonstrate completion of the transition.

3. A *Catalina Reverse Rotation* is executed.

24.0



3. See BM 8 *Catalina Reverse Rotation* and BP 3a **Surface Ballet Leg Position**. Height on the vertical leg remains constant.

4. *The Ballet Leg is lowered.*

11.0



4. See BM 2 *To Lower A Ballet Leg*.

10.5




See Figure 343 Butterfly for **Front Layout Position, Front Pike Position Fishtail Position** and *To Assume a Front Pike Basic Movement*.

Figure – 345 CATALINA REVERSE (cont.)

DIFFICULTY – 2.1

BP 3 Ballet Leg Position

Body Position Description	Diagrams	Major Desired Actions
<p>a) Surface</p> <p>1. Body in Back Layout Position.</p> <p>2. One leg extended perpendicular to the surface of the water.</p>		<p>1. See BP 1 Back Layout Position. Ears, shoulder joints, hip joints and ankle of extended leg in line at maximum horizontal alignment.</p> <p>2. 90° angle between the extended leg and the surface of the water and between the extended leg and the trunk with maximum horizontal alignment maintained throughout.</p>

BP 14 Bent Knee Position



Body Position Description	Diagrams	Major Desired Actions
<p>One leg bent with the toe of the bent leg in contact with the inside of the extended leg at the knee or higher.</p>		<p>The relationship of the toe of the bent leg to the extended leg may vary depending on the figure but should remain constant once established, and not extend in front of or behind the extended leg.</p>
<p>b) Bent Knee Back Layout Position</p> <p>1. Body extended in Back Layout Position.</p> <p>2. The thigh of the bent leg is perpendicular to the surface of the water.</p>		<p>1. In BP 1 Back Layout Position ears, shoulder joints, hip joints and ankle of extended leg in line at maximum horizontal alignment.</p> <p>2. 90° angle between the thigh and the surface of the water, and 90° angle maintained between the thigh and the trunk. At maximum height an air pocket will be evident between the back of the thigh and calf of the bent leg and the surface of the water.</p>

Figure – 345 CATALINA REVERSE (cont.)

DIFFICULTY – 2.1

BP 1 Back Layout Position

Body Position Description	Diagrams	Major Desired Actions
1. Body extended with face, chest, thighs and feet at the surface of the water.		1. Gives the impression that the body is stretched horizontally to its maximum. Front of the trunk will also be at the surface of the water.
2. Head (ears specifically), hips and ankles in horizontal alignment.		2. Judgement is made by checking visual points of the horizontal alignment: ears, shoulder joints, hip joints and ankles. This imaginary line should also pass through the middle of the side of the trunk.

BM 8 Catalina Reverse Rotation



Basic Movement Description	NVT	Diagrams	Major Desired Actions
1. From a Fishtail Position the hips rotate as the trunk rises without lateral movement to assume a Ballet Leg Position .	24.0		<p>1.1 See BP 8 Fishtail and BP 3a Surface Ballet Leg Positions.</p> <p>1.2 Height maintained and uniform motion throughout.</p> <p>1.3 The body rotates and rises simultaneously along the vertical line established by the vertical leg.</p> <p>1.4 The transition is completed as the face surfaces and the body locks into BP 3a Surface Ballet Leg Position.</p> <p>1.5 At the halfway point, the body is in a tilted 'Y' position, with the trunk at a 45° angle to the surface of the water and the head, trunk and legs face forward.</p>
2. The vertical leg remains perpendicular to the surface of the water while the foot of the horizontal leg remains at the surface of the water throughout the rotation.			2. Each leg rotates around its respective horizontal or vertical axis simultaneously throughout the rotation of the ascending trunk.

Figure – 345 CATALINA REVERSE (cont.)

DIFFICULTY – 2.1

BM 2 To Lower a Ballet Leg/A Ballet Leg is lowered




Basic Movement Description	NVT	Diagrams	Major Desired Actions
<p>1. From a Ballet Leg Position the ballet leg is bent without movement of the thigh to a Bent Knee Back Layout Position.</p>			<p>1. See BP 3a Surface Ballet Leg Position and BP 14b Bent Knee Back Layout Position. The height remains constant throughout the movement.</p>
<p>2. The toe moves along the inside of the extended leg until a Back Layout Position is assumed.</p>	11.0		<p>2.1 Full extension in BP 1 Back Layout Position to be achieved as the feet are joined.</p>
	10.5		<p>2.2 The head and trunk remain stationary throughout.</p>

Figure – 346 SIDE FISHTAIL SPLIT

DIFFICULTY – 2.0

From a **Front Layout Position** a *Front Pike Position* is assumed. One leg is lifted to vertical as the body rotates 90° on its longitudinal axis to assume a **Side Fishtail Position**. With continuous motion another 90° rotation is executed in the same direction as the vertical leg is lowered to assume a **Split Position**. The legs are lifted to **Vertical Position**. A *Vertical Descent* is executed.



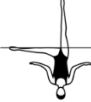



						Total
NVT=	6.0	23.0	20.0	14.0		63
PV =	0.95	3.65	3.17	2.22		10

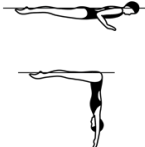
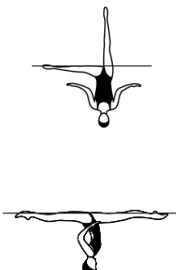




Figure Description	NVT	Diagrams	Major Desired Actions
1. From a Front Layout Position a <i>Front Pike Position</i> is assumed.	6.0		1. See BP 2 Front Layout , BP 10 Front Pike Position and BM 3 <i>To Assume a Front Pike Position</i> . Smooth even movement downwards of the trunk.
2. One leg is lifted to vertical as the body rotates 90° on its longitudinal axis to assume a Side Fishtail Position . With continuous motion another 90° rotation is executed in the same direction as the vertical leg is lowered to assume a Split Position .	23.0		2.1 Constant height and continuous motion as the body rotates simultaneously with the 180° leg arc over the surface of the water to BP 16a Surface Split Position . 2.2 BP 19 Side Fishtail Position must be clearly evident. There is no pause in this position as the leg passes through the mid-point of the 180° arc over the surface of the water. 2.3 Vertical alignment of the trunk must be maintained throughout the rotation.

Figure – 346 SIDE FISHTAIL SPLIT (cont.)

DIFFICULTY – 2.0

Figure Description	NVT	Diagrams	Major Desired Actions
3. The legs are lifted to Vertical Position .	20.0		3. Maximum height and stability maintained throughout. Both legs always equidistant from the surface of the water with BP 6 Vertical Position achieved as feet join.
4. A <i>Vertical Descent</i> is executed.	14.0		4. See BM 10 <i>Vertical Descent</i> .

BP 2 Front Layout Position

Body Position Description	Diagrams	Major Desired Actions
1. Body extended with head, upper back, buttocks and heels at the surface of the water.		1. Gives the impression that the body is stretched horizontally to its maximum. Judgement made by checking visual points of the horizontal alignment: ears, shoulder joints, hip joints and heels.
2. Unless otherwise specified, face may be in or out of the water.		2. Once the head position is established as in or out of the water the position is maintained. When the face is out of the water the ears will not be on the horizontal axis and the back may be slightly lower and arched. Hip joints, calves and heels remain at the surface of the water.

BP 10 Front Pike Position


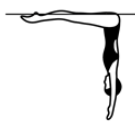
Body Position Description	Diagrams	Major Desired Actions
1. Body bent at hips to form a 90° angle.		1. Exact 90° angle.
2. Legs extended and together.		2. Full extension of legs, with ankles aligned with hip joints.

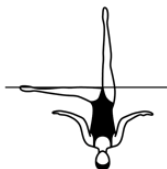
Figure – 346 SIDE FISHTAIL SPLIT (cont.)

DIFFICULTY – 2.0


BP 10 Front Pike Position (cont.)

Body Position Description	Diagrams	Major Desired Actions
3. Trunk extended with the back straight and head in line.		3. Back flat, with vertical alignment of ears, shoulder joints and hip joints once the position is established.

BP 19 Side Fishtail Position

Body Position Description	Diagrams	Major Desired Actions
1. Body extended in Vertical Position with one leg extended sideways with the foot at the surface of the water regardless of the height of the hips.		1. BP 6 Vertical Position alignment must be evident from a front or back view of the extended body. The head, trunk and extended leg face forward.

BP 16 Split Position

Body Position Description	Diagrams	Major Desired Actions
1. Legs evenly split forward and back. 2. The legs are parallel to the surface of the water. 3. Lower back arched, with hips, shoulders and head on a vertical line. 4. 180° angle between the extended legs (flat split), with inside of each leg aligned on opposite sides of a horizontal line, regardless of the height of the hips.		1. Full extension of the legs at or above the surface of the water. 4. Flat split. Hip joints and shoulder joints on a horizontal line, with both of these alignments 'square' and parallel to each other.

a) Surface Split Position

1. Legs are dry at the surface of the water.



1. Full extension of the legs. Crotch and legs dry at the surface of the water.

BP 6 Vertical Position


Body Position Description	Diagrams	Major Desired Actions
1. Body extended perpendicular to the surface of the water; legs together, head downward.		1. Full extension of the body.

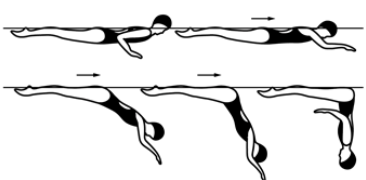
Figure – 346 SIDE FISHTAIL SPLIT (cont.)

DIFFICULTY – 2.0

BP 6 Vertical Position (cont.)

Body Position Description	Diagrams	Major Desired Actions
2. Head (ears specifically), hips and ankles in line.		2. Judgement is made by checking visual points of the vertical alignment: ears, shoulder joints, hip joints and ankles.

BM 3 To Assume a Front Pike Position/A Front Pike Position is assumed

Basic Movement Description	NVT	Diagrams	Major Desired Actions
1. From a Front Layout Position with the face in the water the trunk moves downward to assume a Front Pike Position . The buttocks, legs and feet travel along the surface of the water until the hips occupy the position of the head at the beginning of this action.	6.0		<p>1.1 See BP 2 Front Layout Position and BP 10 Front Pike Position. Uniform motion in downward movement of the trunk. The trunk remains straight throughout the movement. Hips and head lock into position simultaneously.</p> <p>1.2 Unless otherwise specified, <i>To Assume a Front Pike Position</i> starts from a Front Layout Position.</p>

BM 10 Vertical Descent

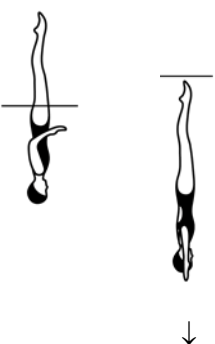
Basic Movement Description	NVT	Diagrams	Major Desired Actions
1. Maintaining a Vertical Position the body descends along its longitudinal axis until the toes are submerged.	14.0		1. See BP 6 Vertical Position . The tempo of the descent is uniform and at the same speed as the rest of the figure.

Figure – 347 MINERVA

DIFFICULTY – 2.0

From a **Front Layout Position** a *Front Pike Position* is assumed. One leg is lifted to vertical as the body rotates 90° on its longitudinal axis to assume a **Side Fishtail Position**. With continuous motion another 90° rotation is executed in the same direction as the vertical leg is lowered to assume a **Split Position**. During an additional 180° rotation in the same direction, the front leg is lifted to vertical as the back leg bends to an angle of 90° or less with the thigh and shin remaining at the surface of the water to assume a **Bent Knee Vertical Position**. A *Vertical Descent* is executed in a **Bent Knee Vertical Position**.







						Total
NVT=	6.0	23.0	22.0	10.0	61	
PV =	0.98	3.77	3.61	1.64	10	





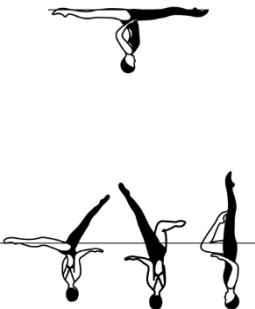

Figure Description	NVT	Diagrams	Major Desired Actions
1. From a Front Layout Position a <i>Front Pike Position</i> is assumed.	6.0	 	1. See BP 2 Front Layout , BP 10 Front Pike Position and BM 3 <i>To Assume a Front Pike Position</i> . Smooth even movement downwards of the trunk.
2. One leg is lifted to vertical as the body rotates 90° on its longitudinal axis to assume a Side Fishtail Position . With continuous motion another 90° rotation is executed in the same direction as the vertical leg is lowered to assume a Split Position .	23.0	 	2.1 Constant height and continuous motion as the body rotates simultaneously with the 180° leg arc over the surface of the water to BP 16a Surface Split Position . 2.2 BP 19 Side Fishtail Position must be clearly evident. There is no pause in this position as the leg passes through the mid-point of the 180° arc over the surface of the water. Vertical alignment of the trunk must be maintained throughout the rotation.

Figure – 347 MINERVA (cont.)

DIFFICULTY – 2.0

Figure Description	NVT	Diagrams	Major Desired Actions
<p>3. During an additional 180° rotation in the same direction, the front leg is lifted to vertical as the back leg bends to an angle of 90° or less with the thigh and shin remaining at the surface of the water to assume a Bent Knee Vertical Position.</p> <p>It is important to note that the front leg in the Split Position becomes the vertical leg in the Bent Knee Vertical Position.</p> <p>The diagram shows the Split Position to Bent Knee Vertical Position movement performed with the right (R) leg shaded black however either leg can be used to perform the action.</p>	22.0		<p>3. Sustained height and simultaneous movement of the legs to achieve BP 14c Bent Knee Vertical Position as the rotation is completed. During much of the bending action of the back leg, the inside of the shin and thigh faces upward.</p>
<p>4. A <i>Vertical Descent</i> is executed in a Bent Knee Vertical Position.</p>	10.0		<p>4. See BP 14c Bent Knee Vertical Position and BM 10 <i>Vertical Descent</i>. The vertical line is maintained throughout the descent.</p>

See Figure 346 Side Fishtail Split for **Front Layout Position, Front Pike Position, Side Fishtail Position, Split Position** and *To Assume a Front Pike Position Basic Movement*.

BP 14 Bent Knee Position


Body Position Description	Diagrams	Major Desired Actions
<p>One leg bent with the toe of the bent leg in contact with the inside of the extended leg at the knee or higher.</p>		<p>The relationship of the toe of the bent leg to the extended leg may vary depending on the figure but should remain constant once established, and not extend in front of or behind the extended leg.</p>
<p>c) Bent Knee Vertical Position</p> <p>1. Body extended in Vertical Position with the thigh of the bent leg parallel to the surface of the water.</p>		<p>1. In BP 6 Vertical Position the alignment of the extended leg, trunk and head remains constant.</p>

Figure – 347 MINERVA (cont.)

DIFFICULTY – 2.0

BM 10 Vertical Descent in Bent Knee Vertical

Basic Movement Description	NVT	Diagrams	Major Desired Actions
1. Maintaining a Bent Knee Vertical Position , the body descends along its longitudinal axis until the toes are submerged.	10.0		1. See BP 14c Bent Knee Vertical Position . 2. The tempo of the descent is uniform and at the same speed as the rest of the figure.

Figure – 348 TOWER

DIFFICULTY – 1.9



From a **Front Layout Position** a *Front Pike Position* is assumed. One leg is lifted to a **Fishtail Position**. The horizontal leg is lifted to a **Vertical Position**. A *Vertical Descent* is executed.

					Total
NVT=	6.0	14.5	20.5	14.0	55
PV =	1.09	2.64	3.73	2.55	10


Figure Description	NVT	Diagrams	Major Desired Actions
1. From a Front Layout Position a <i>Front Pike Position</i> is assumed.	6.0		1. See BP 2 Front Layout , BP 10 Front Pike Position and BM 3 <i>To Assume a Front Pike Position</i> . Smooth even movement downwards of the trunk.
2. One leg is lifted to a Fishtail Position .	14.5		2.1 See BP 8 Fishtail Position . Height and vertical alignment of the trunk maintained throughout. 2.2 The Fishtail Position is held only long enough to define the position and to demonstrate completion of the transition.

Figure – 348 TOWER (cont.)

DIFFICULTY – 1.9

Figure Description	NVT	Diagrams	Major Desired Actions
3. The horizontal leg is lifted to a Vertical Position .	20.5		3.1 See BP 6 Vertical Position . Height is constant as the legs join, with the trunk and the vertical leg maintaining vertical alignment throughout. 3.2 The Vertical Position is held only long enough to define the position and to demonstrate completion of the transition prior to descent.
4. A <i>Vertical Descent</i> is executed.	14.0		4. See BM 10 <i>Vertical Descent</i> .

BP 2 Front Layout Position

Body Position Description	Diagrams	Major Desired Actions
1. Body extended with head, upper back, buttocks and heels at the surface of the water.		1. Gives the impression that the body is stretched horizontally to its maximum. Judgement made by checking visual points of the horizontal alignment: ears, shoulder joints, hip joints and heels.
2. Unless otherwise specified, face may be in or out of the water.		2. Once the head position is established as in or out of the water the position is maintained. When the face is out of the water the ears will not be on the horizontal axis and the back may be slightly lower and arched. Hip joints, calves and heels remain at the surface of the water.

BP 10 Front Pike Position



Body Position Description	Diagrams	Major Desired Actions
1. Body bent at hips to form a 90° angle.		1. Exact 90° angle.

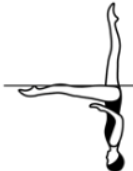
Figure – 348 TOWER (cont.)

DIFFICULTY – 2.0

BP 10 Front Pike Position (cont.)

Body Position Description	Diagrams	Major Desired Actions
2. Legs extended and together.		2. Full extension of legs, with ankles aligned with hip joints.
3. Trunk extended with the back straight and head in line.		3. Back flat, with vertical alignment of ears, shoulder joints and hip joints once the position is established.

BP 8 Fishtail Position

Body Position Description	Diagrams	Major Desired Actions
1. Body extended in Vertical Position with one leg extended forward. The foot of the forward leg is at the surface of the water regardless of the height of the hips.		1. See BP 6 Vertical Position for body alignment. The foot of the forward leg must be at the surface of the water. Hip joints must be on a horizontal line.

BP 6 Vertical Position


Body Position Description	Diagrams	Major Desired Actions
1. Body extended perpendicular to the surface of the water; legs together, head downward.		1. Full extension of the body.
2. Head (ears specifically), hips and ankles in line.		2. Judgement is made by checking visual points of the vertical alignment: ears, shoulder joints, hip joints and ankles.

Figure – 348 TOWER (cont.)

DIFFICULTY – 2.0

BM 3 To Assume a Front Pike Position/A Front Pike Position is assumed

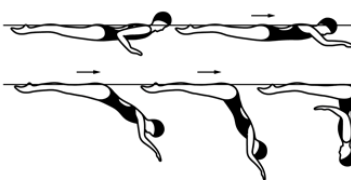
Basic Movement Description	NVT	Diagrams	Major Desired Actions
<p>1. From a Front Layout Position with the face in the water the trunk moves downward to assume a Front Pike Position. The buttocks, legs and feet travel along the surface of the water until the hips occupy the position of the head at the beginning of this action.</p>	<p>6.0</p>		<p>1.1 See BP 2 Front Layout Position and BP 10 Front Pike Position. Uniform motion in downward movement of the trunk. The trunk remains straight throughout the movement. Hips and head lock into position simultaneously.</p> <p>1.2 Unless otherwise specified, <i>To Assume a Front Pike Position</i> starts from a Front Layout Position.</p>

Figure – 348 TOWER (cont.)

DIFFICULTY – 2.0

BM 10 Vertical Descent

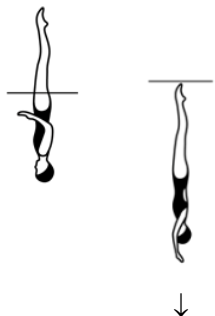
Basic Movement Description	NVT	Diagrams	Major Desired Actions
<p>1. Maintaining a Vertical Position the body descends along its longitudinal axis until the toes are submerged.</p>	<p>14.0</p>		<p>1. See BP 6 Vertical Position. The tempo of the descent is uniform and at the same speed as the rest of the figure.</p>

Figure – 349 BELUGA

DIFFICULTY – 2.1

From a **Front Layout Position** a *Front Pike Position* is assumed. One leg is lifted to a **Fishtail Position**. Maintaining the vertical alignment of the body, the foot of the horizontal leg is moved with accelerating speed in a horizontal arc of 180° at the surface of the water to a **Knight Position**. The vertical leg is lowered to a **Surface Arch Position** at the same tempo as the **Front Layout Position** to **Fishtail Position**. An *Arch to Back Layout Finish Action* is executed.







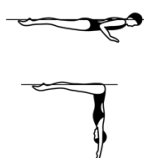
						Total
NVT=	6.0	14.5	21.0	18.5	7.0	67
PV =	0.90	2.16	3.13	2.76	1.04	10

Figure Description	NVT	Diagrams	Major Desired Actions
--------------------	-----	----------	-----------------------

1. From a **Front Layout Position** a *Front Pike Position* is assumed.

6.0



1. See BP 2 **Front Layout**, BP 10 **Front Pike Position** and BM 3 *To Assume a Front Pike Position*.
Smooth even movement downwards of the trunk.

2. One leg is lifted to a **Fishtail Position**.

14.5



2.1 See BP 8 **Fishtail Position**. Height and vertical alignment of the trunk maintained.
2.2 The **Fishtail Position** is held only long enough to define the position and to demonstrate completion of the transition.

3. Maintaining the vertical alignment of the body, the foot of the horizontal leg is moved with accelerating speed in a horizontal arc of 180° at the surface of the water to a **Knight Position**.

21.0





3. The vertical leg remains stationary and height remains constant throughout the rotation. The foot of the horizontal leg is at the surface of the water and not above or below. There is controlled acceleration and full extension of the horizontal leg throughout the 180° arcing action to BP 17 **Knight Position**.

It is important to note that the vertical leg in the **Fishtail Position** must become the vertical leg in the **Knight Position**.

The diagram shows the **Fishtail Position** to **Knight Position** movement performed with the left (L) leg shaded black however either leg can be used to perform the action.

Figure – 349 BELUGA (cont.)

DIFFICULTY – 2.1

Figure Description	NVT	Diagrams	Major Desired Actions
4. The vertical leg is lowered to a Surface Arch Position at the same tempo as the Front Layout Position to Fishtail Position .	18.5		<p>4.1 See BP 13 Surface Arch Position. Hip and shoulder joints remain on a horizontal line.</p> <p>4.2 Hip height remains constant and at the surface of the water.</p> <p>4.3 Both legs maintain full extension.</p> <p>4.4 The trunk remains stationary until the feet join.</p> <p>4.5 No pause in BP 13 Surface Arch Position however an accurate surface arch must be evident before BM 5 <i>Arch to Back Layout Finish Action</i> occurs.</p>
5. An <i>Arch to Back Layout Finish Action</i> is executed.	7.0		5. See BM 5 <i>Arch to Back Layout Action</i> .

See Figure 348 Tower for **Front Layout Position, Front Pike Position, Fishtail Position** and *To Assume A Front Pike Position Basic Movement*.

BP 17 Knight Position

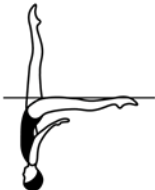
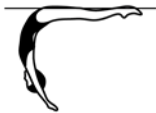
Body Position Description	Diagrams	Major Desired Actions
1. Lower back arched, with hips, shoulders and head on a vertical line.		1. Arch is in the lower part of the spine only.
2. One leg vertical.		2. Vertical alignment through ears, shoulder joints, hip joints and ankle of the vertical leg.
3. Other leg extended backward with the leg at the surface of the water and as close to horizontal as possible.		3. Hip joints and shoulder joints on a horizontal line with both of these alignments 'square' and parallel to each other. The top of the horizontal extended leg faces upward.


Figure – 349 BELUGA (cont.)

DIFFICULTY – 2.1

BP 13 Surface Arch Position

Body Position Description	Diagrams	Major Desired Actions
1. Lower back arched, with hips, shoulders and head on a vertical line.		1. Hip joints and shoulder joints on a horizontal line with both of these alignments 'square' and parallel to one another. Head (ears specifically) in line with shoulders.
2. Legs together and at the surface of the water.		2. Hips joints at the surface of the water.

BP 1 Back Layout Position

Body Position Description	Diagrams	Major Desired Actions
1. Body extended with face, chest, thighs and feet at the surface of the water.		1. Gives the impression that the body is stretched horizontally to its maximum. Front of the trunk will also be at the surface of the water.
2. Head (ears specifically), hips and ankles in horizontal alignment.		2. Judgement is made by checking visual points of the horizontal alignment: ears, shoulder joints, hip joints and ankles. This imaginary line should also pass through the middle of the side of the trunk.

BM 5 Arch to Back Layout Finish Action

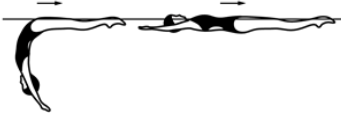
Basic Movement Description	NVT	Diagrams	Major Desired Actions
1. From a Surface Arch Position the hips, chest and face surface sequentially at the same point with foot first movement to a Back Layout Position until the head occupies the position of the hips at the beginning of this action.	7.0		1. See BP 13 Surface Arch Position . Sharp arch in the lower back. The body rises, straightens and moves along the surface of the water with a stationary BP 1 Back Layout Position achieved as the face surfaces. Full extension maintained throughout.

Figure – 350 DALECARLIA

DIFFICULTY – 2.6

From a **Front Layout Position** a *Front Pike Position* is assumed. One leg is lifted to a **Fishtail Position**. Maintaining the 90° angle between the legs, the horizontal leg moves to vertical as the vertical leg simultaneously moves to the surface of the water to assume a **Knight Position**. Without movement of the legs, the trunk straightens as it rises to a **Surface Ballet Leg Position**. The *Ballet Leg* is lowered.



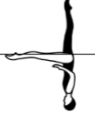




							Total
NVT=	6.0	14.5	31.0	22.0	11.0	10.5	95
PV =	0.63	1.53	3.26	2.32	1.16	1.11	10

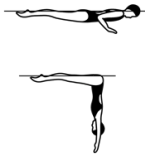


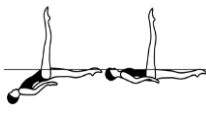




Figure Description	NVT	Diagrams	Major Desired Actions
1. From a Front Layout Position a <i>Front Pike Position</i> is assumed.	6.0		1. See BP 2 Front Layout , BP 10 Front Pike Position and BM 3 <i>To Assume a Front Pike Position</i> . Smooth even movement downwards of the trunk.
2. One leg is lifted to a Fishtail Position .	14.5		2.1 See BP 8 Fishtail Position . Height and vertical alignment of trunk maintained. 2.2 The Fishtail Position is held only long enough to define the position and to demonstrate completion of the transition.
3. Maintaining the 90° angle between the legs, the horizontal leg moves to vertical as the vertical leg simultaneously moves to the surface of the water to assume a Knight Position .	31.0		3.1 See BP 17 Knight Position . Height and vertical alignment of the trunk maintained as both legs move as a 'locked' unit to BP 17 Knight Position with the vertical leg reaching the surface of the water and the horizontal leg achieving vertical simultaneously. 3.2 90° angle between the legs is maintained throughout the transition. 3.3 Stability and control evident. 3.4 Height constant with hips as pivot point from the Fishtail Position to the Knight Position .
It is important to note that the vertical leg in the Fishtail Position must become the horizontal leg in the Knight Position .			
The diagram shows the Fishtail Position to Knight Position movement performed with the left (L) shaded black however either leg can be used to perform the action.			

Figure – 350 DALECARLIA (cont.)

DIFFICULTY – 2.6

Figure Description	NVT	Diagrams	Major Desired Actions
4. Without movement of the legs, the trunk straightens as it rises to a Surface Ballet Leg Position .	22.0		4. See BP 3a Surface Ballet Leg Position . Hip height and leg alignment remain constant.
5. The <i>Ballet Leg is lowered</i> .	11.0		5. See BM 2 <i>The Ballet Leg is lowered</i> .
	10.5		

BP 2 Front Layout Position

Body Position Description	Diagrams	Major Desired Actions
1. Body extended with head, upper back, buttocks and heels at the surface of the water.		1. Gives the impression that the body is stretched horizontally to its maximum. Judgement made by checking visual points of the horizontal alignment: ears, shoulder joints, hip joints and heels.
2. Unless otherwise specified, face may be in or out of the water.		2. Once the head position is established as in or out of the water the position is maintained. When the face is out of the water the ears will not be on the horizontal axis and the back may be slightly lower and arched. Hip joints, calves and heels remain at the surface of the water.

BP 10 Front Pike Position


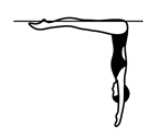

Body Position Description	Diagrams	Major Desired Actions
1. Body bent at hips to form a 90° angle.		1. Exact 90° angle.
2. Legs extended and together.		2. Full extension of legs, with ankles aligned with hip joints.
3. Trunk extended with the back straight and head in line.		3. Back flat, with vertical alignment of ears, shoulder joints and hip joints once the position is established.

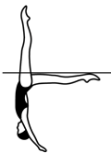
Figure – 350 DALECARLIA (cont.)

DIFFICULTY – 2.6

BP 8 Fishtail Position

Body Position Description	Diagrams	Major Desired Actions
<p>1. Body extended in Vertical Position with one leg extended forward. The foot of the forward leg is at the surface of the water regardless of the height of the hips.</p>		<p>1. See BP 6 Vertical Position for body alignment. The foot of the forward leg must be at the surface of the water. Hip joints must be on a horizontal line.</p>

BP 17 Knight Position

Body Position Description	Diagrams	Major Desired Actions
<p>1. Lower back arched, with hips, shoulders and head on a vertical line.</p>		<p>1. Arch is in the lower part of the spine only.</p>
<p>2. One leg vertical.</p>		<p>2. Vertical alignment through ears, shoulder joints, hip joints and ankle of the vertical leg.</p>
<p>3. Other leg extended backward with the leg at the surface of the water and as close to horizontal as possible.</p>		<p>3. Hip joints and shoulder joints on a horizontal line with both of these alignments 'square' and parallel to each other. The top of the horizontal extended leg faces upward.</p>

BP 3 Ballet Leg Position


Body Position Description	Diagrams	Major Desired Actions
<p>a) Surface</p> <p>1. Body in Back Layout Position.</p>		<p>1. See BP 1 Back Layout Position. Ears, shoulder joints, hip joints and ankle of extended leg in line at maximum horizontal alignment.</p>
<p>2. One leg extended perpendicular to the surface of the water.</p>		<p>2. 90° angle between the extended leg and the surface of the water and between the extended leg and the trunk with maximum horizontal alignment maintained throughout.</p>

Figure – 350 DALECARLIA (cont.)

DIFFICULTY – 2.6

BP 14 Bent Knee Position

Body Position Description	Diagrams	Major Desired Actions
One leg bent with the toe of the bent leg in contact with the inside of the extended leg at the knee or higher.		The relationship of the toe of the bent leg to the extended leg may vary depending on the figure but should remain constant once established, and not extend in front of or behind the extended leg.

b) Bent Knee Back Layout Position

1. Body extended in **Back Layout Position**.



1. In BP 1 **Back Layout Position** ears, shoulder joints, hip joints and ankle of extended leg in line at maximum horizontal alignment.

2. The thigh of the bent leg is perpendicular to the surface of the water.

2. 90° angle between the thigh and the surface of the water, and 90° angle maintained between the thigh and the trunk. At maximum height an air pocket will be evident between the back of the thigh and calf of the bent leg and the surface of the water.

BP 1 Back Layout Position


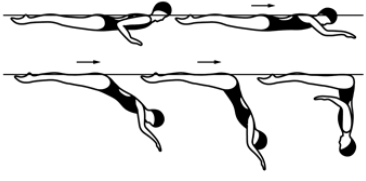
Body Position Description	Diagrams	Major Desired Actions
1. Body extended with face, chest, thighs and feet at the surface of the water.		1. Gives the impression that the body is stretched horizontally to its maximum. Front of the trunk will also be at the surface of the water.
2. Head (ears specifically), hips and ankles in horizontal alignment.		2. Judgement is made by checking visual points of the horizontal alignment: ears, shoulder joints, hip joints and ankles. This imaginary line should also pass through the middle of the side of the trunk.

Figure – 350 DALECARLIA (cont.)

DIFFICULTY – 2.6

BM 3 To Assume a Front Pike Position/A Front Pike Position is assumed

Basic Movement Description	NVT	Diagrams	Major Desired Actions
<p>1. From a Front Layout Position with the face in the water the trunk moves downward to assume a Front Pike Position. The buttocks, legs and feet travel along the surface of the water until the hips occupy the position of the head at the beginning of this action.</p>	6.0		<p>1.1 See BP 2 Front Layout Position and BP 10 Front Pike Position. Uniform motion in downward movement of the trunk. The trunk remains straight throughout the movement. Hips and head lock into position simultaneously.</p> <p>1.2 Unless otherwise specified, <i>To Assume a Front Pike Position</i> starts from a Front Layout Position.</p>

BM 2 To Lower a Ballet Leg/A Ballet Leg is lowered




Basic Movement Description	NVT	Diagrams	Major Desired Actions
<p>1. From a Ballet Leg Position the ballet leg is bent without movement of the thigh to a Bent Knee Back Layout Position.</p>			<p>1. See BP 3a Surface Ballet Leg Position and BP 14b Bent Knee Back Layout Position. The height remains constant throughout the movement.</p>
<p>2. The toe moves along the inside of the extended leg until a Back Layout Position is assumed.</p>	11.0		<p>2.1 Full extension in BP 1 Back Layout Position to be achieved as the feet are joined.</p>
	10.5		<p>2.2 The head and trunk remain stationary throughout.</p>

Figure – 351 JUPITER

DIFFICULTY – 2.8

From a **Front Layout Position** a *Front Pike Position* is assumed. One leg is lifted to a **Fishtail Position**. Maintaining the 90 ° angle between the legs, the horizontal leg moves to vertical as the vertical leg simultaneously moves to the surface of the water to assume a **Knight Position**. Maintaining the vertical alignment of the body, the horizontal leg is moved in a 180° arc at the surface of the water to a **Fishtail Position**. The horizontal leg is lifted to the **Vertical Position**. A *Vertical Descent* is executed.




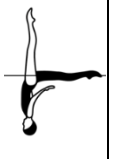

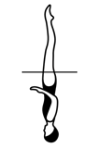

							Total
NVT=	6.0	14.5	31.0	18.0	20.5	14.0	104
PV =	0.58	1.39	2.98	1.73	1.97	1.35	10




Figure Description	NVT	Diagrams	Major Desired Actions
1. From a Front Layout Position a <i>Front Pike Position</i> is assumed.	6.0	 	1. See BP 2 Front Layout , BP 10 Front Pike Position and BM 3 <i>To Assume a Front Pike Position</i> . Smooth even movement downwards of the trunk.
2. One leg is lifted to a Fishtail Position .	14.5		2.1 See BP 8 Fishtail Position . Height and vertical alignment of the trunk is maintained. 2.2 The Fishtail Position is held only long enough to define the position and to demonstrate completion of the transition.

Figure – 351 JUPITER (cont.)

DIFFICULTY – 2.8





Figure Description	NVT	Diagrams	Major Desired Actions
<p>3. Maintaining the 90° angle between the legs, the horizontal leg moves to vertical as the vertical leg simultaneously moves to the surface of the water to assume a Knight Position.</p> <p>It is important to note that the vertical leg in the Fishtail Position must become the horizontal leg in the Knight Position.</p> <p>The diagram shows the Fishtail Position to the Knight Position movement performed with the left (L) leg shaded black however either leg can be used to perform the action.</p>	31.0		<p>3.1 See BP 17 Knight Position. Height and vertical alignment of the trunk maintained as both legs move as a 'locked' unit to BP 17 Knight Position with the vertical leg reaching the surface of the water and the horizontal leg achieving vertical simultaneously.</p> <p>3.2 90° angle between the legs is maintained throughout the transition.</p> <p>3.3 The Knight Position is held only long enough to define the position and to demonstrate completion of the transition.</p> <p>3.4 Height constant with hips as pivot point from the Fishtail Position to the Knight Position.</p>
<p>4. Maintaining the vertical alignment of the body, the horizontal leg is moved in a 180° arc at the surface of the water to a Fishtail Position</p>	18.0		<p>.1 See BP 8 Fishtail Position. The vertical leg remains stationary and height remains constant throughout the rotation.</p> <p>4.2 The foot of the horizontal leg is at the surface of the water and not above or below.</p> <p>4.3 There is full extension of the horizontal leg throughout the 180° arcing of the horizontal leg at the surface of the water to Fishtail Position.</p>

Figure – 351 JUPITER (cont.)

DIFFICULTY – 2.8

Figure Description	NVT	Diagrams	Major Desired Actions
5. The horizontal leg is lifted to the Vertical Position .	20.5		5.1 See BP 6 Vertical Position . Height is constant as the legs join, with the trunk and the vertical leg maintaining vertical alignment. 5.2 The Vertical Position is held only long enough to define the position and to demonstrate completion of the transition.
6. A <i>Vertical Descent</i> is executed.	14.0		4. See BM 10 <i>Vertical Descent</i> .

See Figure 350 Dalecarlia for **Front Layout Position, Front Pike Position, Fishtail Position, Knight Position** and *To Assume A Front Pike Position Basic Movement*.

BP 6 Vertical Position


Body Position Description	Diagrams	Major Desired Actions
1. Body extended perpendicular to the surface of the water; legs together, head downward.		1. Full extension of the body.
2. Head (ears specifically), hips and ankles in line.		2. Judgement is made by checking visual points of the vertical alignment: ears, shoulder joints, hip joints and ankles.

Figure – 351 JUPITER (cont.)

DIFFICULTY – 2.8

BM 10 Vertical Descent

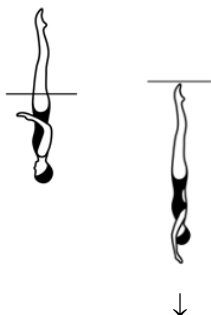
Basic Movement Description	NVT	Diagrams	Major Desired Actions
<p>1. Maintaining a Vertical Position the body descends along its longitudinal axis until the toes are submerged.</p>	<p>14.0</p>		<p>1. See BP 6 Vertical Position. The tempo of the descent is uniform and at the same speed as the rest of the figure.</p>

Figure – 352 VENUS

DIFFICULTY – 3.0

From a **Front Layout Position** a *Front Pike Position* is assumed. All remaining movements are performed rapidly. One leg is lifted to a **Fishtail Position**. The horizontal leg is bent to assume a **Bent Knee Vertical Position**. The bent leg is extended to vertical as the vertical leg is lowered to become the horizontal leg in **Fishtail Position**. A rotation of 360° is executed in the **Fishtail Position**. The horizontal leg is lifted to **Vertical Position**. A 360° *Spin* is executed.











										Total
NVT=	6.0	12.5	12.5	18.5	24.0		20.5	23.0	0	117
PV =	0.51	1.07	1.07	1.58	2.05		1.75	1.97	0	10





Figure Description	NVT	Diagrams	Major Desired Actions
<p>1. From a Front Layout Position a <i>Front Pike Position</i> is assumed.</p>	6.0	 	<p>1. See BP 2 Front Layout, BP 10 Front Pike Position and BM 3 <i>To Assume a Front Pike Position</i>. Smooth even movement downwards of the trunk.</p>
<p>2. One leg is lifted to a Fishtail Position. The horizontal leg is bent to assume a Bent Knee Vertical Position.</p> <p>It is important to note that the vertical leg in the Fishtail Position must remain the vertical leg in the Bent Knee Vertical Position.</p> <p>The diagram shows the Fishtail Position to Bent Knee Vertical Position movement performed with the left (L) leg shaded black however either leg can be used to perform the action.</p>	12.5 12.5	 	<p>2.1 This action is performed rapidly. 2.2 See BP 8 Fishtail Position. A clear Fishtail Position is shown. 2.3 Height and vertical alignment of the trunk is maintained. 2.4 See BP 14c Bent Knee Vertical Position. Height, stability and vertical body alignment maintained throughout the bending of the horizontal leg to assume a Bent Knee Vertical Position.</p>

Figure – 352 VENUS (cont.)

DIFFICULTY – 3.0








Figure Description	NVT	Diagrams	Major Desired Actions
<p>3. The bent leg is extended to vertical as the vertical leg is lowered to become the horizontal leg in Fishtail Position. It is important to note that the vertical leg in the Bent Knee Vertical Position becomes the horizontal leg in the Fishtail Position.</p> <p>The diagram shows the Bent Knee Vertical Position to the Fishtail Position movement performed with the left (L) leg shaded black however either leg can be used to perform the action.</p>	18.5	 	<p>3.1 This action is performed rapidly. 3.2 See BP 14c Bent Knee Vertical Position and BP 8 Fishtail Position. A clear Bent Knee Vertical Position is shown prior to the Fishtail Position. 3.3 Both legs should move simultaneously to assume a Fishtail Position with height and vertical alignment of the trunk maintained throughout</p>
<p>4. A rotation of 360° is executed in the Fishtail Position.</p>	24.0	 	<p>4.1 This action is performed rapidly. 4.2 See BP 8 Fishtail Position. The vertical leg remains stationary and height remains constant throughout the rapid rotation. 4.3 The foot of the horizontal leg is at the surface of the water and not above or below. 4.4 There is full extension of the horizontal leg throughout the 360° rotation in BP 8 Fishtail Position.</p>
<p>5. The horizontal leg is lifted to Vertical Position.</p>	20.5		<p>5.1 This action is performed rapidly. 5.2 See BP 8 Fishtail Position. The horizontal leg is lifted to BP 6 Vertical Position with height and vertical alignment of the trunk maintained throughout. 5.3 The Vertical Position is held only long enough to define the position and to demonstrate completion of the transition.</p>



Figure – 352 VENUS (cont.)

DIFFICULTY – 3.0

Figure Description	NVT	Diagrams	Major Desired Actions
6. A 360° Spin is executed.	23.0		6.1 This action is performed rapidly. 6.2 See BM 13 Spins and Spin Allowances.
	0		

Note: Refer to Section BM 13 Spins & Spin Allowances

BP 2 Front Layout Position

Body Position Description	Diagrams	Major Desired Actions
1. Body extended with head, upper back, buttocks and heels at the surface of the water.		1. Gives the impression that the body is stretched horizontally to its maximum. Judgement made by checking visual points of the horizontal alignment: ears, shoulder joints, hip joints and heels.
2. Unless otherwise specified, face may be in or out of the water.		2. Once the head position is established as in or out of the water the position is maintained. When the face is out of the water the ears will not be on the horizontal axis and the back may be slightly lower and arched. Hip joints, calves and heels remain at the surface of the water.

BP 10 Front Pike Position




Body Position Description	Diagrams	Major Desired Actions
1. Body bent at hips to form a 90° angle.		1. Exact 90° angle.
2. Legs extended and together.		2. Full extension of legs, with ankles aligned with hip joints.
3. Trunk extended with the back straight and head in line.		3. Back flat, with vertical alignment of ears, shoulder joints and hip joints once the position is established.


Figure – 352 VENUS (cont.)

DIFFICULTY – 3.0

BP 8 Fishtail Position

Body Position Description	Diagrams	Major Desired Actions
<p>1. Body extended in Vertical Position with one leg extended forward. The foot of the forward leg is at the surface of the water regardless of the height of the hips.</p>		<p>1. See BP 6 Vertical Position for body alignment. The foot of the forward leg must be at the surface of the water. Hip joints must be on a horizontal line.</p>

BP 14 Bent Knee Position

Body Position Description	Diagrams	Major Desired Actions
<p>One leg bent with the toe of the bent leg in contact with the inside of the extended leg at the knee or higher.</p>		<p>The relationship of the toe of the bent leg to the extended leg may vary depending on the figure but should remain constant once established, and not extend in front of or behind the extended leg.</p>
<p>c) Bent Knee Vertical Position</p>		
<p>1. Body extended in Vertical Position with the thigh of the bent leg parallel to the surface of the water.</p>		<p>1. In BP 6 Vertical Position the alignment of the extended leg, trunk and head remains constant.</p>

BP 6 Vertical Position


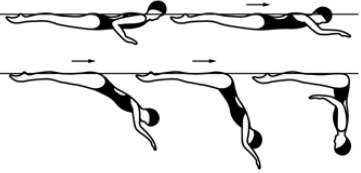
Body Position Description	Diagrams	Major Desired Actions
<p>1. Body extended perpendicular to the surface of the water; legs together, head downward.</p>		<p>1. Full extension of the body.</p>
<p>2. Head (ears specifically), hips and ankles in line.</p>		<p>2. Judgement is made by checking visual points of the vertical alignment: ears, shoulder joints, hip joints and ankles.</p>

Figure – 352 VENUS (cont.)

DIFFICULTY – 3.0

BM 3 To Assume a Front Pike Position/A Front Pike Position is assumed

Basic Movement Description	NVT	Diagrams	Major Desired Actions
<p>1. From a Front Layout Position with the face in the water the trunk moves downward to assume a Front Pike Position. The buttocks, legs and feet travel along the surface of the water until the hips occupy the position of the head at the beginning of this action.</p>	<p>6.0</p>		<p>1.1 See BP 2 Front Layout Position and BP 10 Front Pike Position. Uniform motion in downward movement of the trunk. The trunk remains straight throughout the movement. Hips and head lock into position simultaneously.</p> <p>1.2 Unless otherwise specified, <i>To Assume a Front Pike Position</i> starts from a Front Layout Position.</p>

BM 10 Vertical Descent - from ankle level

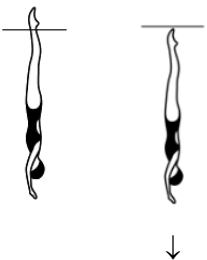
Basic Movement Description	NVT	Diagrams	Major Desired Actions
<p>1. Maintaining a Vertical Position the body descends along its longitudinal axis until the toes are submerged.</p>	<p>0</p>		<p>1. See BP 6 Vertical Position. The tempo of the descent is uniform and rapid.</p>

Figure – 355 PORPOISE

DIFFICULTY – 1.8

From a **Front Layout Position** a *Front Pike Position* is assumed. The legs are lifted to **Vertical Position**. A *Vertical Descent* is executed.





				Total
NVT=	6.0	33.0	14.0	53
PV =	1.13	6.23	2.64	10

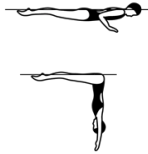
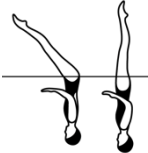



Figure Description	NVT	Diagrams	Major Desired Actions
1. From a Front Layout Position a <i>Front Pike Position</i> is assumed.	6.0		1. See BP 2 Front Layout , BP 10 Front Pike Position and BM 3 <i>To Assume a Front Pike Position</i> . Smooth even movement downwards of the trunk.
2. The legs are lifted to a Vertical Position .	33.0		2.1 See BP 6 Vertical Position . The trunk remains on the vertical line as the legs are lifted. 2.2 Maximum height and Vertical Position achieved simultaneously. 2.3 The Vertical Position is held only long enough to define the position and to demonstrate completion of the transition.
3. A <i>Vertical Descent</i> is executed.	14.0		3. See BM 10 <i>Vertical Descent</i> . The tempo of the descent is uniform and at the same speed as the rest of the figure.

Figure – 355 PORPOISE (cont.)

DIFFICULTY – 1.8

BP 2 Front Layout Position

Body Position Description	Diagrams	Major Desired Actions
1. Body extended with head, upper back, buttocks and heels at the surface of the water.		1. Gives the impression that the body is stretched horizontally to its maximum. Judgement made by checking visual points of the horizontal alignment: ears, shoulder joints, hip joints and heels.
2. Unless otherwise specified, face may be in or out of the water.		2. Once the head position is established as in or out of the water the position is maintained. When the face is out of the water the ears will not be on the horizontal axis and the back may be slightly lower and arched. Hip joints, calves and heels remain at the surface of the water.

BP 10 Front Pike Position




Body Position Description	Diagrams	Major Desired Actions
1. Body bent at hips to form a 90° angle.		1. Exact 90° angle.
2. Legs extended and together.		2. Full extension of legs, with ankles aligned with hip joints.
3. Trunk extended with the back straight and head in line.		3. Back flat, with vertical alignment of ears, shoulder joints and hip joints once the position is established.

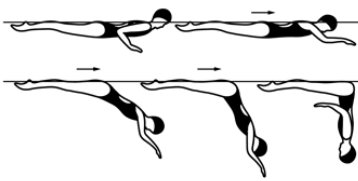
Figure – 355 PORPOISE (cont.)

DIFFICULTY – 1.8

BP 6 Vertical Position

Body Position Description	Diagrams	Major Desired Actions
1. Body extended perpendicular to the surface of the water; legs together, head downward.		1. Full extension of the body.
2. Head (ears specifically), hips and ankles in line.		2. Judgement is made by checking visual points of the vertical alignment: ears, shoulder joints, hip joints and ankles.

BM 3 To Assume a Front Pike Position/A Front Pike Position is assumed

Basic Movement Description	NVT	Diagrams	Major Desired Actions
1. From a Front Layout Position with the face in the water the trunk moves downward to assume a Front Pike Position . The buttocks, legs and feet travel along the surface of the water until the hips occupy the position of the head at the beginning of this action.	6.0		1.1 See BP 2 Front Layout Position and BP 10 Front Pike Position . Uniform motion in downward movement of the trunk. The trunk remains straight throughout the movement. Hips and head lock into position simultaneously. 1.2 Unless otherwise specified, <i>To Assume a Front Pike Position</i> starts from a Front Layout Position .

BM 10 Vertical Descent

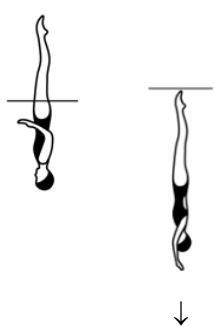
Basic Movement Description	NVT	Diagrams	Major Desired Actions
1. Maintaining a Vertical Position the body descends along its longitudinal axis until the toes are submerged.	14.0		1. See BP 6 Vertical Position . The tempo of the descent is uniform and at the same speed as the rest of the figure.

Figure – 355 PORPOISE (cont.)

Porpoise 355a – 355g, 355j – A Porpoise is executed to **Vertical Position**. The designated *Twist* or *Spin* is executed.

Note: Refer to Section BM 12 Twists & Twist Allowances and Section BM 13 Spins and Spin Allowances.

Figure – 355a PORPOISE ½ TWIST

DIFFICULTY – 2.2






					Total
NVT=	6.0	33.0	21.0	14.0	74
PV =	0.81	4.46	2.84	1.89	10

Figure – 355b PORPOISE FULL TWIST

DIFFICULTY – 2.4






					Total
NVT=	6.0	33.0	32.0	14.0	85
PV =	0.71	3.88	3.76	1.65	10

Figure – 355c PORPOISE TWIRL

DIFFICULTY – 2.3






					Total
NVT=	6.0	33.0	26.0	14.0	79
PV =	0.76	4.18	3.29	1.77	10

Figure – 355 PORPOISE (cont.)

Porpoise 355a – 355g, 355j – A Porpoise is executed to **Vertical Position**. The designated *Twist* or *Spin* is executed.

Note: Refer to Section BM 12 Twists & Twist Allowances and Section BM 13 Spins and Spin Allowances.

Figure – 355d PORPOISE SPINNING 180°
DIFFICULTY – 1.9






					Total
NVT=	6.0	33.0	16.0	0	55
PV =	1.09	6.00	2.91	0	10

Figure – 355e PORPOISE SPINNING 360°
DIFFICULTY – 1.9






					Total
NVT=	6.0	33.0	19.0	0	58
PV =	1.03	5.69	3.28	0	10

Figure – 355f PORPOISE CONTINUOUS SPIN (720°)
DIFFICULTY – 2.2





				Total
NVT=	6.0	33.0	34.0	73
PV =	0.82	4.52	4.66	10

Figure – 355 PORPOISE (cont.)

Porpoise 355a – 355g, 355j – A Porpoise is executed to **Vertical Position**. The designated *Twist* or *Spin* is executed.

Note: Refer to Section BM 12 Twists & Twist Allowances and Section BM 13 Spins and Spin Allowances.

Figure – 355g PORPOISE TWIST SPIN

DIFFICULTY – 2.5











					Total
NVT=	6.0	33.0	48.0	87	
PV =	0.69	3.79	5.52	10	

Figure – 355j PORPOISE COMBINED SPIN (360° + 360°)*

DIFFICULTY – 2.6

						Total
NVT=	6.0	33.0	40.0	14.0	93	
PV =	0.65	3.55	4.30	1.51	10	

* **Note: Refer to Section BM 13 Spins. There is no Spin Allowance for Combined Spins.**

Porpoise 355h and 355i – A Porpoise is executed to **Vertical Position**. A *Vertical Descent* is executed to ankle level. The designated *ascending Spin* is performed.

Note: Refer to Section BM 13 Spins & Spin Allowances

Figure – 355h PORPOISE SPIN UP 180°

DIFFICULTY – 2.5


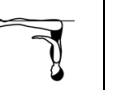
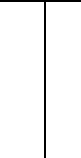
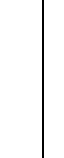


						Total
NVT=	6.0	33.0	14.0	20.0	14.0	87
PV =	0.69	3.79	1.61	2.30	1.61	10

Figure – 355 PORPOISE (cont.)

Porpoise 355h and 355i – A Porpoise is executed to **Vertical Position**. A *Vertical Descent* is executed to ankle level. The designated *ascending Spin* is performed.

Note: Refer to Section BM 13 Spins and Spin Allowances.

Figure – 355i PORPOISE SPIN UP 360°

DIFFICULTY – 2.5







						Total
NVT=	6.0	33.0	14.0	21.0	14.0	88
PV =	0.68	3.75	1.59	2.39	1.59	10

Figure – 356 WHIP

DIFFICULTY – 2.6

From a **Front Layout Position** a *Front Pike Position* is assumed. The legs are lifted to **Vertical Position**. All remaining movements are performed rapidly. One leg is lowered to a **Fishtail Position** and without a pause is lifted to a **Vertical Position**. A *Vertical Descent* is executed.







						Total
NVT=	6.0	33.0	22.5	20.5	14.0	96
PV =	0.63	3.44	2.34	2.14	1.46	10

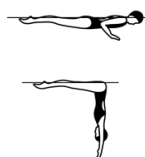
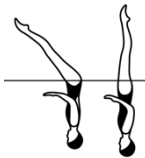





Figure Description	NVT	Diagrams	Major Desired Actions
1. From a Front Layout Position a <i>Front Pike Position</i> is assumed.	6.0		1. See BP 2 Front Layout , BP 10 Front Pike Position and BM 3 <i>To Assume a Front Pike Position</i> . Smooth even movement downwards of the trunk.
2. The legs are lifted to a Vertical Position .	33.0		2.1 See BP 6 Vertical Position . The trunk remains on the vertical line as the legs are lifted. 2.2 Maximum height and Vertical Position achieved simultaneously. The Vertical Position is held only long enough to define the position and to demonstrate completion of the transition.
3. One leg is lowered to a Fishtail Position and without a pause is lifted to a Vertical Position .	22.5		3.1 This action is performed rapidly. See BP 8 Fishtail Position .
	20.5		3.2 Height is constant as one leg is lowered and then lifted with the trunk and the vertical leg each maintaining vertical alignment.

Figure – 356 WHIP (cont.)

DIFFICULTY – 2.6

Figure Description	NVT	Diagrams	Major Desired Actions
4. A <i>Vertical Descent</i> is executed.	14.0		4. See BM 10 <i>Vertical Descent</i> . The tempo of the descent is uniform and rapid.

BP 2 Front Layout Position

Body Position Description	Diagrams	Major Desired Actions
1. Body extended with head, upper back, buttocks and heels at the surface of the water.		1. Gives the impression that the body is stretched horizontally to its maximum. Judgement made by checking visual points of the horizontal alignment: ears, shoulder joints, hip joints and heels.
2. Unless otherwise specified, face may be in or out of the water.		2. Once the head position is established as in or out of the water the position is maintained. When the face is out of the water the ears will not be on the horizontal axis and the back may be slightly lower and arched. Hip joints, calves and heels remain at the surface of the water.

BP 10 Front Pike Position




Body Position Description	Diagrams	Major Desired Actions
1. Body bent at hips to form a 90° angle.		1. Exact 90° angle.
2. Legs extended and together.		2. Full extension of legs, with ankles aligned with hip joints.
3. Trunk extended with the back straight and head in line.		3. Back flat, with vertical alignment of ears, shoulder joints and hip joints once the position is established.

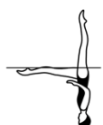
Figure – 356 WHIP (cont.)

DIFFICULTY – 2.6

BP 6 Vertical Position

Body Position Description	Diagrams	Major Desired Actions
1. Body extended perpendicular to the surface of the water; legs together, head downward.		1. Full extension of the body.
2. Head (ears specifically), hips and ankles in line.		2. Judgement is made by checking visual points of the vertical alignment: ears, shoulder joints, hip joints and ankles.

BP 8 Fishtail Position

Body Position Description	Diagrams	Major Desired Actions
1. Body extended in Vertical Position with one leg extended forward. The foot of the forward leg is at the surface of the water regardless of the height of the hips.		1. See BP 6 Vertical Position for body alignment. The foot of the forward leg must be at the surface of the water. Hip joints must be on a horizontal line.

BM 3 To Assume a Front Pike Position/A Front Pike Position is assumed

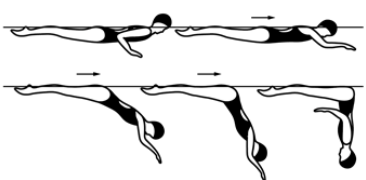
Basic Movement Description	NVT	Diagrams	Major Desired Actions
1. From a Front Layout Position with the face in the water the trunk moves downward to assume a Front Pike Position . The buttocks, legs and feet travel along the surface of the water until the hips occupy the position of the head at the beginning of this action.	6.0		1.1 See BP 2 Front Layout Position and BP 10 Front Pike Position . Uniform motion in downward movement of the trunk. The trunk remains straight throughout the movement. Hips and head lock into position simultaneously. 1.2 Unless otherwise specified, <i>To Assume a Front Pike Position</i> starts from a Front Layout Position .

Figure – 356 WHIP (cont.)

DIFFICULTY – 2.6

BM 10 Vertical Descent

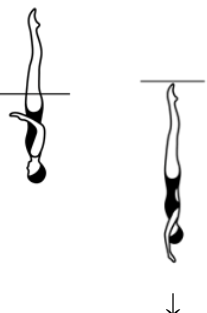
Basic Movement Description	NVT	Diagrams	Major Desired Actions
1. Maintaining a Vertical Position the body descends along its longitudinal axis until the toes are submerged.	14.0		1. See BP 6 Vertical Position . The tempo of the descent is uniform and rapid.

Figure – 356f WHIP CONTINUOUS SPIN (720°)

DIFFICULTY – 3.0

From a **Front Layout Position** a *Front Pike Position* is assumed. The legs are lifted to **Vertical Position**. All remaining movements are performed rapidly. One leg is lowered to a **Fishtail Position** and without a pause is lifted to a **Vertical Position**. Without a pause a *Continuous Spin 720°* is executed.

Note: Refer to Section BM 13 Spins and Spin Allowances.




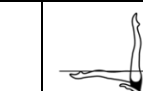
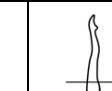

						Total
NVT=	6.0	33.0	22.5	20.5	34.0	116
PV =	0.52	2.84	1.94	1.77	2.93	10

Figure – 359 FRONT ARIANA

DIFFICULTY – 2.2

From a **Front Layout Position** a *Front Pike Position* is assumed. One leg is lifted in a 180° arc over the surface of the water to a **Split Position**. Maintaining the relative position of the legs to the surface of the water, an *Ariana Rotation* is performed. A *Walkout Front* is executed.







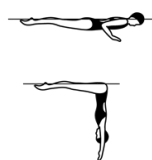
						Total
NVT	6.0	20.0	17.0	23.0	7.0	73
PVT	0.82	2.74	2.33	3.15	0.96	10

Figure Description	NVT	Diagrams	Major Desired Actions
--------------------	-----	----------	-----------------------

1. From a **Front Layout Position** a *Front Pike Position* is assumed.

6.0



1. See BP 2 **Front Layout**, BP 10 **Front Pike Position** and BM 3 *To Assume a Front Pike Position*.
Smooth even movement downwards of the trunk.

2. One leg is lifted in a 180° arc over the surface of the water to a **Split Position**.

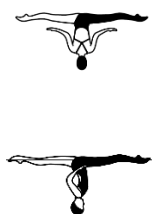
20.0



2.1 See 16a **Surface Split Position**. Constant height and continuous uniform motion to achieve BP 16a **Surface Split Position**.
2.2 Trunk maintains its vertical alignment, with hips and shoulders 'square'.
2.3 Full extension of the horizontal leg at the surface of the water.

3. Maintaining the relative position of the legs to the surface of the water, an *Ariana Rotation* is performed.

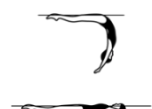
17.0



3. See BP 16a **Surface Split Position** and BM 16 *Ariana Rotation*. The trunk turns 180° around its longitudinal axis, while the legs rotate horizontally at the surface of the water, with full extension of the legs maintained throughout.

4. A *Walkout Front* is executed.

23.0





See BM 6a *Walkout Front* and BM 5 *Arch to Back Layout Action*.

7.0



Figure – 359 FRONT ARIANA (cont.)

DIFFICULTY – 2.2

BP 2 Front Layout Position

Body Position Description	Diagrams	Major Desired Actions
1. Body extended with head, upper back, buttocks and heels at the surface of the water.		1. Gives the impression that the body is stretched horizontally to its maximum. Judgement made by checking visual points of the horizontal alignment: ears, shoulder joints, hip joints and heels.
2. Unless otherwise specified, face may be in or out of the water.		2. Once the head position is established as in or out of the water the position is maintained. When the face is out of the water the ears will not be on the horizontal axis and the back may be slightly lower and arched. Hip joints, calves and heels remain at the surface of the water.

BP 10 Front Pike Position

Body Position Description	Diagrams	Major Desired Actions
1. Body bent at hips to form a 90° angle.		1. Exact 90° angle.
2. Legs extended and together.		2. Full extension of legs, with ankles aligned with hip joints.
3. Trunk extended with the back straight and head in line.		3. Back flat, with vertical alignment of ears, shoulder joints and hip joints once the position is established.



BP 16 Split Position

Body Position Description	Diagrams	Major Desired Actions
1. Legs evenly split forward and back. 2. The legs are parallel to the surface of the water. 3. Lower back arched, with hips, shoulders and head on a vertical line.		1. Full extension of the legs at or above the surface of the water.


Figure – 359 FRONT ARIANA (cont.)

DIFFICULTY – 2.2

BP 16 Split Position (cont.)

Body Position Description	Diagrams	Major Desired Actions
<p>4. 180° angle between the extended legs (flat split), with inside of each leg aligned on opposite sides of a horizontal line, regardless of the height of the hips.</p>		<p>4. Flat split. Hip joints and shoulder joints on a horizontal line, with both of these alignments 'square' and parallel to each other.</p>
<p>a) Surface Split Position 1. Legs are dry at the surface of the water.</p>		<p>1. Full extension of the legs. Crotch and legs dry at the surface of the water.</p>

BP 13 Surface Arch Position

Body Position Description	Diagrams	Major Desired Actions
<p>1. Lower back arched with hips, shoulders and head on a vertical line.</p>		<p>1. Hip joints and shoulder joints on a horizontal line with both of these alignments 'square' and parallel to one another. Head (ears specifically) in line with shoulders.</p>
<p>2. Legs together and at the surface of the water.</p>		<p>2. Hips joints at the surface of the water.</p>

BP 1 Back Layout Position


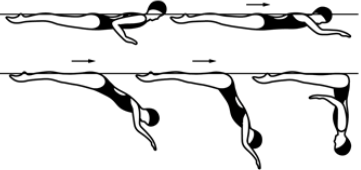
Body Position Description	Diagrams	Major Desired Actions
<p>1. Body extended with face, chest, thighs and feet at the surface of the water.</p>		<p>1. Gives the impression that the body is stretched horizontally to its maximum. Front of the trunk will also be at the surface of the water.</p>
<p>2. Head (ears specifically), hips and ankles in horizontal alignment.</p>		<p>2. Judgement is made by checking visual points of the horizontal alignment: ears, shoulder joints, hip joints and ankles. This imaginary line should also pass through the middle of the side of the trunk.</p>

Figure – 359 FRONT ARIANA (cont.)

DIFFICULTY – 2.2

BM 3 To Assume a Front Pike Position/A Front Pike Position is assumed

Basic Movement Description	NVT	Diagrams	Major Desired Actions
<p>1. From a Front Layout Position with the face in the water the trunk moves downward to assume a Front Pike Position. The buttocks, legs and feet travel along the surface of the water until the hips occupy the position of the head at the beginning of this action.</p>	<p>6.0</p>		<p>1.1 See BP 2 Front Layout Position and BP 10 Front Pike Position. Uniform motion in downward movement of the trunk. The trunk remains straight throughout the movement. Hips and head lock into position simultaneously.</p> <p>1.2 Unless otherwise specified, <i>To Assume a Front Pike Position</i> starts from a Front Layout Position.</p>

BM 16 Ariana Rotation






Basic Movement Description	NVT	Diagrams	Major Desired Actions
<p>1. From a Split Position maintaining the relative position of the legs to the surface of the water the hips rotate 180°.</p>	<p>17.0</p>		<p>1.1 See BP 16a Surface Split Position.</p> <p>1.2 The trunk turns 180° around its longitudinal axis, while the legs rotate horizontally with no lateral movement at the surface of the water.</p> <p>1.3 Height and extension of the Split Position is maintained throughout.</p> <p>1.4 Uniform motion throughout.</p> <p>1.5 Lower back arched with hips, shoulders and head on a vertical line.</p> <p>1.6 Hip joints and shoulder joints on a horizontal line with both of these alignments 'square' and parallel to each other.</p>

Figure – 359 FRONT ARIANA (cont.)

DIFFICULTY – 2.2

BM 6 Walkout

Basic Movement Description	NVT	Diagrams	Major Desired Actions
<p>1. These movements start in a Split Position unless otherwise specified in the figure description. The hips remain stationary as one leg is lifted in an arc over the surface of the water to meet the opposite leg.</p> <p>a) Walkout Front</p> <p>2. The front leg is lifted in a 180° arc over the surface of the water to meet the opposite leg in a Surface Arch Position and with continuous movement an <i>Arch to Back Layout Finish Action</i> is executed.</p>			<p>1. See BP 16a Surface Split Position.</p>
	23.0		<p>2.1 Hip height remains constant and at the surface of the water. 2.2 Arcing leg moves continuously with uniform motion. 2.3 Both legs maintain full extension. 2.4 The trunk remains stationary until the feet join. 2.5 No pause in BP 13 Surface Arch Position, however an accurate surface arch must be evident before the body begins to rise and straighten. 2.6 Foot first surfacing motion begins when the feet are joined. 2.7 See BP 13 Surface Arch Position and BM 5 <i>Arch to Back Layout Finish Action</i>.</p>
	7.0		
			

BM 5 Arch to Back Layout Finish Action



Basic Movement Description	NVT	Diagrams	Major Desired Actions
<p>1. From a Surface Arch Position the hips, chest and face surface sequentially at the same point with foot first movement to a Back Layout Position until the head occupies the position of the hips at the beginning of this action.</p>	7.0	 	<p>1. See BP 13 Surface Arch Position. Sharp arch in the lower back. The body rises, straightens and moves along the surface of the water with a stationary BP 1 Back Layout Position achieved as the face surfaces. Full extension maintained throughout.</p>

Figure – 360 WALKOVER FRONT

DIFFICULTY – 1.9

From a **Front Layout Position** a *Front Pike Position* is assumed. One leg is lifted in a 180° arc over the surface of the water to a **Split Position**. A *Walkout Front* is executed.




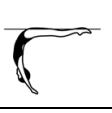

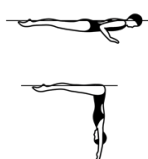
					Total
NVT=	6.0	20.0	23.0	7.0	56
PV =	1.07	3.57	4.11	1.25	10

Figure Description	NVT	Diagrams	Major Desired Actions
--------------------	-----	----------	-----------------------

1. From a **Front Layout Position** a *Front Pike Position* is assumed.

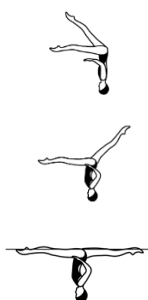
6.0



1. See BP 2 **Front Layout**, BP 10 **Front Pike Position** and BM 3 *To Assume a Front Pike Position*.
Smooth even movement downwards of the trunk.

2. One leg is lifted in a 180° arc over the surface of the water to a **Split Position**.

20.0



2.1 See 16a **Surface Split Position**. Constant height and continuous uniform motion to achieve BP 16a **Surface Split Position**.
2.2 Trunk maintains its vertical alignment, with hips and shoulders 'square'.
2.3 Full extension of the horizontal leg at the surface of the water.

3. A *Walkout Front* is executed

23.0



3. See BM 6a *Walkout Front* and BM 5 *Arch to Back Layout Action*.

7.0



See Figure 359 Front Ariana for **Front Layout Position**, **Front Pike Position**, **Split Position**, **Surface Arch Position**, **Back Layout Position**, *To Assume a Front Pike Position Basic Movement*, *Walkout Basic Movement*, and *Arch to Back Layout Finish Action Basic Movement*.

Figure – 361 PRAWN

DIFFICULTY – 1.5

From a **Front Layout Position** a *Front Pike Position* is assumed. One leg is lifted in a 180° arc over the surface of the water to a **Split Position**. The legs are joined to assume a **Vertical Position** at ankle level. A *Vertical Descent* is executed.






					Total
NVT=	6.0	20.0	5.0	5.0	36
PV =	1.67	5.56	1.39	1.39	10

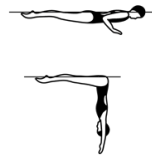
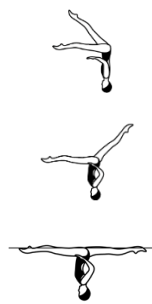
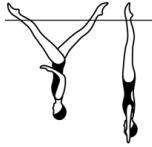
Figure Description	NVT	Diagrams	Major Desired Actions
1. From a Front Layout Position a <i>Front Pike Position</i> is assumed.	6.0		1. See BP 2 Front Layout , BP 10 Front Pike Position and BM 3 <i>To Assume a Front Pike Position</i> . Smooth even movement downwards of the trunk.
2. One leg is lifted in a 180° arc over the surface of the water to a Split Position .	20.0		2.1 See 16a Surface Split Position . Constant height and continuous uniform motion to achieve BP 16a Surface Split Position . 2.2 Trunk maintains its vertical alignment, with hips and shoulders 'square'. 2.3 Full extension of the horizontal leg at the surface of the water.
3. The legs are joined to assume a Vertical Position at ankle level.	5.0		3. From BP 16a Surface Split Position , the legs are joined simultaneously remaining equidistant from the surface of the water throughout the descent to BP 6 Vertical Position – ankle level.

Figure – 361 PRAWN

DIFFICULTY – 1.5

Figure Description	NVT	Diagrams	Major Desired Actions
--------------------	-----	----------	-----------------------

4. A *Vertical Descent* is executed

5.0



4. See BM 10 *Vertical Descent*.

See Figure 359 Front Ariana for **Front Layout Position, Front Pike Position, Split Position** and *To Assume a Front Pike Position Basic Movement*.

BP 6 Vertical Position – ankle level

Body Position Description	Diagrams	Major Desired Actions
---------------------------	----------	-----------------------

1. Body extended perpendicular to the surface of the water; legs together, head downward.



1. Full extension of the body.

2. Head (ears specifically), hips and ankles in line.

2. Judgement is made by checking visual points of the vertical alignment: ears, shoulder joints, hip joints and ankles.

BM 10 Vertical Descent – from ankle level

Basic Movement Description	NVT	Diagrams	Major Desired Actions
----------------------------	-----	----------	-----------------------

1. Maintaining a **Vertical Position** the body descends along its longitudinal axis until the toes are submerged.

5.0



1. See BP 6 **Vertical Position**. The tempo of the descent is uniform and at the same speed as the rest of the figure.

Figure – 362 SURFACE PRAWN

DIFFICULTY – 1.3

From a **Front Layout Position** a *Front Pike Position* is assumed. One foot is moved in a horizontal arc of 180° at the surface of the water to a **Split Position**. The legs are joined to assume a **Vertical Position** at ankle level. A *Vertical Descent* is executed.






					Total
NVT=	6.0	9.0	5.0	5.0	25
PV =	2.40	3.60	2.00	2.00	10

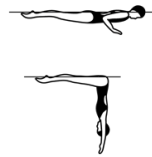
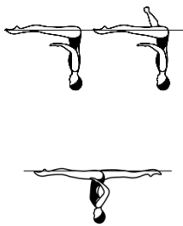
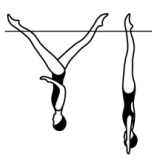

Figure Description	NVT	Diagrams	Major Desired Actions
1. From a Front Layout Position a <i>Front Pike Position</i> is assumed.	6.0		1. See BP 2 Front Layout , BP 10 Front Pike Position and BM 3 <i>To Assume a Front Pike Position</i> . Smooth even movement downwards of the trunk.
2. One foot is moved in a horizontal arc of 180° at the surface of the water to a Split Position .	9.0		2.1 Continuous uniform motion to achieve BP 16a Surface Split Position . 2.2 The trunk maintains its vertical alignment with the hips and shoulders 'square'. 2.3 The foot of the horizontal leg remains at the surface of the water. 2.4 The foot of the arcing leg is at the surface of the water, not above or below. 2.5 Full extension of both legs at the surface of the water.
3. The legs are joined to assume a Vertical Position at ankle level.	5.0		3. From BP 16a Surface Split Position , the legs are joined simultaneously remaining equidistant from the surface of the water throughout the descent to BP 6 Vertical Position – ankle level.

Figure – 362 SURFACE PRAWN (cont.)
DIFFICULTY – 1.3

Figure Description	NVT	Diagrams	Major Desired Actions
4. A <i>Vertical Descent</i> is executed	5.0		4. See BM 10 <i>Vertical Descent</i> .

See Figure 359 Front Ariana for **Front Layout Position, Front Pike Position, Split Position** and *To Assume a Front Pike Position Basic Movement*.

See Figure 361 Prawn for **Vertical Position – ankle level** and *Vertical Descent from ankle level Basic Movement*.

Figure – 363 WATER DROP

DIFFICULTY – 1.8

From a **Front Layout Position** a *Front Pike Position* is assumed. The legs are lifted simultaneously to a **Bent Knee Vertical Position**. A *Half Twist* is executed. A *180° Spin* is executed in the same direction as the bent leg is extended to a **Vertical Position** and completed as the ankles reach the surface of the water. A *Vertical Descent* is executed.







						Total
NVT=	6.0	15.0	15.0	13.0	0	49
PV =	1.22	3.06	3.06	2.65	0	10

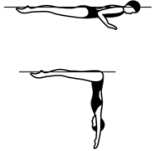




Figure Description	NVT	Diagrams	Major Desired Actions
1. From a Front Layout Position a <i>Front Pike Position</i> is assumed.	6.0		1. See BP 2 Front Layout , BP 10 Front Pike Position and BM 3 <i>To Assume a Front Pike Position</i> . Smooth even movement downwards of the trunk.
2. The legs are lifted simultaneously to a Bent Knee Vertical Position .	15.0		2. See BP 14c Bent Knee Vertical Position . The trunk remains on the vertical line. The Bent Knee Vertical Position is achieved as the vertical is reached.
3. A <i>Half Twist</i> is executed.	15.0		3. See BM 12a <i>Half Twist</i> . The <i>Half Twist</i> is performed in a Bent Knee Vertical Position .

Figure – 363 WATER DROP (cont.)

DIFFICULTY – 1.8

Figure Description	NVT	Diagrams	Major Desired Actions
4. A <i>180° Spin</i> is executed in the same direction as the bent leg is extended to a Vertical Position and completed as the ankles reach the surface of the water.	13.0		<p>4.1 See BM 13d <i>180° Spin</i> and BP 6 Vertical Position. Body alignment remains constant during the extension of the bent leg.</p> <p>4.2 The joining of the bent leg to vertical, the completion of the <i>180° Spin</i> and the establishment of the BP 6 Vertical Position at ankle level are achieved simultaneously. The bent leg is extended upward and the <i>180° Spin</i> is executed at the same rate of space and time as that of the drop spaces of the vertical leg.</p> <p>4.3 Simultaneous descent and extension of the bent leg as feet join.</p>
5. A <i>Vertical Descent</i> is executed.	0		5. See BM 10 <i>Vertical Descent</i> .

Note: Refer to Section BM 12 Twists and Twist Allowances and Section BM 13 Spins and Spins Allowances.

BP 2 Front Layout Position



Body Position Description	Diagrams	Major Desired Actions
1. Body extended with head, upper back, buttocks and heels at the surface of the water.		1. Gives the impression that the body is stretched horizontally to its maximum. Judgement made by checking visual points of the horizontal alignment: ears, shoulder joints, hip joints and heels.


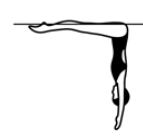
Figure – 363 WATER DROP (cont.)

DIFFICULTY – 1.8

BP 2 Front Layout Position (cont.)

Body Position Description	Diagrams	Major Desired Actions
2. Unless otherwise specified, face may be in or out of the water.		2. Once the head position is established as in or out of the water the position is maintained. When the face is out of the water the ears will not be on the horizontal axis and the back may be slightly lower and arched. Hip joints, calves and heels remain at the surface of the water.

BP 10 Front Pike Position

Body Position Description	Diagrams	Major Desired Actions
1. Body bent at hips to form a 90° angle.		1. Exact 90° angle.
2. Legs extended and together.		2. Full extension of legs, with ankles aligned with hip joints.
3. Trunk extended with the back straight and head in line.		3. Back flat, with vertical alignment of ears, shoulder joints and hip joints once the position is established.

BP 14 Bent Knee Position

Body Position Description	Diagrams	Major Desired Actions
One leg bent with the toe of the bent leg in contact with the inside of the extended leg at the knee or higher.		The relationship of the toe of the bent leg to the extended leg may vary depending on the figure but should remain constant once established, and not extend in front of or behind the extended leg.

c) Bent Knee Vertical Position

1. Body extended in **Vertical Position** with the thigh of the bent leg parallel to the surface of the water.




1. In BP 6 **Vertical Position** the alignment of the extended leg, trunk and head remains constant.

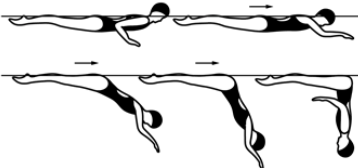
Figure – 363 WATER DROP (cont.)

DIFFICULTY – 1.8

BP 6 Vertical Position - ankle level

Body Position Description	Diagrams	Major Desired Actions
<p>1. Body extended perpendicular to the surface of the water; legs together, head downward.</p> <p>2. Head (ears specifically), hips and ankles in line.</p>		<p>1. Full extension of the body.</p> <p>2. Judgement is made by checking visual points of the vertical alignment: ears, shoulder joints, hip joints and ankles.</p>

BM 3 To Assume a Front Pike Position/A Front Pike Position is assumed

Basic Movement Description	NVT	Diagrams	Major Desired Actions
<p>1. From a Front Layout Position with the face in the water the trunk moves downward to assume a Front Pike Position. The buttocks, legs and feet travel along the surface of the water until the hips occupy the position of the head at the beginning of this action.</p>	6.0		<p>1.1 See BP 2 Front Layout Position and BP 10 Front Pike Position. Uniform motion in downward movement of the trunk. The trunk remains straight throughout the movement. Hips and head lock into position simultaneously.</p> <p>1.2 Unless otherwise specified, <i>To Assume a Front Pike Position</i> starts from a Front Layout Position.</p>

BM 12 Twist – Half Twist in Bent Knee Vertical Position

Basic Movement Description	NVT	Diagrams	Major Desired Actions
<p>1. A <i>Twist</i> is a rotation at a sustained height.</p> <p>2. The body remains on its longitudinal axis throughout the rotation.</p>			<p>1. Height remains constant throughout the rotation. Stability and alignment of the position is evident before, during and upon completion of the <i>Twist</i>. The amount of height is judged by the relationship of the hip joints to the surface of the water with maximum height desirable.</p> <p>2. The longitudinal axis runs through the centre of the body and is perpendicular to the surface of the water. On the spot rotation around this axis.</p>

Figure – 363 WATER DROP (cont.)

DIFFICULTY – 1.8

BM 12 Twist – Half Twist in Bent Knee Vertical Position (cont.)

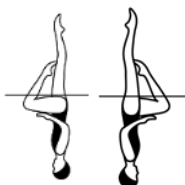
Basic Movement Description	NVT	Diagrams	Major Desired Actions
----------------------------	-----	----------	-----------------------

Half Twist in Bent Knee Vertical Position

4.

a) **Half Twist:** a *Twist* of 180°.

15.0



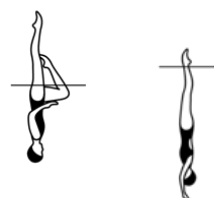
See Twist Allowance.

BM 13d 180° Spin – adapted for Bent Knee Vertical joining to Vertical at ankle level

Basic Movement Description	NVT	Diagrams	Major Desired Actions
----------------------------	-----	----------	-----------------------

1. A *180° Spin* is a descending rotation executed as the bent leg is extended to a **Vertical Position** and is completed as the ankles reach the surface of the water.

13.0



1. See BP 14c **Bent Knee Vertical Position**.

2. The body remains on its longitudinal axis throughout the rotation.

2. The longitudinal axis runs through the centre of the body and is perpendicular to the surface of the water.

3. The *Spin* is executed in uniform motion and is completed with a *Vertical Descent* which is executed at the same tempo as the *Spin*.

3. Uniform motion to be at the same tempo as the root figure.
See BM 10 *Vertical Descent*.

4. A *descending Spin* must start at the height of the vertical and be completed as the ankle(s) reach(es) the surface of the water.

4.1 Stability and vertical alignment before, during and at completion of the designated rotation.
4.2 Simultaneous rotation and descent of the body with even drop spaces to complete the spin as the ankles reach the surface of the water.
See Spin Allowance

Figure – 363 WATER DROP (cont.)
DIFFICULTY – 1.8
BM 10 Vertical Descent – from ankle level

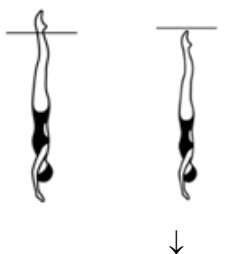
Basic Movement Description	NVT	Diagrams	Major Desired Actions
<p>1. Maintaining a Vertical Position the body descends along its longitudinal axis until the toes are submerged.</p>	<p>0</p>		<p>1. See BP 6 Vertical Position. The tempo of the descent is uniform and at the same speed as the rest of the figure.</p>

Figure – 364 WHIRLWIND

DIFFICULTY – 2.7

From a **Front Layout Position** a *Front Pike Position* is assumed. One leg is lifted to a **Fishtail Position**. All remaining movements are performed rapidly. Maintaining the **Fishtail Position**, with the horizontal leg leading toward the vertical leg, two rotations (720°) are executed. Continuing in the same direction, a *Helicopter Rotation Continuous Spin 720°* is executed.






					Total
NVT=	6.0	14.5	50.0	29.5	100
PV =	0.60	1.45	5.00	2.95	10

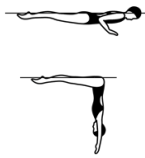

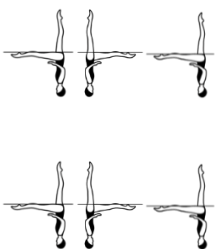
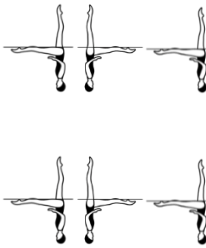
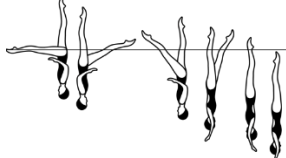
Figure Description	NVT	Diagrams	Major Desired Actions
1. From a Front Layout Position a <i>Front Pike Position</i> is assumed.	6.0		1. See BP 2 Front Layout , BP 10 Front Pike Position and BM 3 <i>To Assume a Front Pike Position</i> . Smooth even movement downwards of the trunk.
2. One leg is lifted to a Fishtail Position .	14.5		2.1 See BP 8 Fishtail Position . Height and vertical alignment of the trunk is maintained. 2.2 The Fishtail Position is held only long enough to define the position and to demonstrate completion of the transition.
3. Maintaining the Fishtail Position , with the horizontal leg leading toward the vertical leg, two rotations (720°) are executed.	50.0		3.1 This action is performed rapidly. 3.2 In BP 8 Fishtail Position the vertical leg remains stationary and height remains constant during the rapid rotations. 3.3 The foot of the horizontal leg is at the surface of the water and not above or below. 3.4 Alignment of the trunk is maintained as both legs move rapidly as a 'locked' unit. 3.5 The horizontal and vertical leg each maintain alignment.

Figure – 364 WHIRLWIND (cont.)

DIFFICULTY – 2.7

Figure Description	NVT	Diagrams	Major Desired Actions
<p>3. (cont.) Maintaining the Fishtail Position, with the horizontal leg leading toward the vertical leg, two rotations (720°) are executed.</p>	50.0		3.6 Hips are the pivot point during the rapid rotations.
<p>4. Continuing in the same direction a <i>Helicopter Rotation Continuous Spin 720°</i> is executed.</p>	29.5		4. This action is performed rapidly. See BM 17 <i>Helicopter Rotation Continuous Spin 720°</i> .

See Figure 363 Water Drop for **Front Layout Position**, **Front Pike Position** and *To Assume A Front Pike Basic Movement*.

Note: Refer to Section BM 12 Twists and Twist Allowances and BM 13 Spins and Spin Allowances.

BP 8 Fishtail Position

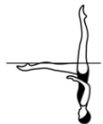

Body Position Description	Diagrams	Major Desired Actions
<p>1. Body extended in Vertical Position with one leg extended forward. The foot of the forward leg is at the surface of the water regardless of the height of the hips.</p>		<p>1. See BP 6 Vertical Position for body alignment. The foot of the forward leg must be at the surface of the water. Hip joints must be on a horizontal line.</p>

Figure – 364 WHIRLWIND (cont.)

DIFFICULTY – 2.7

BP 6 Vertical Position - ankle level

Body Position Description	Diagrams	Major Desired Actions
<p>1. Body extended perpendicular to the surface of the water; legs together, head downward.</p> <p>2. Head (ears specifically), hips and ankles in line.</p>		<p>1. Full extension of the body.</p> <p>2. Judgement is made by checking visual points of the vertical alignment: ears, shoulder joints, hip joints and ankles.</p>

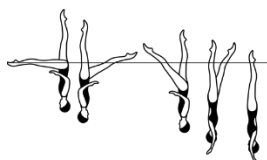
BM 17 Helicopter Rotation

Basic Movement Description	NVT	Diagrams	Major Desired Actions
<p>1. From a Fishtail Position the horizontal leg is lifted while closing into the vertical leg to assume a Vertical Position during a descending rotation and is completed as the ankles reach the surface of the water.</p>			<p>1.1 This action is performed rapidly.</p> <p>1.2 See BP 8 Fishtail Position. The legs are joined while descending and rotating to assume a BP 6 Vertical Position at ankle level.</p> <p>1.3 The vertical leg maintains the vertical line throughout the rotation.</p> <p>1.4 Longitudinal axis is maintained throughout the rotation.</p> <p>1.5 The tempo of the rotation and descent is uniform and rapid.</p> <p>1.6 Refer to Section BM 13 <i>Spins</i> and <i>Spin Allowances</i>.</p>

c) Continuous Spin 720°

c) **Continuous Spin 720°**: a *descending Spin* with a rapid rotation of: 720° (2), completed as the ankles reach the surface of the water and continues through submergence.

29.5



Refer to BM 17 *Helicopter Rotation* Step 1 Major Desired Actions.

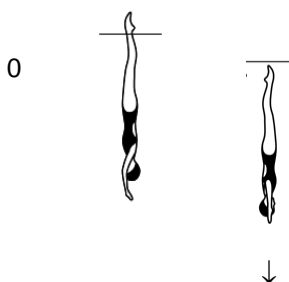
Figure – 364 WHIRLWIND (cont.)

DIFFICULTY – 2.7

BM 17 Helicopter Rotation (cont.)

Basic Movement Description	NVT	Diagrams	Major Desired Actions
----------------------------	-----	----------	-----------------------

2. Maintaining a **Vertical Position** the body continues its rotation and descends along its longitudinal axis until the toes are submerged.



2. See BP 6 **Vertical Position** and BM 10 *Vertical Descent*. The tempo from the ankles until submergence is rapid.



WORLD
AQUATICS

Artistic Swimming Figures Manual

2022 – 2025

Part 2

Category IV

CATEGORY IV		
401	Swordfish	2.1
402	Swordasub	2.3
403	Swordtail	2.3
405	Swordalina	2.5
406	Swordfish Straight Leg	2.3
407	Swordfish Straight Leg Ariana Rotation	2.6
410	Hightower	3.3
413	Alba	2.7
420	Walkover Back	2.1
421	Walkover Back Closing 360°	2.4
423	Ariana	2.5
435	Nova	2.2
435c	Nova Twirl	2.7
435d	Nova Spinning 180°	2.3
435e	Nova Spinning 360°	2.3
435f	Nova Continuous Spin (720°)	2.6
435g	Nova Twist Spin	2.8
436	Cyclone	2.4
436c	Cyclone Twirl	2.8
436d	Cyclone Spinning 180°	2.4
436e	Cyclone Spinning 360°	2.4
436f	Cyclone Continuous Spin (720°)	2.7
437	Cyclone Open 180°	2.6
438	Oceanea	2.2
439	Oceanita	1.8

CATEGORY IV		
440	Ipanema	3.0
440d	Ipanema Spinning 180°	3.1
441	Saturn	2.5
441e	Saturn Spinning 360°	2.6

Figure – 401 SWORDFISH

DIFFICULTY – 2.1

From a **Front Layout Position** a **Bent Knee Front Layout Position** is assumed. The back arches more as the extended leg is lifted in a 180° arc over the surface of the water to assume a **Bent Knee Surface Arch Position**. The bent leg is straightened to assume a **Surface Arch Position**. With continuous motion an *Arch to Back Layout Finish Action* is executed.






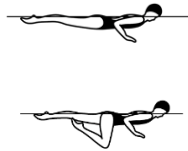
					Total
NVT=	4.0	47.0	11.5	7.0	69.5
PV =	0.58	6.76	1.65	1.01	10

Figure Description	NVT	Diagrams	Major Desired Actions
--------------------	-----	----------	-----------------------

1. From a **Front Layout Position** a **Bent Knee Front Layout Position** is assumed.

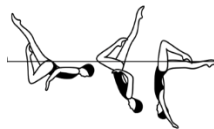
4.0



1. See BP 2 **Front Layout** and BP 14a **Bent Knee Front Layout Position**. There can be no change of head position once the leg starts to bend to assume the **Bent Knee Front Layout Position**.

2. The back arches more as the extended leg is lifted in a 180° arc over the surface of the water to assume a **Bent Knee Surface Arch Position**.

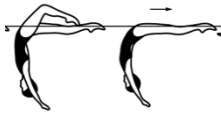

47.0





2.1 See BP 14d **Bent Knee Surface Arch Position**. The lifting of the extended leg and arching of the back occur simultaneously. The foot of the extended leg comes off the surface of the water as the head goes under the surface of the water.
 2.2 There is continuous motion as the extended leg is lifted in a 180° arc over the surface of the water to a **Bent Knee Surface Arch Position** with the toe of the bent leg remaining in contact with the inside of the extended leg.
 2.3 The hips maintain constant height and are the pivot point for the body rotation.

Figure – 401 SWORDFISH (cont.)

DIFFICULTY – 2.1

Figure Description	NVT	Diagrams	Major Desired Actions
3. The bent leg is straightened to assume a Surface Arch Position .	11.5		3. See BP 13 Surface Arch Position . The trunk maintains the same position until the feet join. The Surface Arch Position should be shown, but not held prior to the start of the surfacing action. Hip joints remain on a horizontal line, full extension of the legs with thighs and feet at the surface of the water.
4. With continuous motion an <i>Arch to Back Layout Finish Action</i> is executed.	7.0		4. See BM 5 <i>Arch to Back Layout Finish Action</i> .



BP 2 Front Layout Position

Body Position Description	Diagrams	Major Desired Actions
1. Body extended with head, upper back, buttocks and heels at the surface of the water.		1. Gives the impression that the body is stretched horizontally to its maximum. Judgement made by checking visual points of the horizontal alignment: ears, shoulder joints, hip joints and heels.
2. Unless otherwise specified, face may be in or out of the water.		2. Once the head position is established as in or out of the water the position is maintained. When the face is out of the water the ears will not be on the horizontal axis and the back may be slightly lower and arched. Hip joints, calves and heels remain at the surface of the water.

BP 14 Bent Knee Position

Body Position Description	Diagrams	Major Desired Actions
One leg bent with the toe of the bent leg in contact with the inside of the extended leg at the knee or higher.		The relationship of the toe of the bent leg to the extended leg may vary depending on the figure but should remain constant once established, and not extend in front of or behind the extended leg.

Figure – 401 SWORDFISH (cont.)
DIFFICULTY – 2.1
BP 14 Bent Knee Position (cont.)

Body Position Description	Diagrams	Major Desired Actions
<p>a) Bent Knee Front Layout Position</p> <p>1. Body extended in Front Layout Position with the thigh of the bent leg perpendicular to the surface of the water.</p> <p>2. Unless otherwise specified face may be in or out of the water.</p>		<p>1. In BP 2 Front Layout Position the alignment of the extended leg, trunk and head remains constant.</p> <p>2. Once established as in or out of the water, the head position is maintained. When the face is out of the water, the ears will not be on the horizontal axis, and the back may be slightly lower and arched. Hip joints and the calf and heel of the extended leg remain at the surface of the water.</p>
<p>d) Bent Knee Surface Arch Position</p> <p>1. Lower back arched with hips, shoulders and head on a vertical line.</p> <p>2. The thigh of the bent leg is perpendicular to the surface of the water.</p>		<p>1.1 In BP 13 Surface Arch Position shoulder joints and hip joints on a horizontal line with both of these alignments 'square' and parallel to one another. Head (ears specifically) in line with shoulders.</p> <p>1.2 Hips at the surface of the water.</p> <p>2. 90° angle between the thigh of the bent leg and the surface of the water. An air pocket will be evident between the back of the thigh and calf of the bent leg and the surface of the water.</p>

BP 13 Surface Arch Position



Body Position Description	Diagrams	Major Desired Actions
<p>1. Lower back arched with hips, shoulders and head on a vertical line.</p> <p>2. Legs together and at the surface of the water.</p>		<p>1. Hip joints and shoulder joints on a horizontal line with both of these alignments 'square' and parallel to one another. Head (ears specifically) in line with shoulders.</p> <p>2. Hips joints at the surface of the water.</p>

Figure – 401 SWORDFISH (cont.)

DIFFICULTY – 2.1

BP 1 Back Layout Position

Body Position Description	Diagrams	Major Desired Actions
<p>1. Body extended with face, chest, thighs and feet at the surface of the water.</p>		<p>1. Gives the impression that the body is stretched horizontally to its maximum. Front of the trunk will also be at the surface of the water.</p>
<p>2. Head (ears specifically), hips and ankles in horizontal alignment.</p>		<p>2. Judgement is made by checking visual points of the horizontal alignment: ears, shoulder joints, hip joints and ankles. This imaginary line should also pass through the middle of the side of the trunk.</p>

BM 5 Arch to Back Layout Finish Action


Basic Movement Description	NVT	Diagrams	Major Desired Actions
<p>1. From a Surface Arch Position the hips, chest and face surface sequentially at the same point with foot first movement to a Back Layout Position until the head occupies the position of the hips at the beginning of this action.</p>	7.0		<p>1. See BP 13 Surface Arch Position. Sharp arch in the lower back. The body rises, straightens and moves along the surface of the water with a stationary BP 1 Back Layout Position achieved as the face surfaces. Full extension maintained throughout.</p>

Figure – 402 SWORDASUB

DIFFICULTY – 2.3

From a **Front Layout Position** a **Bent Knee Front Layout Position** is assumed. The back arches more as the extended leg is lifted in a 180° arc over the surface of the water. As the extended leg passes vertical the bent leg straightens with the foot following a vertical line through the hips to assume a **Surface Ballet Leg Position**. The face and the foot of the extended leg reach the surface of the water simultaneously. The *Ballet Leg is lowered*.







						Total
NVT=	4.0	31.0	24.5	11.0	10.5	81
PV =	0.49	3.83	3.02	1.36	1.30	10

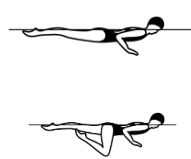




Figure Description	NVT	Diagrams	Major Desired Actions
1. From a Front Layout Position a Bent Knee Front Layout Position is assumed.	4.0		1. See BP 2 Front Layout and BP 14a Bent Knee Front Layout Position . There can be no change of the head position once the leg starts to bend to assume the Bent Knee Front Layout Position .
2. The back arches more as the extended leg is lifted in a 180° arc over the surface of the water.	31.0		2.1 The lifting of the extended leg and arching of the back occur simultaneously. The foot of the extended leg comes off the surface of the water as the head goes under the surface of the water. 2.2 There is continuous motion as the extended leg is lifted in a 180° arc over the surface of the water. 2.3 The hips maintain constant height and are the pivot point for the body rotation.

Figure – 402 SWORDASUB (cont.)

DIFFICULTY – 2.3

Figure Description	NVT	Diagrams	Major Desired Actions
<p>3. As the extended leg passes vertical the bent leg straightens with the foot following a vertical line through the hips to assume a Surface Ballet Leg Position. The face and the foot of the extended leg reach the surface of the water simultaneously.</p> <p>It is important to note that the bent leg in the Bent Knee Front Layout Position must become the vertical leg in the Surface Ballet Leg Position.</p> <p>The diagram shows the Bent Knee Front Layout Position to the Surface Ballet Leg Position movement performed with the right (R) leg shaded black however either leg can be used to perform the action.</p>	24.5		<p>3.1 See BP 3a Surface Ballet Leg Position. With continuous motion there is simultaneous extension of the bent leg vertically, the lowering of the extended leg horizontally and the raising of the body to BP 3a Surface Ballet Leg Position.</p> <p>3.2 The hips maintain constant height and are the pivot point for the body rotation.</p>
4. The <i>Ballet Leg is lowered</i> .	11.0		4. See BM 2 <i>To Lower A Ballet Leg</i> .
	10.5		

See Figure 401 Swordfish for **Front Layout Position** and **Bent Knee Front Layout Position**.

BP 3 Ballet Leg Position



Body Position Description	Diagrams	Major Desired Actions
<p>a) Surface</p> <p>1. Body in Back Layout Position.</p>		<p>1. See BP 1 Back Layout Position. Ears, shoulder joints, hip joints and ankle of extended leg in line at maximum horizontal alignment.</p>
<p>2. One leg extended perpendicular to the surface of the water.</p>		<p>2. 90° angle between the extended leg and the surface of the water and between the extended leg and the trunk with maximum horizontal alignment maintained throughout.</p>


Figure – 402 SWORDASUB (cont.)

DIFFICULTY – 2.3

BP 14 Bent Knee Position

Body Position Description	Diagrams	Major Desired Actions
<p>One leg bent with the toe of the bent leg in contact with the inside of the extended leg at the knee or higher.</p> <p>b) Bent Knee Back Layout Position</p> <p>1. Body extended in Back Layout Position.</p>		<p>The relationship of the toe of the bent leg to the extended leg may vary depending on the figure but should remain constant once established, and not extend in front of or behind the extended leg.</p> <p>1. In BP 1 Back Layout Position ears, shoulder joints, hip joints and ankle of extended leg in line at maximum horizontal alignment.</p> <p>2. 90° angle between the thigh and the surface of the water, and 90° angle maintained between the thigh and the trunk. At maximum height an air pocket will be evident between the back of the thigh and calf of the bent leg and the surface of the water.</p>
<p>2. The thigh of the bent leg is perpendicular to the surface of the water.</p>		

BP 1 Back Layout Position

Body Position Description	Diagrams	Major Desired Actions
<p>1. Body extended with face, chest, thighs and feet at the surface of the water.</p> <p>2. Head (ears specifically), hips and ankles in horizontal alignment.</p>		<p>1. Gives the impression that the body is stretched horizontally to its maximum. Front of the trunk will also be at the surface of the water.</p> <p>2. Judgement is made by checking visual points of the horizontal alignment: ears, shoulder joints, hip joints and ankles. This imaginary line should also pass through the middle of the side of the trunk.</p>

BM 2 To Lower a Ballet Leg/A Ballet Leg is lowered


Basic Movement Description	NVT	Diagrams	Major Desired Actions
<p>1. From a Ballet Leg Position the ballet leg is bent without movement of the thigh to a Bent Knee Back Layout Position.</p>			<p>1. See BP 3a Surface Ballet Leg Position and BP 14b Bent Knee Back Layout Position. Height remains constant throughout the movement.</p>

Figure – 402 SWORDASUB (cont.)

DIFFICULTY – 2.3

BM 2 To Lower a Ballet Leg/A Ballet Leg is lowered (cont.)



Basic Movement Description	NVT	Diagrams	Major Desired Actions
2. The toe moves along the inside of the extended leg until a Back Layout Position is assumed.	11.0		2.1 Full extension in BP 1 Back Layout Position to be achieved as the feet are joined. 2.2 The head and trunk remain stationary throughout.
	10.5		

Figure – 403 SWORDTAIL

DIFFICULTY – 2.3

From a **Front Layout Position** a **Bent Knee Front Layout Position** is assumed. The back arches more as the extended leg is lifted in an arc of 180° over the surface of the water. As the extended leg passes vertical the bent leg straightens with the foot following a vertical line to assume a **Knight Position**. The vertical leg is lowered to a **Surface Arch Position**. An *Arch to Back Layout Finish Action* is executed.







						Total
NVT=	4.0	31.0	20.0	18.5	7.0	80.5
PV =	0.50	3.85	2.48	2.30	0.87	10



Figure Description	NVT	Diagrams	Major Desired Actions
1. From a Front Layout Position a Bent Knee Front Layout Position is assumed.	4.0	 	1. See BP 2 Front Layout and BP 14a Bent Knee Front Layout Position . There can be no change of head position once the knee starts to bend to assume the Bent Knee Front Layout Position .

Figure – 403 SWORDTAIL (cont.)
DIFFICULTY – 2.3


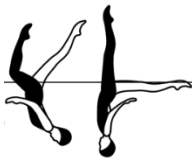


Figure Description	NVT	Diagrams	Major Desired Actions
<p>2. The back arches more as the extended leg is lifted in a 180° arc over the surface of the water.</p>	31.0		<p>2.1 The lifting of the extended leg and arching of the back occur simultaneously. The foot of the extended leg comes off the surface of the water as the head goes under the surface of the water.</p> <p>2.2 There is continuous motion as the extended leg is lifted in a 180° arc over the surface of the water.</p> <p>2.3 The hips maintain constant height and are the pivot point for the body rotation.</p>
<p>3. As the extended leg passes vertical the bent leg straightens with the foot following a vertical line to assume a Knight Position.</p> <p>It is important to note that the bent leg in the Bent Knee Front Layout Position must become the vertical leg in the Knight Position.</p> <p>The diagram shows the Bent Knee Front Layout Position to the Knight Position movement performed with the right (R) leg shaded black however either leg can be used to perform the action.</p>	20.0		<p>3.1 See BP 17 Knight Position. With continuous motion there is simultaneous extension of the bent leg vertically, the lowering of the extended leg horizontally and the body assuming a Knight Position.</p> <p>3.2 The hips maintain constant height and are the pivot point for the body rotation.</p>

Figure – 403 SWORDTAIL (cont.)

DIFFICULTY – 2.3

Figure Description	NVT	Diagrams	Major Desired Actions
4. The vertical leg is lowered to a Surface Arch Position .	18.5		<p>4.1 See BP 13 Surface Arch Position. Hip and shoulder joints remain on a horizontal line.</p> <p>4.2 Hip height remains constant and at the surface of the water.</p> <p>4.3 Both legs maintain full extension.</p> <p>4.4 The trunk maintains the same position and remains stationary until the feet join.</p> <p>4.5 No pause in BP 13 Surface Arch Position however an accurate surface arch must be evident before BM 5 <i>Arch to Back Layout Finish Action</i> occurs.</p>
5. An <i>Arch to Back Layout Finish Action</i> is executed.	7.0		5. See BM 5 <i>Arch to Back Layout Finish Action</i> .

See Figure 401 Swordfish for **Front Layout Position, Bent Knee Front Layout Position, Surface Arch Position, Back Layout Position** and *Arch to Back Layout Position Basic Movement*.

BP 17 Knight Position

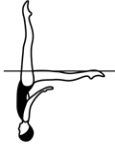
Body Position Description	Diagrams	Major Desired Actions
1. Lower back arched, with hips, shoulders and head on a vertical line.		1. Arch is in the lower part of the spine only.
2. One leg vertical.		2. Vertical alignment through ears, shoulder joints, hip joints and ankle of the vertical leg.
3. Other leg extended backward with the leg at the surface of the water and as close to horizontal as possible.		3. Hip joints and shoulder joints on a horizontal line with both of these alignments 'square' and parallel to each other. The top of the horizontal extended leg faces upward.

Figure – 405 SWORDALINA

DIFFICULTY – 2.5

From a **Front Layout Position** a **Bent Knee Front Layout Position** is assumed. The back arches more as the extended leg is lifted in an arc over the surface of the water until the foot is directly over the head. The hips rotate 180° as the trunk rises with minimal lateral movement to a **Submerged Flamingo Position**. As the body rises the bent leg is straightened to assume a **Surface Ballet Leg Position**. The *Ballet Leg is lowered*.








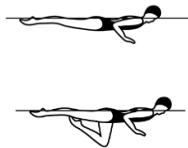
							Total
NVT=	4.0	31.0	21.0	10.5	11.0	10.5	88
PV =	0.45	3.52	2.39	1.19	1.25	1.19	10

Figure Description	NVT	Diagrams	Major Desired Actions
--------------------	-----	----------	-----------------------

1. From a **Front Layout Position**, a **Bent Knee Front Layout Position** is assumed.

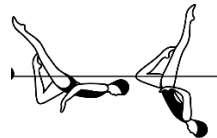
4.0



1. See BP 2 **Front Layout** and BP 14a **Bent Knee Front Layout Position**. There can be no change of head position once the knee starts to bend to assume the **Bent Knee Front Layout Position**.

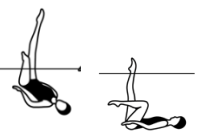



2. The back arches more as the extended leg is lifted in an arc over the surface of the water until the foot is directly over the head.

31.0



2.1 See BP 14a **Bent Knee Front Layout Position**. The lifting of the extended leg and arching of the back occur simultaneously. The foot of the extended leg comes off the surface of the water as the head goes under the surface of the water.
 2.2 The hips maintain constant height and are the pivot point for the body rotation.
 2.3 Alignment of the head and foot evident prior to initiation of the rotation.

Figure – 405 SWORDALINA (cont.)
DIFFICULTY – 2.5

Figure Description	NVT	Diagrams	Major Desired Actions
3. The hips rotate 180° as the trunk rises with minimal lateral movement to a Submerged Flamingo Position .	21.0		3. Hips are stationary during the rotation and rise of the trunk to BP 4b Submerged Flamingo Position .
4. As the body rises the bent leg is straightened to assume a Surface Ballet Leg Position .	10.5		4. BP 3a Surface Ballet Leg is achieved as the face surfaces and the bent leg reaches full extension at the surface of the water.
5. The <i>Ballet Leg</i> is lowered.	11.0		5. See BM 2 To Lower A <i>Ballet Leg</i> .
	10.5		

BP 2 Front Layout Position




Body Position Description	Diagrams	Major Desired Actions
1. Body extended with head, upper back, buttocks and heels at the surface of the water.		1. Gives the impression that the body is stretched horizontally to its maximum. Judgement made by checking visual points of the horizontal alignment: ears, shoulder joints, hip joints and heels.
2. Unless otherwise specified, face may be in or out of the water.		2. Once the head position is established as in or out of the water the position is maintained. When the face is out of the water the ears will not be on the horizontal axis and the back may be slightly lower and arched. Hip joints, calves and heels remain at the surface of the water.

Figure – 405 SWORDALINA (cont.)
DIFFICULTY – 2.5
BP 14 Bent Knee Position

Body Position Description	Diagrams	Major Desired Actions
<p>One leg bent with the toe of the bent leg in contact with the inside of the extended leg at the knee or higher.</p>		<p>The relationship of the toe of the bent leg to the extended leg may vary depending on the figure but should remain constant once established, and not extend in front of or behind the extended leg.</p>
<p>a) Bent Knee Front Layout Position</p>		
<p>1. Body extended in Front Layout Position with the thigh of the bent leg perpendicular to the surface of the water.</p>		<p>1. In BP 2 Front Layout Position the alignment of the extended leg, trunk and head remains constant.</p>
<p>2. Unless otherwise specified face may be in or out of the water.</p>		<p>2. Once established as in or out of the water, the head position is maintained. When the face is out of the water, the ears will not be on the horizontal axis, and the back may be slightly lower and arched. Hip joints and the calf and heel of the extended leg remain at the surface of the water.</p>

BP 4 Flamingo Position



Body Position Description	Diagrams	Major Desired Actions
<p>b) Submerged</p>		
<p>1. Trunk, head, shin and foot of the bent leg parallel to the surface of the water.</p>		<p>1. Ears, shoulder joints and hip joints aligned.</p>
<p>2. 90° angle between the trunk and extended leg.</p>		<p>2. The vertical leg is extended perpendicular to the bent leg midway between the knee and the ankle of the horizontal leg.</p>
<p>3. Water level between knee and ankle of the extended leg.</p>		


Figure – 405 SWORDALINA (cont.)

DIFFICULTY – 2.5

BP 3 Ballet Leg Position

Body Position Description	Diagrams	Major Desired Actions
<p>a) Surface</p> <p>1. Body in Back Layout Position.</p> <p>2. One leg extended perpendicular to the surface of the water.</p>		<p>1. See BP 1 Back Layout Position. Ears, shoulder joints, hip joints and ankle of extended leg in line at maximum horizontal alignment.</p> <p>2. 90° angle between the extended leg and the surface of the water and between the extended leg and the trunk with maximum horizontal alignment maintained throughout.</p>

BP 14 Bent Knee Position

Body Position Description	Diagrams	Major Desired Actions
<p>One leg bent with the toe of the bent leg in contact with the inside of the extended leg at the knee or higher.</p>		<p>The relationship of the toe of the bent leg to the extended leg may vary depending on the figure but should remain constant once established, and not extend in front of or behind the extended leg.</p>
<p>b) Bent Knee Back Layout Position</p> <p>1. Body extended in Back Layout Position.</p> <p>2. The thigh of the bent leg is perpendicular to the surface of the water.</p>		<p>1. In BP 1 Back Layout Position ears, shoulder joints, hip joints and ankle of extended leg in line at maximum horizontal alignment.</p> <p>2. 90° angle between the thigh and the surface of the water, and 90° angle maintained between the thigh and the trunk. At maximum height an air pocket will be evident between the back of the thigh and calf of the bent leg and the surface of the water.</p>

BP 1 Back Layout Position


Body Position Description	Diagrams	Major Desired Actions
<p>1. Body extended with face, chest, thighs and feet at the surface of the water.</p>		<p>1. Gives the impression that the body is stretched horizontally to its maximum. Front of the trunk will also be at the surface of the water.</p>

Figure – 405 SWORDALINA (cont.)

DIFFICULTY – 2.5

BP 1 Back Layout Position (cont.)

Body Position Description	Diagrams	Major Desired Actions
2. Head (ears specifically), hips and ankles in horizontal alignment.		2. Judgement is made by checking visual points of the horizontal alignment: ears, shoulder joints, hip joints and ankles. This imaginary line should also pass through the middle of the side of the trunk.

BM 2 To Lower a Ballet Leg/A Ballet Leg is lowered




Basic Movement Description	NVT	Diagrams	Major Desired Actions
1. From a Ballet Leg Position the ballet leg is bent without movement of the thigh to a Bent Knee Back Layout Position .			1. See BP 3a Surface Ballet Leg Position and BP 14b Bent Knee Back Layout Position . Height remains constant throughout the movement.
2. The toe moves along the inside of the extended leg until a Back Layout Position is assumed.	11.0		2.1 Full extension in BP 1 Back Layout Position to be achieved as the feet are joined.
	10.5		2.2 The head and trunk remain stationary throughout

Figure – 406 SWORDFISH STRAIGHT LEG

DIFFICULTY – 2.3

From a **Front Layout Position** the back arches more as one leg is lifted in a 180° arc over the surface of the water to a **Split Position**. A *Walkout Front* is executed.





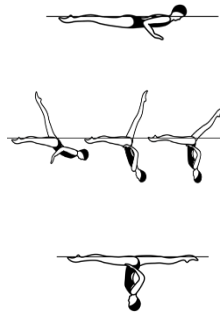
				Total
NVT=	48.0	23.0	7.0	78
PV =	6.15	2.95	0.90	10

Figure Description	NVT	Diagrams	Major Desired Actions
--------------------	-----	----------	-----------------------

1. From a **Front Layout Position** the back arches more as one leg is lifted in a 180° arc over the surface of the water to a **Split Position**.

48.0



1.1 See BP 2 **Front Layout Position** and BP 16a **Surface Split Position**.

The lifting of the leg and arching of the back occur simultaneously. The foot of the lifted leg comes off the surface of the water as the head goes under the surface of the water.

1.2 There is uniform continuous motion as the leg is lifted in a 180° arc over the surface of the water to a surface **Split Position**.

1.3 The hips remain stationary, maintain constant height and are the pivot point for the body rotation.

1.4 The head is in vertical alignment with the hips when the foot of the arcing leg passes the vertical position.

1.5 The non-arching leg remains fully extended and at the surface of the water.

2. A *Walkout Front* is executed.

23.0





2. See BM 6a *Walkout Front* and BM 5 *Arch to Back Layout Finish Action*

7.0



Figure – 406 SWORDFISH STRAIGHT LEG (cont.)
DIFFICULTY – 2.3
BP 2 Front Layout Position

Body Position Description	Diagrams	Major Desired Actions
1. Body extended with head, upper back, buttocks and heels at the surface of the water.		1. Gives the impression that the body is stretched horizontally to its maximum. Judgement made by checking visual points of the horizontal alignment: ears, shoulder joints, hip joints and heels.
2. Unless otherwise specified, face may be in or out of the water.		2. Once the head position is established as in or out of the water the position is maintained. When the face is out of the water the ears will not be on the horizontal axis and the back may be slightly lower and arched. Hip joints, calves and heels remain at the surface of the water.

BP 16 Split Position





Body Position Description	Diagrams	Major Desired Actions
1. Legs evenly split forward and back. 2. The legs are parallel to the surface of the water. 3. Lower back arched, with hips, shoulders and head on a vertical line. 4. 180° angle between the extended legs (flat split), with inside of each leg aligned on opposite sides of a horizontal line, regardless of the height of the hips.		1. Full extension of the legs at or above the surface of the water. 4. Flat split. Hip joints and shoulder joints on a horizontal line, with both of these alignments 'square' and parallel to each other.
a) Surface Split Position 1. Legs are dry at the surface of the water.		1. Full extension of the legs. Crotch and legs dry at the surface of the water.

Figure – 406 SWORDFISH STRAIGHT LEG (cont.)
DIFFICULTY – 2.3
BP 13 Surface Arch Position

Body Position Description	Diagrams	Major Desired Actions
1. Lower back arched with hips, shoulders and head on a vertical line.		1. Hip joints and shoulder joints on a horizontal line with both of these alignments 'square' and parallel to one another. Head (ears specifically) in line with shoulders.
2. Legs together and at the surface of the water.		2. Hips joints at the surface of the water.

BP 1 Back Layout Position

Body Position Description	Diagrams	Major Desired Actions
1. Body extended with face, chest, thighs and feet at the surface of the water.		1. Gives the impression that the body is stretched horizontally to its maximum. Front of the trunk will also be at the surface of the water.
2. Head (ears specifically), hips and ankles in horizontal alignment.		2. Judgement is made by checking visual points of the horizontal alignment: ears, shoulder joints, hip joints and ankles. This imaginary line should also pass through the middle of the side of the trunk.

BM 6 Walkouts


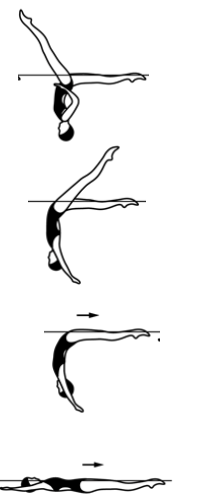
Basic Movement Description	NVT	Diagrams	Major Desired Actions
1. These movements start in a Split Position unless otherwise specified in the figure description. The hips remain stationary as one leg is lifted in an arc over the surface of the water to meet the opposite leg.			1. See BP 16a Surface Split Position .

Figure – 406 SWORDFISH STRAIGHT LEG (cont.)

DIFFICULTY – 2.3

BM 6 Walkouts (cont.)

Basic Movement Description	NVT	Diagrams	Major Desired Actions
<p>a) Walkout Front</p> <p>2. The front leg is lifted in a 180° arc over the surface of the water to meet the opposite leg in a Surface Arch Position and with continuous movement an <i>Arch to Back Layout Finish Action</i> is executed.</p>	<p>23.0</p> <p>7.0</p>		<p>2.1 Hip height remains constant and at the surface of the water.</p> <p>2.2 Arcing leg moves continuously with uniform motion.</p> <p>2.3 Both legs maintain full extension.</p> <p>2.4 The trunk remains stationary until the feet join.</p> <p>2.5 No pause in BP 13 Surface Arch Position, however an accurate surface arch must be evident before the body begins to rise and straighten.</p> <p>2.6 Foot first surfacing motion begins when the feet are joined.</p> <p>2.7 See BP 13 Surface Arch Position and BM 5 <i>Arch to Back Layout Finish Action</i>.</p>

BM 5 Arch to Back Layout Finish Action

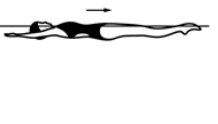
Basic Movement Description	NVT	Diagrams	Major Desired Actions
<p>1. From a Surface Arch Position the hips, chest and face surface sequentially at the same point with foot first movement to a Back Layout Position until the head occupies the position of the hips at the beginning of this action.</p>	<p>7.0</p>		<p>1. See BP 13 Surface Arch Position. Sharp arch in the lower back. The body rises, straightens and moves along the surface of the water with a stationary BP 1 Back Layout Position achieved as the face surfaces. Full extension maintained throughout.</p>

Figure – 407 SWORDFISH STRAIGHT LEG ARIANA ROTATION DIFFICULTY – 2.6

From a **Front Layout Position** the back arches more as one leg is lifted in a 180° arc over the surface of the water to a **Split Position**. Maintaining the relative position of the legs to the surface of the water an *Ariana Rotation* is performed. A *Walkout Front* is executed.

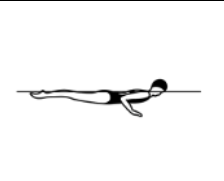
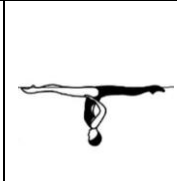
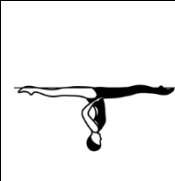
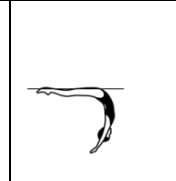
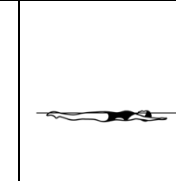
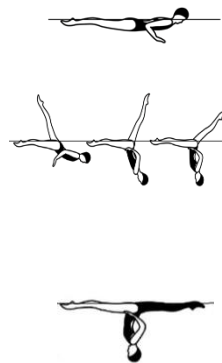
					Total
NVT=	48.0	17.0	23.0	7.0	95
PV =	5.05	1.79	2.42	0.74	10

Figure Description	NVT	Diagrams	Major Desired Actions
--------------------	-----	----------	-----------------------

1. From a **Front Layout Position** the back arches more as one leg is lifted in a 180° arc over the surface of the water to a **Split Position**.

48.0



1.1 See BP 2 **Front Layout Position** and BP 16a **Surface Split Position**.

The lifting of the leg and arching of the back occur simultaneously. The foot of the lifted leg comes off the surface of the water as the head goes under the surface of the water.





1.2 There is uniform continuous motion as the leg is lifted in a 180° arc over the surface of the water to a **Surface Split Position**.

1.3 The hips remain stationary, maintain constant height and are the pivot point for the body rotation.

1.4 The head is in vertical alignment with the hips when the foot of the arcing leg passes the vertical position.

1.5 The non-arching leg remains fully extended and at the surface of the water.

Figure – 407 SWORDFISH STRAIGHT LEG ARIANA ROTATION DIFFICULTY – 2.6 (cont.)

Figure Description	NVT	Diagrams	Major Desired Actions
2. Maintaining the relative position of the legs to the surface of the water an <i>Ariana Rotation</i> is performed.	17.0	 	2. See BM 16 <i>Ariana Rotation</i> .
3. A <i>Walkout Front</i> is executed.	23.0		3. See BM 6a <i>Walkout Front</i> and BM 5 <i>Arch to Back Layout Finish Action</i> .
	7.0		

See Figure 406 Swordfish Straight Leg for **Front Layout Position, Split Position, Surface Arch Position, Back Layout Position, Walkout Front Basic Movement** and *Arch to Back Layout Position Basic Movement*.

BM 16 Ariana Rotation




Basic Movement Description	NVT	Diagrams	Major Desired Actions
1. From a Split Position maintaining the relative position of the legs to the surface of the water the hips rotate 180°.	17.0	  	1.1 See BP 16a Surface Split Position . 1.2 The trunk turns 180° around its longitudinal axis, while the legs rotate horizontally with no lateral movement at the surface of the water. 1.3 Height and extension of the Split Position is maintained throughout. 1.4 Uniform motion throughout. 1.5 Lower back arched with hips, shoulders and head on a vertical line. 1.6 Hip joints and shoulder joints on a horizontal line with both of these alignments 'square' and parallel to each other.

Figure – 410 HIGHTOWER

DIFFICULTY – 3.3

From a **Front Layout Position** the back arches more as one leg is lifted over the surface of the water until the foot of the lifting leg is directly over the head. The body is straightened to a **Fishtail Position** assuming a vertical midway between the former vertical line through the hips and the former vertical line through the foot and the head. The horizontal leg is lifted to a **Vertical Position**. A *Vertical Descent* is executed until the toes are submerged. Maintaining the vertical line of the legs the body is piked as the trunk rises to assume a submerged **Back Pike Position**. A *Thrust* is executed to a **Vertical Position**. A *Vertical Descent* is executed at the same tempo as the *Thrust*.




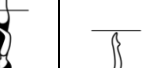


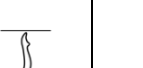
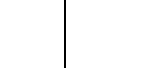
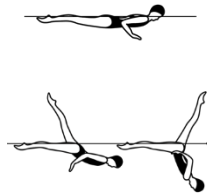
								Total
NVT=	30.5	14.0	20.5	14.0	12.0	31.0	13.0	135
PV =	2.26	1.04	1.52	1.04	0.89	2.30	0.96	10

Figure Description	NVT	Diagrams	Major Desired Actions
--------------------	-----	----------	-----------------------

1. From a **Front Layout Position** the back arches more as one leg is lifted over the surface of the water until the foot of the lifting leg is directly over the head.

30.5



1.1 See BP 2 **Front Layout Position**. The lifting of the leg and arching of the back occur simultaneously. The foot of the lifted leg comes off the surface of the water as the head goes under the surface of the water
 1.2 The hips remain stationary, maintain constant height and are the pivot point for the body rotation.
 1.3 The alignment of the foot and head is evident prior to initiation of the body straightening to a **Fishtail Position**.

Figure – 410 HIGHTOWER (cont.)
DIFFICULTY – 3.3





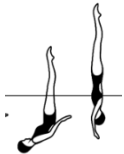



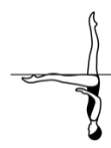
Figure Description	NVT	Diagrams	Major Desired Actions
2. The body is straightened to a Fishtail Position assuming a vertical midway between the former vertical line through the hips and the former vertical line through the foot and the head.	14.0		2. See BP 8 Fishtail Position . Height maintained.
3. The horizontal leg is lifted to a Vertical Position .	20.5		3.1 See BP 6 Vertical Position . Height is constant as the legs join, with the trunk and the vertical leg maintaining vertical alignment. 3.2 The Vertical Position is held only long enough to define the position and to demonstrate completion of the transition.
4. A <i>Vertical Descent</i> is executed until the toes are submerged.	14.0		4. See BM 10 <i>Vertical Descent</i> .
5. Maintaining the vertical line of the legs the body is piked as the trunk rises to assume a submerged Back Pike Position .	12.0		5. See BP 11 Back Pike Position . Once the toes are submerged the height on the legs remains constant until a submerged Back Pike Position is assumed with the legs remaining on the same vertical line.
6. A <i>Thrust</i> is executed to a Vertical Position .	31.0		6. See BM 9 <i>Thrust</i> .
7. A <i>Vertical Descent</i> is executed at the same tempo as the <i>Thrust</i> .	13.0		7. See BM 10 <i>Vertical Descent</i> .

Figure – 410 HIGHTOWER (cont.)
DIFFICULTY – 3.3
BP 2 Front Layout Position

Body Position Description	Diagrams	Major Desired Actions
1. Body extended with head, upper back, buttocks and heels at the surface of the water.		1. Gives the impression that the body is stretched horizontally to its maximum. Judgement made by checking visual points of the horizontal alignment: ears, shoulder joints, hip joints and heels.
2. Unless otherwise specified, face may be in or out of the water.		2. Once the head position is established as in or out of the water the position is maintained. When the face is out of the water the ears will not be on the horizontal axis and the back may be slightly lower and arched. Hip joints, calves and heels remain at the surface of the water.

BP 8 Fishtail Position

Body Position Description	Diagrams	Major Desired Actions
1. Body extended in Vertical Position with one leg extended forward. The foot of the forward leg is at the surface of the water regardless of the height of the hips.		1. See BP 6 Vertical Position for body alignment. The foot of the forward leg must be at the surface of the water. Hip joints must be on a horizontal line.

BP 6 Vertical Position



Body Position Description	Diagrams	Major Desired Actions
1. Body extended perpendicular to the surface of the water; legs together, head downward.		1. Full extension of the body.
2. Head (ears specifically), hips and ankles in line.		2. Judgement is made by checking visual points of the vertical alignment: ears, shoulder joints, hip joints and ankles.

Figure – 410 HIGHTOWER (cont.)

DIFFICULTY – 3.3

BP 11 Back Pike Position

Body Position Description	Diagrams	Major Desired Actions
1. Body bent at hips to form an acute angle of 45° or less.		1. Legs close to chest while maintaining the straight line alignment of the extended spine and head.
2. Legs extended and together.		2. Full extension of the legs, ankles and feet.
3. Trunk extended with the back straight and head in line.		3. Back flat, with ears, shoulder joints, middle of side of torso, and hip joints aligned. Once the pike position is established the degree of the angle remains constant.

BM 9 Thrust

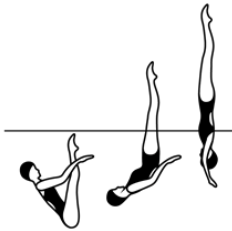
Basic Movement Description	NVT	Diagrams	Major Desired Actions
1. From a Submerged Back Pike Position with the legs perpendicular to the surface of the water a vertical upward movement of the legs and hips is rapidly executed as the body unrolls to assume a Vertical Position .	31.0		<p>1.1 See BP 11 Back Pike Position. The toes are just below the surface of the water. Once established, the degree of the angle of the pike position between the legs and the body must not change prior to initiation of the <i>Thrust</i>.</p> <p>1.2 See BP 6 Vertical Position. The body unrolls rapidly under the legs to assume BP 6 Vertical Position along the same perpendicular line to the surface of the water established by the legs in the BP 11 Back Pike Position.</p> <p>1.3 Obvious increase in speed from the initiation of body unrolling through the vertical upward movement.</p>
2. Maximum height desirable.			2. Maximum height and BP 6 Vertical Position achieved simultaneously.

Figure – 410 HIGHTOWER (cont.)
DIFFICULTY – 3.3
Thrust Allowance

Deviation allowances for the *Thrust* action are unique and allow for the legs to be up to an additional 15 degrees off the vertical line.

Deductions are as follows:

	Angle Deviation	Deduction Amount
Small Deviation	0 – 30 degrees	.2
Medium Deviation	31 – 45 degrees	.5
Large Deviation	46 degrees or more	1.0

BM 10 Vertical Descent – from Thrust

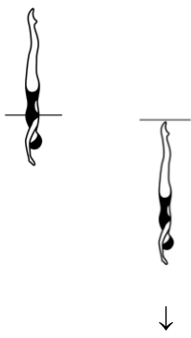
Basic Movement Description	NVT	Diagrams	Major Desired Actions
<p>1. Maintaining a Vertical Position the body descends along its longitudinal axis until the toes are submerged.</p>	13.0		<p>1. See BP 6 Vertical Position. The <i>Vertical Descent</i> is executed at the same tempo as the <i>Thrust</i>.</p>

Figure – 413 ALBA

DIFFICULTY – 2.7

From a **Front Layout Position** the back arches more as one leg is lifted over the surface of the water until the foot of the lifting leg is directly over the head. The body is straightened to a **Fishtail Position** assuming a vertical midway between the former vertical line through the hips and the former vertical line through the foot and the head. A *Catalina Reverse Rotation* is executed as the horizontal leg is lifted with minimum lateral movement to assume a **Surface Ballet Leg Double Position**. Without movement of the thighs the shins are lowered to assume a **Tub Position**. The legs are straightened to assume a **Back Layout Position**.


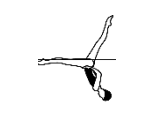

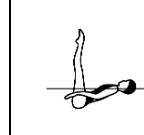
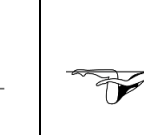
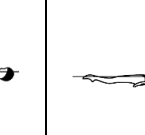
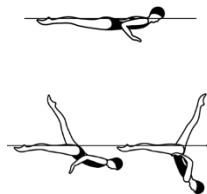
						Total
NVT=	30.5	14.0	31.5	19.0	3.0	98
PV =	3.11	1.43	3.21	1.94	0.31	10

Figure Description	NVT	Diagrams	Major Desired Actions
--------------------	-----	----------	-----------------------

1. From a **Front Layout Position** the back arches more as one leg is lifted over the surface of the water until the foot of the lifting leg is directly over the head.

30.5



1.1 See BP 2 **Front Layout Position**.
The lifting of the leg and arching of the back occur simultaneously. The foot of the lifted leg comes off the surface of the water as the head goes under the surface of the water
1.2 The hips remain stationary, maintain constant height and are the pivot point for the body rotation.
1.3 The alignment of the foot and head is evident prior to initiation of the body straightening to a **Fishtail Position**.

2. The body is straightened to a **Fishtail Position** assuming a vertical midway between the former vertical line through the hips and the former vertical line through the foot and the head.

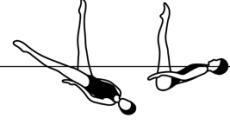


14.0



2.1 See BP 8 **Fishtail Position**. Height maintained.
2.2 The **Fishtail Position** is held only long enough to define the position and to demonstrate completion of the transition.

Figure – 413 ALBA (cont.)

DIFFICULTY – 2.7

Figure Description	NVT	Diagrams	Major Desired Actions
3. A <i>Catalina Reverse Rotation</i> is executed as the horizontal leg is lifted with minimal lateral movement to assume a Surface Ballet Leg Double Position .	31.5		3.1 See BM 8 <i>Catalina Reverse</i> . Simultaneous body rotation and leg lift, with horizontal leg taking most direct route to BP 5a Surface Ballet Leg Double Position , with position achieved as the face surfaces. 3.2 Hip height remains constant.
4. Without movement of the thighs the shins are lowered to assume a Tub Position .	19.0		4. See BP 5a Surface Ballet Leg Double Position and BP 15 Tub Position . The water level and timing remain constant throughout the lowering of the legs from Surface Ballet Leg Double Position to Tub Position .
5. The legs are straightened to assume a Back Layout Position .	3.0		5. Full extension and maximum horizontal alignment in BP 1 Back Layout to be achieved simultaneously.

See Figure 410 Hightower for **Front. Layout Position and Fishtail Position**.

BP 5 Ballet Leg Double Position

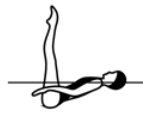

Body Position Description	Diagrams	Major Desired Actions
a) Surface 1. Legs together and extended perpendicular to the surface of the water.		1. Full extension of the legs at a 90° angle to the surface of the water.
2. Head in line with the trunk.		2. Chest close to the surface of the water with the shoulders back. Ears, hip joints and shoulder joints aligned, with the spine straight and extended.
3. Face at the surface of the water.		

Figure – 413 ALBA (cont.)
DIFFICULTY – 2.7
BP 15 Tub Position

Body Position Description	Diagrams	Major Desired Actions
1. Legs bent and together, feet and shins at and parallel to the surface of the water with thighs perpendicular.		1. Knee and hip joints aligned vertically. Legs dry from toes to knees.
2. Head in line with trunk.		2. Chest close to the surface of the water, with the shoulders back. Ears, shoulder joints and hip joints aligned, with the spine extended.
3. Face at the surface of the water.		

BP 1 Back Layout Position


Body Position Description	Diagrams	Major Desired Actions
1. Body extended with face, chest, thighs and feet at the surface of the water.		1. Gives the impression that the body is stretched horizontally to its maximum. Front of the trunk will also be at the surface of the water.
2. Head (ears specifically), hips and ankles in horizontal alignment.		2. Judgement is made by checking visual points of the horizontal alignment: ears, shoulder joints, hip joints and ankles. This imaginary line should also pass through the middle of the side of the trunk.

Figure – 413 ALBA (cont.)
DIFFICULTY – 2.7
BM 8 Catalina Reverse Rotation – adapted for Alba

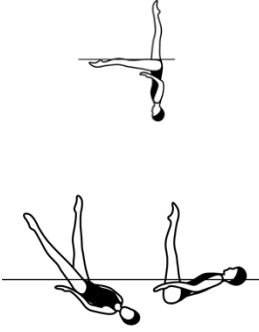
Basic Movement Description	NVT	Diagrams	Major Desired Actions
1. From a Fishtail Position the hips rotate as the trunk rises without lateral movement to assume a Surface Ballet Leg Double Position .	31.5		1.1 See BP 8 Fishtail and BP 5a Surface Ballet Leg Double Positions . 1.2 Height maintained and uniform motion throughout. 1.3 The body rotates and rises simultaneously along the vertical line established by the vertical leg. 1.4 The transition is completed as the face surfaces and the body locks into BP 5a Surface Ballet Leg Double Position . 1.5 At the halfway point, the body is in a tilted 'Y' position, with the trunk and horizontal leg at a 45° angle to the surface and the head, trunk and legs facing forward.

Figure – 420 WALKOVER BACK
DIFFICULTY – 2.1

From a **Back Layout Position** a *Surface Arch Position* is assumed. One leg is lifted in a 180° arc over the surface of the water to a **Split Position**. A *Walkout Back* is executed.






					Total
NVT=	12.0	29.0	19.0	6.0	66
PV =	1.82	4.39	2.88	0.91	10

Figure Description	NVT	Diagrams	Major Desired Actions
--------------------	-----	----------	-----------------------

1. From a **Back Layout Position** a *Surface Arch Position* is assumed.

12.0



1. See BP 1 **Back Layout Position**, BP 14 **Surface Arch Position** and BM 14 *To Assume A Surface Arch Position*.

Continuous movement evident from the **Back Layout Position** to the **Surface Arch Position**.

2. One leg is lifted in a 180° arc over the surface of the water to a **Split Position**.

29.0



2. Both legs remain fully extended. Hips remain stationary and aligned horizontally. Hip height remains constant and at the surface of the water. Continuous uniform motion of arcing leg to BP 16a **Surface Split Position**.

3. A *Walkover Back* is executed.

19.0



6.0




3. See BM 6b *Walkout Back*.


Figure – 420 WALKOVER BACK (cont.)

DIFFICULTY – 2.1


BP 1 Back Layout Position

Body Position Description	Diagrams	Major Desired Actions
1. Body extended with face, chest, thighs and feet at the surface of the water.		1. Gives the impression that the body is stretched horizontally to its maximum. Front of the trunk will also be at the surface of the water.
2. Head (ears specifically), hips and ankles in horizontal alignment.		2. Judgement is made by checking visual points of the horizontal alignment: ears, shoulder joints, hip joints and ankles. This imaginary line should also pass through the middle of the side of the trunk.

BP 13 Surface Arch Position

Body Position Description	Diagrams	Major Desired Actions
1. Lower back arched with hips, shoulders and head on a vertical line.		1. Hip joints and shoulder joints on a horizontal line with both of these alignments 'square' and parallel to one another. Head (ears specifically) in line with shoulders.
2. Legs together and at the surface of the water.		2. Hips joints at the surface of the water.

16 Split Position

Body Position Description	Diagrams	Major Desired Actions
1. Legs evenly split forward and back. 2. The legs are parallel to the surface of the water. 3. Lower back arched, with hips, shoulders and head on a vertical line. 4. 180° angle between the extended legs (flat split), with inside of each leg aligned on opposite sides of a horizontal line, regardless of the height of the hips.		1. Full extension of the legs at or above the surface of the water. 4. Flat split. Hip joints and shoulder joints on a horizontal line, with both of these alignments 'square' and parallel to each other.


a) Surface Split Position

1. Legs are dry at the surface of the water.		1. Full extension of the legs. Crotch and legs dry at the surface of the water.
--	---	---


Figure – 420 WALKOVER BACK (cont.)

DIFFICULTY – 2.1

BP 10 Front Pike Position

Body Position Description	Diagrams	Major Desired Actions
1. Body bent at hips to form a 90° angle.		1. Exact 90° angle.
2. Legs extended and together.		2. Full extension of legs, with ankles aligned with hip joints.
3. Trunk extended with the back straight and head in line.		3. Back flat, with vertical alignment of ears, shoulder joints and hip joints once the position is established.

BP 2 Front Layout Position

Body Position Description	Diagrams	Major Desired Actions
1. Body extended with head, upper back, buttocks and heels at the surface of the water.		1. Gives the impression that the body is stretched horizontally to its maximum. Judgement made by checking visual points of the horizontal alignment: ears, shoulder joints, hip joints and heels.
2. Unless otherwise specified, face may be in or out of the water.		2. Once the head position is established as in or out of the water the position is maintained. When the face is out of the water the ears will not be on the horizontal axis and the back may be slightly lower and arched. Hip joints, calves and heels remain at the surface of the water.

BM 14 To Assume a Surface Arch Position/A Surface Arch Position is Assumed



Basic Movement Description	NVT	Diagrams	Major Desired Actions
1. From a Back Layout Position with the head leading, the head, hips and feet move along the surface of the water.			1. See BP 1 Back Layout Position .


Figure – 420 WALKOVER BACK (cont.)

DIFFICULTY – 2.1

BM 14 To Assume a Surface Arch Position/A Surface Arch Position is Assumed (cont.)

Basic Movement Description	NVT	Diagrams	Major Desired Actions
2. With continuous movement the head leaves the surface of the water as the back is arched more to assume a Surface Arch Position with the hips occupying the position of the head at the beginning of this action.	12.0		2. Continuous uniform movement from the BP 1 Back Layout Position to BP 13 Surface Arch Position . Hip height remains constant. Hip joints on a horizontal line.

BM 6 Walkouts

Basic Movement Description	NVT	Diagrams	Major Desired Actions
1. These movements start in a Split Position unless otherwise specified in the figure description. The hips remain stationary as one leg is lifted in an arc over the surface of the water to meet the opposite leg.			1. See BP 16a Surface Split Position .

b) Walkout Back

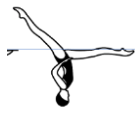




3. The back leg is lifted in a 180° arc over the surface of the water to meet the opposite leg in a Front Pike Position and with continuous movement the body straightens to a Front Layout Position .	19.0	  	3.1 Hip height remains constant and at the surface of the water. 3.2 Arcing leg moves continuously with uniform motion. 3.3 Both legs maintain full extension. 3.4 The trunk remains stationary until the feet join. 3.5 An accurate BP 10 Front Pike Position should be evident before the body begins to straighten and rise. See BP 10 Front Pike and BP 2 Front Layout Position .
4. The head surfaces at the position occupied by the hips at the beginning of this action.	6.0	 	4. The body straightens, rises and moves along the surface simultaneously with a stationary BP 2 Front Layout Position achieved as the head surfaces.

Figure – 421 WALKOVER BACK CLOSING 360°

DIFFICULTY – 2.4

From a **Back Layout Position** a *Surface Arch Position* is assumed. One leg is lifted in a 180° arc over the surface of the water to a **Split Position**. With continuous motion a rotation of 360° is executed as the legs are symmetrically lifted and closed to a **Vertical Position**. A *Vertical Descent* is executed.






					Total
NVT=	12.0	29.0	27.0	14.0	82
PV =	1.46	3.54	3.29	1.71	10

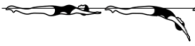



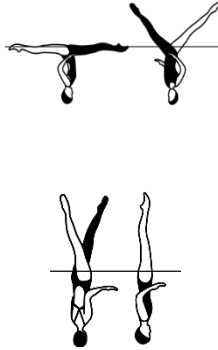

Figure Description	NVT	Diagrams	Major Desired Actions
1. From a Back Layout Position a <i>Surface Arch Position</i> is assumed.	12.0	 	<p>1. See BP 1 Back Layout Position, BP 13 Surface Arch Position and BM 14 <i>To Assume A Surface Arch Position</i>.</p> <p>Continuous movement evident from the Back Layout Position to the Surface Arch Position.</p>
2. One leg is lifted in a 180° arc over the surface of the water to a Split Position .	29.0	 	<p>2.1 Both legs remain fully extended.</p> <p>2.2 Hips remain stationary and aligned horizontally.</p> <p>2.3 Hip height remains constant and at the surface of the water.</p> <p>2.4 Continuous uniform motion of arcing leg to BP 16a Surface Split Position.</p>

Figure – 421 WALKOVER BACK CLOSING 360° (cont.)

DIFFICULTY – 2.4

Figure Description	NVT	Diagrams	Major Desired Actions
3. With continuous motion a rotation of 360° is executed as the legs are symmetrically lifted and closed to a Vertical Position .	27.0		<p>3.1 Both legs are always equidistant from the surface of the water with a 90° angle between them at the halfway point of the 360° rotation.</p> <p>3.2 The rotation and the closing action of the legs to achieve BP 6 Vertical Position occurs simultaneously.</p> <p>3.3 Height remains constant and longitudinal axis maintained throughout the rotation.</p> <p>3.4 The Vertical Position is held only long enough to define the position and to demonstrate completion of the transition prior to the descent.</p>
4. A <i>Vertical Descent</i> is executed.	14.0		4. See BM 10 <i>Vertical Descent</i> .

See Figure 420 Walkover Back for **Back Layout Position, Surface Arch Position, Split Position** and *To Assume A Surface Arch Position Basic Movement*.

BP 6 Vertical Position


Body Position Description	Diagrams	Major Desired Actions
1. Body extended perpendicular to the surface of the water; legs together, head downward.		1. Full extension of the body.
2. Head (ears specifically), hips and ankles in line.		2. Judgement is made by checking visual points of the vertical alignment: ears, shoulder joints, hip joints and ankles.

Figure – 421 WALKOVER BACK CLOSING 360° (cont.)

DIFFICULTY – 2.4

BM 10 Vertical Descent

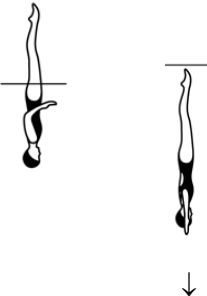
Basic Movement Description	NVT	Diagrams	Major Desired Actions
1. Maintaining a Vertical Position the body descends along its longitudinal axis until the toes are submerged.	14.0		1. See BP 6 Vertical Position . The tempo of the descent is uniform and at the same speed as the rest of the figure.

Figure – 423 ARIANA

DIFFICULTY – 2.5

From a **Back Layout Position** a *Surface Arch Position* is assumed. One leg is lifted in a 180° arc over the surface of the water to a **Split Position**. Maintaining the relative position of the legs to the surface of the water, the hips rotate 180°. A *Walkout Front* is executed.







						Total
NVT=	12.0	29.0	17.0	23.0	7.0	88
PV =	1.36	3.30	1.93	2.61	0.80	10

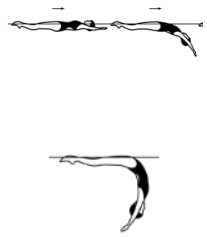






Figure Description	NVT	Diagrams	Major Desired Actions
1. From a Back Layout Position a <i>Surface Arch Position</i> is assumed.	12.0		1. See BP 1 Back Layout Position , BP 13 Surface Arch Position and BM 14 <i>To Assume A Surface Arch Position</i> . Continuous movement evident from the Back Layout Position to the Surface Arch Position .

Figure – 423 ARIANA (cont.)
DIFFICULTY – 2.5


Figure Description	NVT	Diagrams	Major Desired Actions
2. One leg is lifted in a 180° arc over the surface of the water to a Split Position .	29.0	 	2.1 Both legs remain fully extended. 2.2 Hips remain stationary and aligned horizontally. 2.3 Hip height remains constant and at the surface of the water. 2.4 Continuous uniform motion of arcing leg to BP 16a Surface Split Position .
3. Maintaining the relative position of the legs to the surface of the water an <i>Ariana Rotation</i> is performed.	17.0	 	3. See BM 16 <i>Ariana Rotation</i> .
4. A <i>Walkout Front</i> is executed.	23.0		4. See BM 6 <i>Walkout Front</i> and BM 5 <i>Arch up to Back Layout Finish</i> .
	7.0		

See Figure 420 Walkover Back for **Back Layout Position, Surface Arch Position and Split Position** and *To Assume A Surface Arch Basic Movement*.

Figure – 423 ARIANA (cont.)

DIFFICULTY – 2.5

BM 16 Ariana Rotation

Basic Movement Description	NVT	Diagrams	Major Desired Actions
<p>1. From a Split Position maintaining the relative position of the legs to the surface of the water the hips rotate 180°.</p>	17.0		<p>1.1 See BP 16a Surface Split Position. 1.2 The trunk turns 180° around its longitudinal axis, while the legs rotate horizontally with no lateral movement at the surface of the water. 1.3 Height and extension of the Split Position is maintained throughout. 1.4 Uniform motion throughout. 1.5 Lower back arched with hips, shoulders and head on a vertical line. 1.6 Hip joints and shoulder joints on a horizontal line with both of these alignments 'square' and parallel to each other.</p>

BM 6 Walkout


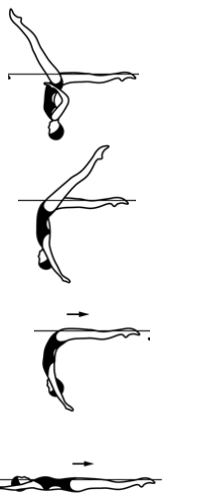
Basic Movement Description	NVT	Diagrams	Major Desired Actions
<p>1. These movements start in a Split Position unless otherwise specified in the figure description. The hips remain stationary as one leg is lifted in an arc over the surface of the water to meet the opposite leg.</p>			<p>1. See BP 16a Surface Split Position.</p>

Figure – 423 ARIANA (cont.)

DIFFICULTY – 2.5

BM 6 Walkout (cont.)

Basic Movement Description	NVT	Diagrams	Major Desired Actions
<p>a) Walkout Front</p> <p>2. The front leg is lifted in a 180° arc over the surface of the water to meet the opposite leg in a Surface Arch Position and with continuous movement an <i>Arch to Back Layout Finish Action</i> is executed.</p>	<p>23.0</p> <p>7.0</p>		<p>2.1 Hip height remains constant and at the surface of the water.</p> <p>2.2 Arcing leg moves continuously with uniform motion.</p> <p>2.3 Both legs maintain full extension.</p> <p>2.4 The trunk remains stationary until the feet join.</p> <p>2.5 No pause in BP 13 Surface Arch Position, however an accurate surface arch must be evident before the body begins to rise and straighten.</p> <p>2.6 Foot first surfacing motion begins when the feet are joined.</p> <p>2.7 See BP 13 Surface Arch Position and BM 5 <i>Arch to Back Layout Finish Action</i>.</p>

BM 5 Arch to Back Layout Finish Action

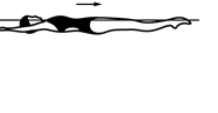
Basic Movement Description	NVT	Diagrams	Major Desired Actions
<p>1. From a Surface Arch Position the hips, chest and face surface sequentially at the same point with foot first movement to a Back Layout Position until the head occupies the position of the hips at the beginning of this action.</p>	<p>7.0</p>		<p>1. See BP 13 Surface Arch Position. Sharp arch in the lower back. The body rises, straightens and moves along the surface of the water with a stationary BP 1 Back Layout Position achieved as the face surfaces. Full extension maintained throughout.</p>

Figure – 435 NOVA

DIFFICULTY – 2.2

From a **Back Layout Position** a *Bent Knee Surface Arch Position* is assumed. The legs are lifted to a **Bent Knee Vertical Position**. A *Full Twist* is executed as the bent leg is extended to meet the vertical leg. A *Vertical Descent* is executed.






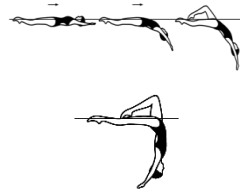
					Total
NVT=	17.5	21.0	22.0	14.0	74.5
PV =	2.35	2.82	2.95	1.88	10

Figure Description	NVT	Diagrams	Major Desired Actions
--------------------	-----	----------	-----------------------

1. From a **Back Layout Position** a *Bent Knee Surface Arch Position* is assumed.

17.5



1. See BP 1 **Back Layout Position**, BP 14d **Bent Knee Surface Arch Position** and BM 15 *To Assume A Bent Knee Surface Arch Position*. Continuous movement evident from the **Back Layout Position** to the **Surface Arch Position**.



2. The legs are lifted to a **Bent Knee Vertical Position**.

21.0




2.1 See BP 14c **Bent Knee Vertical Position**. Body height and position of the toe of the bent leg on the extended leg remains constant while assuming the **Bent Knee Vertical Position**.
 2.2 Trunk alignment maintained between the hips and shoulders. Hips and shoulders aligned horizontally and 'square'.
 2.3 The hips maintain constant height and are the pivot point for the lift to a **Bent Knee Vertical Position**.

Figure – 435 NOVA (cont.)
DIFFICULTY – 2.2

Figure Description	NVT	Diagrams	Major Desired Actions
3. A <i>Full Twist</i> is executed as the bent leg is extended to meet the vertical leg.	22.0		3. See BM 12 <i>Full Twist</i> . Continuous straightening of bent leg completed simultaneously with completion of the <i>Full Twist</i> . Height, stability and vertical alignment maintained throughout the <i>Full Twist</i> .
4. A <i>Vertical Descent</i> is executed.	14.0		4. See BP 6 Vertical Position and BM 10 <i>Vertical Descent</i> .

Note: Refer to Section BM 12 Twists & Twist Allowances.
BP 1 Back Layout Position

Body Position Description	Diagrams	Major Desired Actions
1. Body extended with face, chest, thighs and feet at the surface of the water.		1. Gives the impression that the body is stretched horizontally to its maximum. Front of the trunk will also be at the surface of the water.
2. Head (ears specifically), hips and ankles in horizontal alignment.		2. Judgement is made by checking visual points of the horizontal alignment: ears, shoulder joints, hip joints and ankles. This imaginary line should also pass through the middle of the side of the trunk.


BP 14 Bent Knee Position

Body Position Description	Diagrams	Major Desired Actions
One leg bent with the toe of the bent leg in contact with the inside of the extended leg at the knee or higher.		The relationship of the toe of the bent leg to the extended leg may vary depending on the figure but should remain constant once established, and not extend in front of or behind the extended leg.

Figure – 435 NOVA (cont.)

DIFFICULTY – 2.2

BP 14 Bent Knee Position (cont.)

Body Position Description	Diagrams	Major Desired Actions
<p>d) Bent Knee Surface Arch Position</p> <p>1. Lower back arched with hips, shoulders and head on a vertical line.</p>		<p>1.1 In BP 13 Surface Arch Position shoulder joints and hip joints on a horizontal line with both of these alignments 'square' and parallel to one another. Head (ears specifically) in line with shoulders.</p> <p>1.2 Hips at the surface of the water.</p>
<p>2. The thigh of the bent leg is perpendicular to the surface of the water.</p>		<p>2. 90° angle between the thigh of the bent leg and the surface of the water. An air pocket will be evident between the back of the thigh and calf of the bent leg and the surface of the water.</p>

c) Bent Knee Vertical Position

1. Body extended in **Vertical Position** with the thigh of the bent leg parallel to the surface of the water.



1. In BP 6 **Vertical Position** the alignment of the extended leg, trunk and head remains constant.

BP 6 Vertical Position


Body Position Description	Diagrams	Major Desired Actions
<p>1. Body extended perpendicular to the surface of the water; legs together, head downward.</p>		<p>1. Full extension of the body.</p>
<p>2. Head (ears specifically), hips and ankles in line.</p>		<p>2. Judgement is made by checking visual points of the vertical alignment: ears, shoulder joints, hip joints and ankles.</p>

Figure – 435 NOVA (cont.)

DIFFICULTY – 2.2

BM 15 To Assume a Bent Knee Surface Arch Position/A Bent Knee Surface Arch is Assumed

Basic Movement Description	NVT	Diagrams	Major Desired Actions
1. From a Back Layout Position with the head leading, the head, hips and feet move along the surface of the water.			1. See BP 1 Back Layout Position .
2. With continuous movement the head leaves the surface of the water as the back is arched more to assume a Bent Knee Surface Arch Position with the hips occupying the position of the head at the beginning of this action.	17.5		2.1 Continuous uniform movement from the BP 1 Back Layout Position to BP 14d Bent Knee Surface Arch Position . Hip height remains constant. Hip joints on a horizontal line. 2.2 The toe of the bent leg must remain in contact with the inside of the extended leg while assuming the Bent Knee Surface Arch Position .

BM 10 Vertical Descent

Basic Movement Description	NVT	Diagrams	Major Desired Actions
1. Maintaining a Vertical Position the body descends along its longitudinal axis until the toes are submerged.	14.0		1. See BP 6 Vertical Position . The tempo of the descent is uniform and at the same speed as the rest of the figure.

Nova 435c – 435g – A Nova is executed to the completion of the *Full Twist*. The designated *Twist* or *Spin* is executed.

Note: Refer to Section BM 12 Twists & Twist Allowances and Section BM 13 Spins & Spin Allowances.

Figure – 435c NOVA TWIRL

DIFFICULTY – 2.7

						Total
NVT=	17.5	21.0	22.0	26.0	14.0	100.5
PV =	1.74	2.09	2.19	2.59	1.39	10

Figure – 435 NOVA (cont.)

Nova 435c – 435g – A Nova is executed to the completion of the *Full Twist*. The designated *Twist* or *Spin* is executed.

Note: Refer to Section BM 12 Twists & Twist Allowances and Section BM 13 Spins & Spin Allowances.

Figure – 435d NOVA SPINNING 180°

DIFFICULTY – 2.3

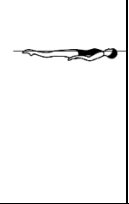
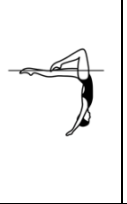
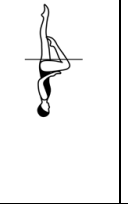
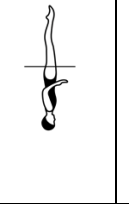
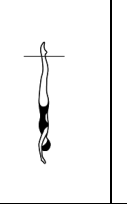
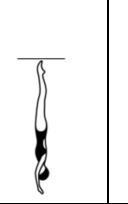
						Total
NVT=	17.5	21.0	22.0	16.0	0	76.5
PV =	2.29	2.75	2.88	2.09	0	10

Figure – 435e NOVA SPINNING 360°

DIFFICULTY – 2.3

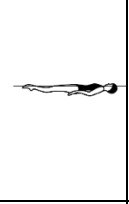
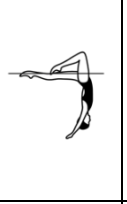
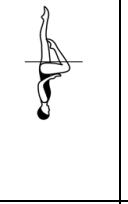
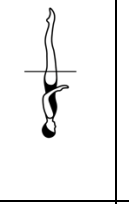
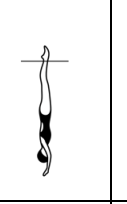
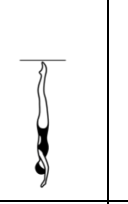
						Total
NVT=	17.5	21.0	22.0	19.0	0	79.5
PV =	2.20	2.64	2.77	2.39	0	10

Figure – 435f NOVA CONTINUOUS SPIN (720°)

DIFFICULTY – 2.6


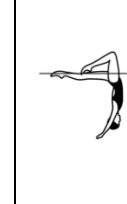
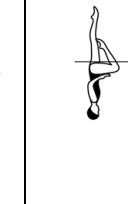
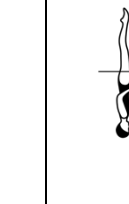
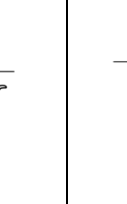
					Total
NVT=	17.5	21.0	22.0	34.0	94.5
PV =	1.85	2.22	2.33	3.60	10

Figure – 435g NOVA TWIST SPIN

DIFFICULTY – 2.8

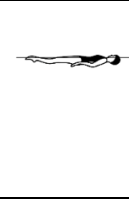
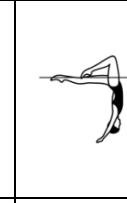

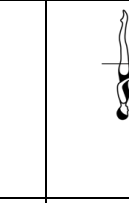
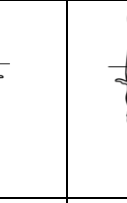

						Total
NVT=	17.5	21.0	22.0	48.0		108.5
PV =	1.61	1.94	2.03	4.42		10

Figure – 436 CYCLONE

DIFFICULTY – 2.4

From a **Back Layout Position** a *Bent Knee Surface Arch Position* is assumed. The legs are simultaneously lifted to a **Vertical Position** as a *Twirl* is executed. A *Half Twist* in the opposite direction is executed. A *Vertical Descent* is executed.






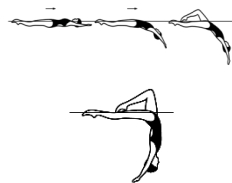
					Total
NVT=	17.5	29.0	21.0	14.0	81.5
PV =	2.15	3.56	2.58	1.72	10

Figure Description	NVT	Diagrams	Major Desired Actions
--------------------	-----	----------	-----------------------

1. From a **Back Layout Position** a *Bent Knee Surface Arch Position* is assumed.

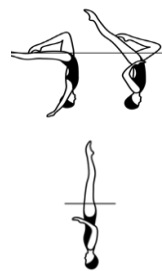
17.5



1. See BP 1 **Back Layout Position**, BP 14d **Bent Knee Surface Arch Position** and BM 15 *To Assume A Bent Knee Surface Arch Position*. Continuous uniform movement from **Back Layout Position** to **Bent Knee Surface Arch Position**.

2. The legs are simultaneously lifted to a **Vertical Position** as a *Twirl* is executed.



29.0




2.1 See BP 6 **Vertical Position** and BM 12c *Twirl*. Trunk alignment maintained between hips and shoulders. Hips and shoulders aligned horizontally and 'square'.
 2.2 Straightening of the bent leg is completed simultaneously with completion of the *Twirl*. A rapid 180° rotation is executed with minimal lateral movement.
 2.3 The hips maintain constant height and are the pivot point for the lift to **Vertical Position**.

Figure – 436 CYCLONE (cont.)

DIFFICULTY – 2.4

Figure Description	NVT	Diagrams	Major Desired Actions
3. A $\frac{1}{2}$ <i>Twist</i> in the opposite direction is executed.	21.0		3. See BM 12a <i>Twists</i> . The acceptable allowance for $\frac{1}{2}$ <i>Twist</i> rotations is up to $\frac{1}{4}$ less than/more than the required rotation.
4. A <i>Vertical Descent</i> is executed.	14.0		4. See BM 10 <i>Vertical Descent</i> . The tempo of the <i>Vertical Descent</i> matches the tempo from the start of the figure to the BP 14d Bent Knee Surface Arch Position .

BP 1 Back Layout Position

Body Position Description	Diagrams	Major Desired Actions
1. Body extended with face, chest, thighs and feet at the surface of the water.		1. Gives the impression that the body is stretched horizontally to its maximum. Front of the trunk will also be at the surface of the water.
2. Head (ears specifically), hips and ankles in horizontal alignment.		2. Judgement is made by checking visual points of the horizontal alignment: ears, shoulder joints, hip joints and ankles. This imaginary line should also pass through the middle of the side of the trunk.


BP 14 Bent Knee Position

Body Position Description	Diagrams	Major Desired Actions
One leg bent with the toe of the bent leg in contact with the inside of the extended leg at the knee or higher.		The relationship of the toe of the bent leg to the extended leg may vary depending on the figure but should remain constant once established, and not extend in front of or behind the extended leg.


Figure – 436 CYCLONE (cont.)

DIFFICULTY – 2.4

BP 14 Bent Knee Position (cont.)

Body Position Description	Diagrams	Major Desired Actions
d) Bent Knee Surface Arch Position		
<p>1. Lower back arched with hips, shoulders and head on a vertical line.</p>		<p>1.1 In BP 13 Surface Arch Position shoulder joints and hip joints on a horizontal line with both of these alignments 'square' and parallel to one another. Head (ears specifically) in line with shoulders.</p> <p>1.2 Hips at the surface of the water.</p>
<p>2. The thigh of the bent leg is perpendicular to the surface of the water.</p>		<p>2. 90° angle between the thigh of the bent leg and the surface of the water. An air pocket will be evident between the back of the thigh and calf of the bent leg and the surface of the water.</p>

BP 6 Vertical Position

Body Position Description	Diagrams	Major Desired Actions
<p>1. Body extended perpendicular to the surface of the water; legs together, head downward.</p>		<p>1. Full extension of the body.</p>
<p>2. Head (ears specifically), hips and ankles in line.</p>		<p>2. Judgement is made by checking visual points of the vertical alignment: ears, shoulder joints, hip joints and ankles.</p>

BM 15 To Assume a Bent Knee Surface Arch Position/A Bent Knee Surface Arch is Assumed

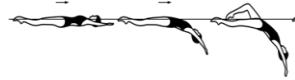

Basic Movement Description	NVT	Diagrams	Major Desired Actions
<p>1. From a Back Layout Position with the head leading, the head, hips and feet move along the surface of the water.</p>			<p>1. See BP 1 Back Layout Position.</p>

Figure – 436 CYCLONE (cont.)

DIFFICULTY – 2.4

BM 15 To Assume a Bent Knee Surface Arch Position/A Bent Knee Surface Arch is Assumed (cont.)

Basic Movement Description	NVT	Diagrams	Major Desired Actions
2. With continuous movement the head leaves the surface of the water as the back is arched more to assume a Bent Knee Surface Arch Position with the hips occupying the position of the head at the beginning of this action.	17.5		2.1 Continuous uniform movement from the BP 1 Back Layout Position to BP 14d Bent Knee Surface Arch Position . Hip height remains constant. Hip joints on a horizontal line. 2.2 The toe of the bent leg must remain in contact with the inside of the extended leg while assuming the Bent Knee Surface Arch Position .

BM 12 Twist


Basic Movement Description	NVT	Diagrams	Major Desired Actions
1. A <i>Twist</i> is a rotation at a sustained height.			1. Height remains constant throughout the rotation. Stability and alignment of the position is evident before, during and upon completion of the <i>Twist</i> . The amount of height is judged by the relationship of the hip joints to the surface of the water with maximum height desirable.
2. The body remains on its longitudinal axis throughout the rotation.			2. The longitudinal axis runs through the centre of the body and is perpendicular to the surface of the water. On the spot rotation around this axis.
c) <i>Twirl</i> : a rapid <i>Twist</i> of 180°. For 436 Cyclone the <i>Twirl</i> starts in a BP 14d Bent Knee Surface Arch Position and is completed in the BP 6 Vertical Position .	29.0		c. The acceptable allowance for ½ <i>Twist</i> rotations is up to ¼ less than/more than the required rotation. Definite increase in speed from the root figure. Stability of body alignment and height remains constant during and after completion of the <i>Twirl</i> .

Figure – 436 CYCLONE (cont.)

DIFFICULTY – 2.4

BM 12 Twist

Basic Movement Description	NVT	Diagrams	Major Desired Actions
4. a) Half Twist: a <i>Twist</i> of 180°.	21.0		4. The acceptable allowance for ½ <i>Twist</i> rotations is up to ¼ less than/more than the required rotation.

BM 10 Vertical Descent

Basic Movement Description	NVT	Diagrams	Major Desired Actions
1. Maintaining a Vertical Position the body descends along its longitudinal axis until the toes are submerged.	14.0		1. See BP 6 Vertical Position . The tempo of the <i>Vertical Descent</i> matches the tempo from the start of the figure in BP 1 Back Layout Position to the BP 14d Bent Knee Surface Arch Position .

Cyclone 436c – 436f – A Cyclone is executed until the completion of the *Half Twist* in the opposite direction. The designated *Twist* or *Spin* is executed in the same direction as the *Half Twist*.

Note: Refer to Section **BM 12 Twists & Twist Allowances** and Section **BM 13 Spins & Spin Allowances**.

Figure – 436c CYCLONE TWIRL

DIFFICULTY – 2.8

							Total
NVT=	17.5	29.0	21.0	26.0	14.0	107.5	
PV =	1.63	2.70	1.95	2.42	1.30	10	

Figure – 436 CYCLONE (cont.)

Cyclone 436c – 436f – A Cyclone is executed until the completion of the *Half Twist* in the opposite direction. The designated *Twist* or *Spin* is executed in the same direction as the *Half Twist*.

Note: Refer to Section BM 12 Twists & Twist Allowances and Section BM 13 Spins & Spin Allowances.

Figure – 436d CYCLONE SPINNING 180°
DIFFICULTY – 2.4







						Total
NVT=	17.5	29.0	21.0	16.0	0	83.5
PV =	2.10	3.47	2.51	1.92	0	10

Figure – 436e CYCLONE SPINNING 360°
DIFFICULTY – 2.4







						Total
NV=	17.5	29.0	21.0	19.0	0	86.5
PV =	2.02	3.35	2.43	2.20	0	10

Figure – 436f CYCLONE CONTINUOUS SPIN (720°)
DIFFICULTY – 2.7






					Total
NVT=	17.5	29.0	21.0	34.0	101.5
PV =	1.72	2.86	2.07	3.35	10

Figure – 437 CYCLONE OPEN 180°

DIFFICULTY – 2.6

From a **Back Layout Position** a *Bent Knee Surface Arch Position* is assumed. The legs are simultaneously lifted to a **Vertical Position** as a *Twirl* is executed. Continuing in the same direction the legs are opened symmetrically to a **Split Position** as a 180° rotation is executed. A *Walkout Front* is executed.







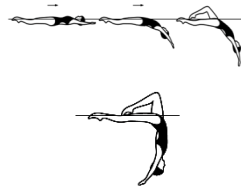
						Total
NVT=	17.5	29.0	20.0	23.0	7.0	96.5
PV =	1.81	3.01	2.07	2.38	0.73	10

Figure Description	NVT	Diagrams	Major Desired Actions
--------------------	-----	----------	-----------------------

1. From a **Back Layout Position** a *Bent Knee Surface Arch Position* is assumed.

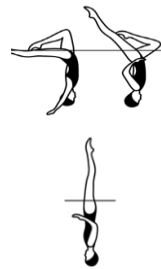
17.5



1. See BP 1 **Back Layout Position**, BP 14d **Bent Knee Surface Arch Position** and BM 15 *To Assume A Bent Knee Surface Arch Position*. Continuous uniform movement from **Back Layout Position** to **Bent Knee Surface Arch Position**.

2. The legs are simultaneously lifted to a **Vertical Position** as a *Twirl* is executed.

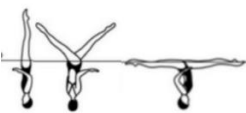


29.0




2.1 See BP 6 **Vertical Position** and BM 12c *Twirl*. Trunk alignment maintained between hips and shoulders. Hips and shoulders aligned horizontally and 'square'.
 2.2 Straightening of the bent leg is completed simultaneously with completion of the *Twirl*. A rapid 180° rotation is executed with minimal lateral movement.
 2.3 The hips maintain constant height and are the pivot point for the lift to **Vertical Position**.

Figure – 437 CYCLONE OPEN 180° (cont.)

DIFFICULTY – 2.6

Figure Description	NVT	Diagrams	Major Desired Actions
3. Continuing in the same direction the legs are opened symmetrically to a Split Position as a 180° rotation is executed.	20.0		3. With continuous motion the body turns 180° on its longitudinal axis as the legs lower simultaneously to BP 16a Surface Split Position . Hip level remains constant and legs are equidistant from the surface of the water at all times.
4. A <i>Walkout Front</i> is executed.	23.0		4. See BM 6a <i>Walkout Front</i> and BM 5 <i>Arch to Back Layout Finish Action</i> .
	7.0		

BP 1 Back Layout Position

Body Position Description	Diagrams	Major Desired Actions
1. Body extended with face, chest, thighs and feet at the surface of the water.		1. Gives the impression that the body is stretched horizontally to its maximum. Front of the trunk will also be at the surface of the water.
2. Head (ears specifically), hips and ankles in horizontal alignment.		2. Judgement is made by checking visual points of the horizontal alignment: ears, shoulder joints, hip joints and ankles. This imaginary line should also pass through the middle of the side of the trunk.


BP 14 Bent Knee Position

Body Position Description	Diagrams	Major Desired Actions
One leg bent with the toe of the bent leg in contact with the inside of the extended leg at the knee or higher.		The relationship of the toe of the bent leg to the extended leg may vary depending on the figure but should remain constant once established, and not extend in front of or behind the extended leg.


Figure – 437 CYCLONE OPEN 180° (cont.)

DIFFICULTY – 2.6

BP 14 Bent Knee Position (cont.)

Body Position Description	Diagrams	Major Desired Actions
<p>d) Bent Knee Surface Arch Position</p> <p>1. Lower back arched with hips, shoulders and head on a vertical line.</p> <p>2. The thigh of the bent leg is perpendicular to the surface of the water.</p>		<p>1.1 In BP 13 Surface Arch Position shoulder joints and hip joints on a horizontal line with both of these alignments 'square' and parallel to one another. Head (ears specifically) in line with shoulders.</p> <p>1.2 Hips at the surface of the water.</p> <p>2. 90° angle between the thigh of the bent leg and the surface of the water. An air pocket will be evident between the back of the thigh and calf of the bent leg and the surface of the water.</p>

BP 6 Vertical Position

Body Position Description	Diagrams	Major Desired Actions
<p>1. Body extended perpendicular to the surface of the water; legs together, head downward.</p> <p>2. Head (ears specifically), hips and ankles in line.</p>		<p>1. Full extension of the body.</p> <p>2. Judgement is made by checking visual points of the vertical alignment: ears, shoulder joints, hip joints and ankles.</p>

BP 16 Split Position

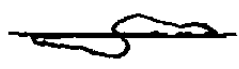

Body Position Description	Diagrams	Major Desired Actions
<p>1. Legs evenly split forward and back.</p> <p>2. The legs are parallel to the surface of the water.</p> <p>3. Lower back arched, with hips, shoulders and head on a vertical line.</p> <p>4. 180° angle between the extended legs (flat split), with inside of each leg aligned on opposite sides of a horizontal line, regardless of the height of the hips.</p>		<p>1. Full extension of the legs at or above the surface of the water.</p> <p>4. Flat split. Hip joints and shoulder joints on a horizontal line, with both of these alignments 'square' and parallel to each other.</p>


Figure – 437 CYCLONE OPEN 180° (cont.)

DIFFICULTY – 2.6

BP 16 Split Position (cont.)

Body Position Description	Diagrams	Major Desired Actions
<p>a) Surface Split Position</p> <p>1. Legs are dry at the surface of the water.</p>		<p>1. Full extension of the legs. Crotch and legs dry at the surface of the water.</p>

BP 13 Surface Arch Position

Body Position Description	Diagrams	Major Desired Actions
<p>1. Lower back arched with hips, shoulders and head on a vertical line.</p>		<p>1. Hip joints and shoulder joints on a horizontal line with both of these alignments 'square' and parallel to one another. Head (ears specifically) in line with shoulders.</p>
<p>2. Legs together and at the surface of the water.</p>		<p>2. Hips joints at the surface of the water.</p>

BM 15 To Assume a Bent Knee Surface Arch Position/A Bent Knee Surface Arch is Assumed




Basic Movement Description	NVT	Diagrams	Major Desired Actions
<p>1. From a Back Layout Position with the head leading, the head, hips and feet move along the surface of the water.</p>			<p>1. See BP 1 Back Layout Position.</p>
<p>2. With continuous movement the head leaves the surface of the water as the back is arched more to assume a Bent Knee Surface Arch Position with the hips occupying the position of the head at the beginning of this action.</p>	17.5		<p>2.1 Continuous uniform movement from the BP 1 Back Layout Position to BP 14d Bent Knee Surface Arch Position. Hip height remains constant. Hip joints on a horizontal line.</p> <p>2.2 The toe of the bent leg must remain in contact with the inside of the extended leg while assuming the Bent Knee Surface Arch Position.</p>

Figure – 437 CYCLONE OPEN 180° (cont.)

DIFFICULTY – 2.6

BM 12 *Twist*

Basic Movement Description	NVT	Diagrams	Major Desired Actions
<p>1. A <i>Twist</i> is a rotation at a sustained height.</p> <p>2. The body remains on its longitudinal axis throughout the rotation.</p>			<p>1. Height remains constant throughout the rotation. Stability and alignment of the position is evident before, during and upon completion of the <i>Twist</i>. The amount of height is judged by the relationship of the hip joints to the surface of the water with maximum height desirable.</p> <p>2. The longitudinal axis runs through the centre of the body and is perpendicular to the surface of the water. On the spot rotation around this axis.</p>
<p>c) <i>Twirl</i>: a rapid <i>Twist</i> of 180°. For 437 Cyclone Open 180° the <i>Twirl</i> starts in a BP 14d Bent Knee Surface Arch Position and is completed in the BP 6 Vertical Position.</p>	29.0		<p>c) The acceptable allowance for ½ <i>Twist</i> rotations is up to ¼ less than/more than the required rotation. Definite increase in speed from the root figure. Stability of body alignment and height remains constant during and after completion of the <i>Twirl</i>.</p>

BM 6 *Walkout*


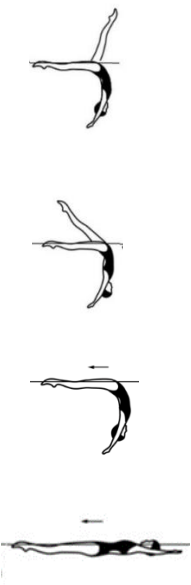
Basic Movement Description	NVT	Diagrams	Major Desired Actions
<p>1. These movements start in a Split Position unless otherwise specified in the figure description. The hips remain stationary as one leg is lifted in an arc over the surface of the water to meet the opposite leg.</p>			<p>1. See BP 16a Surface Split Position.</p>

Figure – 437 CYCLONE OPEN 180° (cont.)

DIFFICULTY – 2.6

BM 6 Walkout (cont.)

Basic Movement Description	NVT	Diagrams	Major Desired Actions
<p>a) Walkout Front</p> <p>2. The front leg is lifted in a 180° arc over the surface of the water to meet the opposite leg in a Surface Arch Position and with continuous movement an <i>Arch to Back Layout Finish Action</i> is executed.</p>	<p>23.0</p> <p>7.0</p>		<p>2.1 Hip height remains constant and at the surface of the water.</p> <p>2.2 Arcing leg moves continuously with uniform motion.</p> <p>2.3 Both legs maintain full extension.</p> <p>2.4 The trunk remains stationary until the feet join.</p> <p>2.5 No pause in BP 13 Surface Arch Position, however an accurate surface arch must be evident before the body begins to rise and straighten.</p> <p>2.6 Foot first surfacing motion begins when the feet are joined.</p> <p>2.7 See BP 13 Surface Arch Position and BM 5 <i>Arch to Back Layout Finish Action</i>.</p>

BM 5 Arch to Back Layout Finish Action

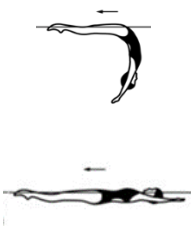
Basic Movement Description	NVT	Diagrams	Major Desired Actions
<p>1. From a Surface Arch Position the hips, chest and face surface sequentially at the same point with foot first movement to a Back Layout Position until the head occupies the position of the hips at the beginning of this action.</p>	<p>7.0</p>		<p>1. See BP 13 Surface Arch Position. Sharp arch in the lower back. The body rises, straightens and moves along the surface of the water with a stationary BP 1 Back Layout Position achieved as the face surfaces. Full extension maintained throughout.</p>

Figure – 438 OCEANEA

DIFFICULTY – 2.2

From a **Back Layout Position** a *Bent Knee Surface Arch Position* is assumed. The horizontal leg is lifted to vertical as the bent leg is extended to assume a **Vertical Position**. A *Continuous Spin of 720°* (2 rotations) is executed.





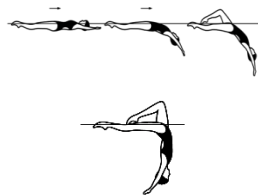
				Total
NVT=	17.5	21.0	34.0	72.5
PV =	2.41	2.90	4.69	10

Figure Description	NVT	Diagrams	Major Desired Actions
--------------------	-----	----------	-----------------------

1. From a **Back Layout Position** a *Bent Knee Surface Arch Position* is assumed.

17.5



1. See BP 1 **Back Layout Position**, BP 14d **Bent Knee Surface Arch Position** and BM 15 *To Assume A Bent Knee Surface Arch Position*. Continuous uniform movement from **Back Layout Position** to **Bent Knee Surface Arch Position**.

2. The horizontal leg is lifted to vertical as the bent leg is extended to assume a **Vertical Position**.


21.0



2.1 See BP 14d **Bent Knee Vertical Surface Arch Position** and BP 6 **Vertical Position**. Horizontal alignment of hips and shoulders 'square' and maintained during the lift.
 2.2 The bent leg straightens to **Vertical Position** simultaneously with completion of the feet joining. The bent leg is extended upward at the same rate of space and time as the vertical leg.
 2.3 The hips maintain constant height and are the pivot point for the lift to **Vertical Position**.

Figure – 438 OCEANEA (cont.)

DIFFICULTY – 2.2

Figure Description	NVT	Diagrams	Major Desired Actions
3. A <i>Continuous Spin of 720°</i> (2 rotations) is executed.	34.0		3. See BM 13f <i>Continuous Spin</i> .

See Figure 437 Cyclone Open 180° for **Back Layout Position, Bent Knee Surface Arch Position, Vertical Position** and BM 15 *To Assume a Bent Knee Surface Arch Position Basic Movement*.

Note: Refer to Section BM 13 Spins & Spin Allowances.

Figure – 439 OCEANITA

DIFFICULTY –1.8

From a **Back Layout Position** a *Bent Knee Surface Arch Position* is assumed. The horizontal leg is lifted to vertical as the bent leg is extended to assume a **Vertical Position**. A *Vertical Descent* is executed.





					Total
NVT=	17.5	21.0	14.0	52.5	
PV =	3.33	4.00	2.67	10	

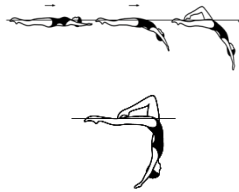
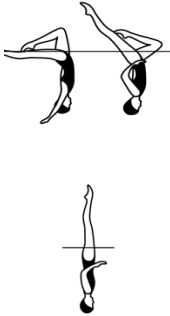

Figure Description	NVT	Diagrams	Major Desired Actions
1. From a Back Layout Position a <i>Bent Knee Surface Arch Position</i> is assumed.	17.5		1. See BP 1 Back Layout Position , BP 14d Bent Knee Surface Arch Position and BM 15 <i>To Assume A Bent Knee Surface Arch Position</i> . Continuous uniform movement from Back Layout Position to Bent Knee Surface Arch Position .

Figure – 439 OCEANITA (cont.)

DIFFICULTY –1.8

Figure Description	NVT	Diagrams	Major Desired Actions
<p>2. The horizontal leg is lifted to vertical as the bent leg is extended to assume a Vertical Position.</p>	21.0		<p>2.1 See BP 14d Bent Knee Vertical Surface Arch Position and BP 6 Vertical Position. Horizontal alignment of hips and shoulders 'square' and maintained during the lift.</p> <p>2.2 The bent leg straightens to Vertical Position simultaneously with completion of the feet joining The bent leg is extended upward at the same rate of space and time as the vertical leg.</p> <p>2.3 The hips maintain constant height and are the pivot point for the lift to Vertical Position.</p>
<p>3. A <i>Vertical Descent</i> is executed.</p>	14.0		<p>3. See BM 10 <i>Vertical Descent</i>.</p>

See Figure 437 Cyclone Open 180° for **Back Layout Position, Bent Knee Surface Arch Position, Vertical Position** and BM 15 *To Assume a Bent Knee Surface Arch Position Basic Movement*.

Figure – 440 IPANEMA

DIFFICULTY – 3.0

From a **Back Layout Position** a *Bent Knee Surface Arch Position* is assumed. The horizontal leg is lifted to vertical as the bent leg is straightened to assume a **Vertical Position**. The legs are lowered to a **Front Pike Position**. A rapid 180° rotation is executed as the legs are lifted to a **Vertical Position**. A *Vertical Descent* is executed.







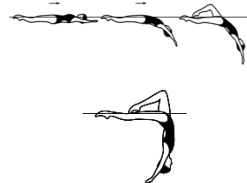
						Total
NVT=	17.5	21.0	33.0	33.0	14.0	118.5
PV =	1.48	1.77	2.78	2.78	1.18	10

Figure Description	NVT	Diagrams	Major Desired Actions
--------------------	-----	----------	-----------------------

1. From a **Back Layout Position** a *Bent Knee Surface Arch Position* is assumed.

17.5



1. See BP 1 **Back Layout Position**, BP 14d **Bent Knee Surface Arch Position** and BM 15 *To Assume A Bent Knee Surface Arch Position*. Continuous uniform movement from **Back Layout Position** to **Bent Knee Surface Arch Position**.

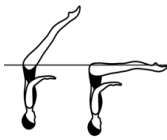


2. The horizontal leg is lifted to vertical as the bent leg is extended to assume a **Vertical Position**.

21.0



2.1 See BP 14d **Bent Knee Vertical Surface Arch Position** and BP 6 **Vertical Position**. Horizontal alignment of hips and shoulders 'square' and maintained during the lift.
 2.2 The bent leg straightens to **Vertical Position** simultaneously with completion of the feet joining. The bent leg is extended upward at the same rate of space and time of the vertical leg.
 2.3 The hips maintain constant height and are the pivot point for the lift to **Vertical Position**.

Figure – 440 IPANEMA (cont.)
DIFFICULTY – 3.0

Figure Description	NVT	Diagrams	Major Desired Actions
3. The legs are lowered to a Front Pike Position .	33.0		3. Without loss of height or horizontal alignment of head, hips and shoulders, the legs are lowered to BP 10 Front Pike Position .
4. A rapid 180° rotation is executed as the legs are lifted to a Vertical Position .	33.0		4. Without loss of height, the body rapidly rotates 180° as it straightens to BP 6 Vertical Position . At the halfway point of the rotation the legs are at a 45° angle to the surface of the water.
5. A <i>Vertical Descent</i> is executed.	14.0		5. See BM 10 <i>Vertical Descent</i> . The descent is uniform and at the same tempo as the start of the figure until the BP 10 Front Pike Position .

BP 1 Back Layout Position



Body Position Description	Diagrams	Major Desired Actions
1. Body extended with face, chest, thighs and feet at the surface of the water.		1. Gives the impression that the body is stretched horizontally to its maximum. Front of the trunk will also be at the surface of the water.
2. Head (ears specifically), hips and ankles in horizontal alignment.		2. Judgement is made by checking visual points of the horizontal alignment: ears, shoulder joints, hip joints and ankles. This imaginary line should also pass through the middle of the side of the trunk.


Figure – 440 IPANEMA (cont.)

DIFFICULTY – 3.0

BP 14 Bent Knee Position

Body Position Description	Diagrams	Major Desired Actions
<p>One leg bent with the toe of the bent leg in contact with the inside of the extended leg at the knee or higher.</p>		<p>The relationship of the toe of the bent leg to the extended leg may vary depending on the figure but should remain constant once established, and not extend in front of or behind the extended leg.</p>
<p>d) Bent Knee Surface Arch Position</p>		
<p>1. Lower back arched with hips, shoulders and head on a vertical line.</p>		<p>1.1 In BP 13 Surface Arch Position shoulder joints and hip joints on a horizontal line with both of these alignments 'square' and parallel to one another. Head (ears specifically) in line with shoulders. 1.2 Hips at the surface of the water.</p>
<p>2. The thigh of the bent leg is perpendicular to the surface of the water.</p>		<p>2. 90° angle between the thigh of the bent leg and the surface of the water. An air pocket will be evident between the back of the thigh and calf of the bent leg and the surface of the water.</p>

BP 6 Vertical Position

Body Position Description	Diagrams	Major Desired Actions
<p>1. Body extended perpendicular to the surface of the water; legs together, head downward.</p>		<p>1. Full extension of the body.</p>
<p>2. Head (ears specifically), hips and ankles in line.</p>		<p>2. Judgement is made by checking visual points of the vertical alignment: ears, shoulder joints, hip joints and ankles.</p>

BP 10 Front Pike Position


Body Position Description	Diagrams	Major Desired Actions
<p>1. Body bent at hips to form a 90° angle.</p>		<p>1. Exact 90° angle.</p>

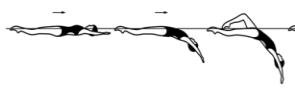

Figure – 440 IPANEMA (cont.)

DIFFICULTY – 3.0

BP 10 Front Pike Position (cont.)

Body Position Description	Diagrams	Major Desired Actions
2. Legs extended and together.		2. Full extension of legs, with ankles aligned with hip joints.
3. Trunk extended with the back straight and head in line.		3. Back flat, with vertical alignment of ears, shoulder joints and hip joints once the position is established.

BM 15 To Assume a Bent Knee Surface Arch Position / A Bent Knee Surface Arch is Assumed

Basic Movement Description	NVT	Diagrams	Major Desired Actions
1. From a Back Layout Position with the head leading, the head, hips and feet move along the surface of the water.			1. See BP 1 Back Layout Position .
2. With continuous movement the head leaves the surface of the water as the back is arched more to assume a Bent Knee Surface Arch Position with the hips occupying the position of the head at the beginning of this action.	17.5		2.1 Continuous uniform movement from the BP 1 Back Layout Position to BP 14d Bent Knee Surface Arch Position . Hip height remains constant. Hip joints on a horizontal line. 2.2 The toe of the bent leg must remain in contact with the inside of the extended leg while assuming the Bent Knee Surface Arch Position .

BM 10 Vertical Descent

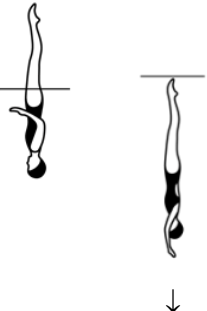
Basic Movement Description	NVT	Diagrams	Major Desired Actions
1. Maintaining a Vertical Position the body descends along its longitudinal axis until the toes are submerged.	14.0		1. See BP 6 Vertical Position . The descent is uniform and at the same tempo as the start of the figure until the BP 10 Front Pike Position .

Figure – 440 IPANEMA

Ipanema 440d – An Ipanema is executed until the completion of the second **Vertical Position**. Continuing in the same direction the designated rapid *Spin* is executed.

Note: Refer to Section BM 13 Spins & Spin Allowances.

Figure – 440d IPANEMA SPINNING 180°
DIFFICULTY – 3.1








								Total
NVT=		17.5	21.0	33.0	33.0	19.0	0	123.5
PV =		1.42	1.70	2.67	2.67	1.54	0	10

Figure – 441 SATURN

DIFFICULTY – 2.5

From a **Back Layout Position** a *Surface Arch Position* is assumed. One leg is lifted to assume a **Knight Position**. Maintaining the vertical alignment the body rotates 180° to assume a **Fishtail Position**. Continuing in the same direction a *Twirl* is executed as the horizontal leg is lifted to a **Vertical Position**. A *Vertical Descent* is executed.







						Total
NVT=	12.0	23.5	14.0	23.5	14.0	87
PV =	1.38	2.70	1.61	2.70	1.61	10

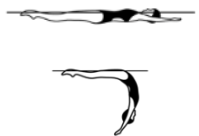




Figure Description	NVT	Diagrams	Major Desired Actions
1. From a Back Layout Position a <i>Surface Arch Position</i> is assumed.	12.0		1. See BP 1 Back Layout Position , BP 13 Surface Arch Position and BM 14 <i>To Assume A Surface Arch Position</i> . Continuous uniform movement from Back Layout Position to Surface Arch Position .
2. One leg is lifted to assume a Knight Position .	23.5		2.1 See BP 17 Knight Position . Horizontal alignment of hips and shoulders 'square' and maintained throughout the lift to Knight Position . 2.2 Height and full extension of the legs maintained throughout the lifting of the leg.
3. Maintaining the vertical alignment the body rotates 180° to assume a Fishtail Position .	14.0		3.1 See BP 8 Fishtail Position . The vertical leg remains stationary and height remains constant throughout the rotation. 3.2 The foot of the horizontal leg is at the surface of the water and not above or below the surface of the water. 3.3 Full extension of both legs throughout the 180° rotation.

Figure – 441 SATURN (cont.)

DIFFICULTY – 2.5

Figure Description	NVT	Diagrams	Major Desired Actions
4. Continuing in the same direction a <i>Twirl</i> is executed as the horizontal leg is lifted to a Vertical Position .	23.5		<p>4.1 See BP 6 Vertical Position and BM 12c <i>Twirl</i>. Trunk alignment maintained beneath hips and shoulders.</p> <p>4.2 Hips and shoulders aligned horizontally and 'square'.</p> <p>4.3 The lifting of the horizontal leg to Vertical Position and the completion of the <i>Twirl</i> occur simultaneously.</p> <p>4.4 A rapid 180° rotation is executed with minimal lateral movement.</p>
5. A <i>Vertical Descent</i> is executed.	14.0		5. See BM 10 <i>Vertical Descent</i> performed at the same tempo as the beginning of the figure to the Fishtail Position .

BP 1 Back Layout Position



Body Position Description	Diagrams	Major Desired Actions
1. Body extended with face, chest, thighs and feet at the surface of the water.		1. Gives the impression that the body is stretched horizontally to its maximum. Front of the trunk will also be at the surface of the water.
2. Head (ears specifically), hips and ankles in horizontal alignment.		2. Judgement is made by checking visual points of the horizontal alignment: ears, shoulder joints, hip joints and ankles. This imaginary line should also pass through the middle of the side of the trunk.

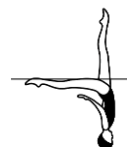
Figure – 441 SATURN (cont.)

DIFFICULTY – 2.5

BP 13 Surface Arch Position

Body Position Description	Diagrams	Major Desired Actions
<p>1. Lower back arched with hips, shoulders and head on a vertical line.</p>		<p>1. Hip joints and shoulder joints on a horizontal line with both of these alignments 'square' and parallel to one another. Head (ears specifically) in line with shoulders.</p> <p>2. Hips joints at the surface of the water.</p>

BP 17 Knight Position

Body Position Description	Diagrams	Major Desired Actions
<p>1. Lower back arched, with hips, shoulders and head on a vertical line.</p>		<p>1. Arch is in the lower part of the spine only.</p> <p>2. Vertical alignment through ears, shoulder joints, hip joints and ankle of the vertical leg.</p> <p>3. Hip joints and shoulder joints on a horizontal line with both of these alignments 'square' and parallel to each other. The top of the horizontal extended leg faces upward.</p>
<p>2. One leg vertical.</p>		
<p>3. Other leg extended backward with the leg at the surface of the water and as close to horizontal as possible.</p>		

BP 8 Fishtail Position



Body Position Description	Diagrams	Major Desired Actions
<p>1. Body extended in Vertical Position with one leg extended forward. The foot of the forward leg is at the surface of the water regardless of the height of the hips.</p>		<p>1. See BP 6 Vertical Position for body alignment. The foot of the forward leg must be at the surface of the water. Hip joints must be on a horizontal line.</p>



Figure – 441 SATURN (cont.)

DIFFICULTY – 2.5

BP 6 Vertical Position

Body Position Description	Diagrams	Major Desired Actions
1. Body extended perpendicular to the surface of the water; legs together, head downward.		1. Full extension of the body.
2. Head (ears specifically), hips and ankles in line.		2. Judgement is made by checking visual points of the vertical alignment: ears, shoulder joints, hip joints and ankles.

BM 14 To Assume a Surface Arch Position/A Surface Arch Position is Assumed

Basic Movement Description	NVT	Diagrams	Major Desired Actions
1. From a Back Layout Position with the head leading, the head, hips and feet move along the surface of the water.			1. See BP 1 Back Layout Position .
2. With continuous movement the head leaves the surface of the water as the back is arched more to assume a Surface Arch Position with the hips occupying the position of the head at the beginning of this action.	12.0		2. Continuous uniform movement from the BP 1 Back Layout Position to BP 13 Surface Arch Position . Hip height remains constant. Hip joints on a horizontal line.

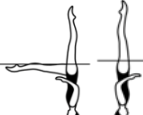
BM 12 Twists

Basic Movement Description	NVT	Diagrams	Major Desired Actions
1. A <i>Twist</i> is a rotation at a sustained height.			1. Height remains constant throughout the rotation. Stability and alignment of the position is evident before, during and upon completion of the <i>Twist</i> . The amount of height is judged by the relationship of the hip joints to the surface of the water with maximum height desirable.

Figure – 441 SATURN (cont.)

DIFFICULTY – 2.5

BM 12 Twists (cont.)

Basic Movement Description	NVT	Diagrams	Major Desired Actions
<p>2. The body remains on its longitudinal axis throughout the rotation.</p>			<p>2. The longitudinal axis runs through the centre of the body and is perpendicular to the surface of the water. On the spot rotation around this axis.</p>
<p>c) Twirl: a rapid <i>Twist</i> of 180°. For 441 Saturn the <i>Twirl</i> starts in a BP 8 Fishtail Position and is completed in the BP 6 Vertical Position.</p>	<p>29.0</p>		<p>c) The acceptable allowance for ½ <i>Twist</i> rotations is up to ¼ less than/more than the required rotation.</p> <p>Definite increase in speed from the root figure. Stability of body alignment and height remains constant throughout and after completion of the <i>Twirl</i>.</p>

BM 10 Vertical Descent


Basic Movement Description	NVT	Diagrams	Major Desired Actions
<p>1. Maintaining a Vertical Position the body descends along its longitudinal axis until the toes are submerged.</p>	<p>14.0</p>		<p>1. See BP 6 Vertical Position. The descent is uniform and at the same tempo as the beginning of the figure to the Fishtail Position.</p>








Figure – 441 SATURN (cont.)

Saturn 441e – A Saturn is executed until the **Vertical** Position. A rapid **360° Spin** is executed in the same direction as the *Twirl*.

Note: Refer to Section BM 12 Twists & Twist Allowances and Section BM 13 Spins & Spin Allowances

Figure – 441e SATURN SPINNING 360°

DIFFICULTY – 2.6

							Total
NVT=	12.0	23.5	14.0	23.5	23.0	0	96
PV =	1.25	2.45	1.46	2.45	2.40	0	10



Artistic Swimming Figures Manual

2022 – 2025

Part 3

Photo Library

CATEGORY I

Figure - 101 BALLET LEG SINGLE DIFFICULTY – 1.6



Figure - 102 BALLET LEG ALTERNATE DIFFICULTY – 2.4



Figure - 103 SUBMERGED BALLET LEG SINGLE DIFFICULTY – 2.1

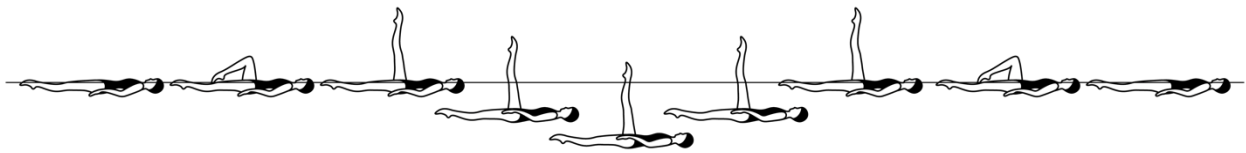


Figure - 106 STRAIGHT BALLET LEG DIFFICULTY – 1.6



Figure - 110 BALLET LEG DOUBLE DIFFICULTY – 1.6

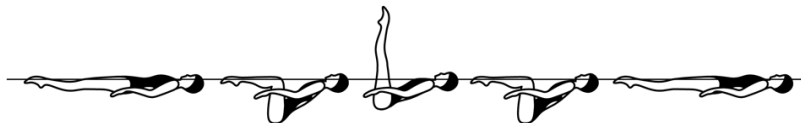


Figure - 111 SUBMARINE BALLET LEG DOUBLE DIFFICULTY – 2.2

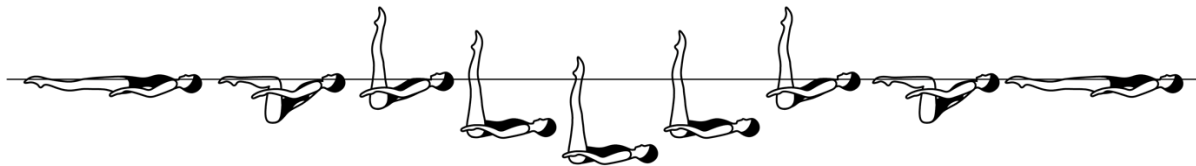


Figure - 112 IBIS DIFFICULTY – 2.5

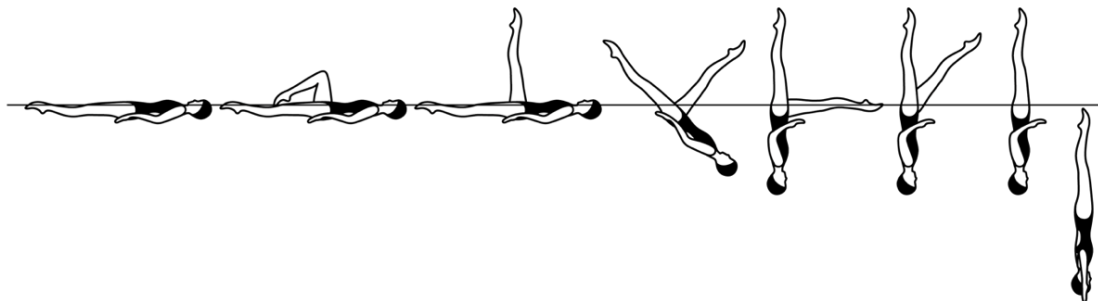


Figure – 112a IBIS 1/2 TWIST

DIFFICULTY – 2.9

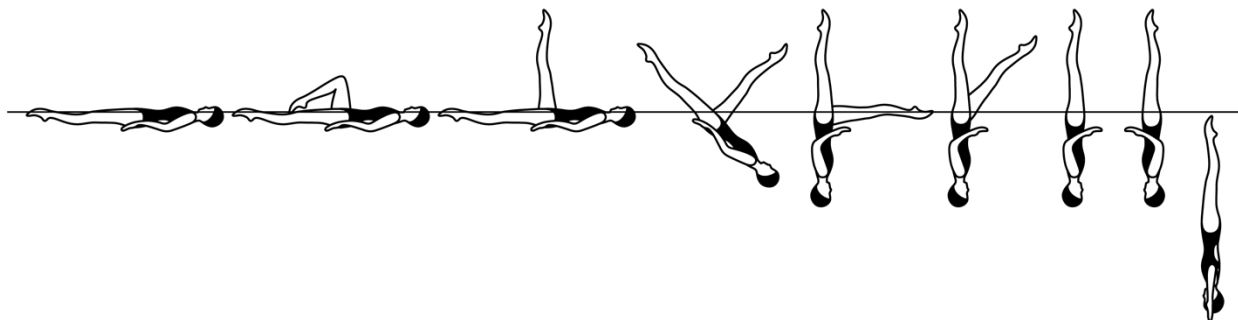


Figure – 112b IBIS FULL TWIST

DIFFICULTY – 3.1

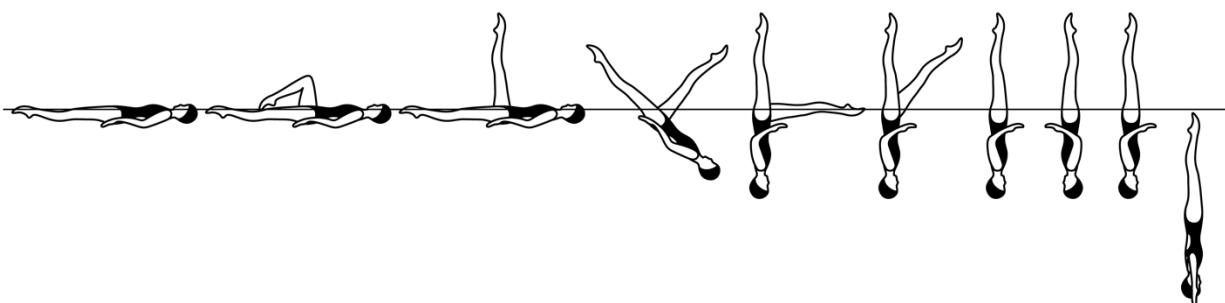


Figure – 112c IBIS TWIRL

DIFFICULTY – 3.0

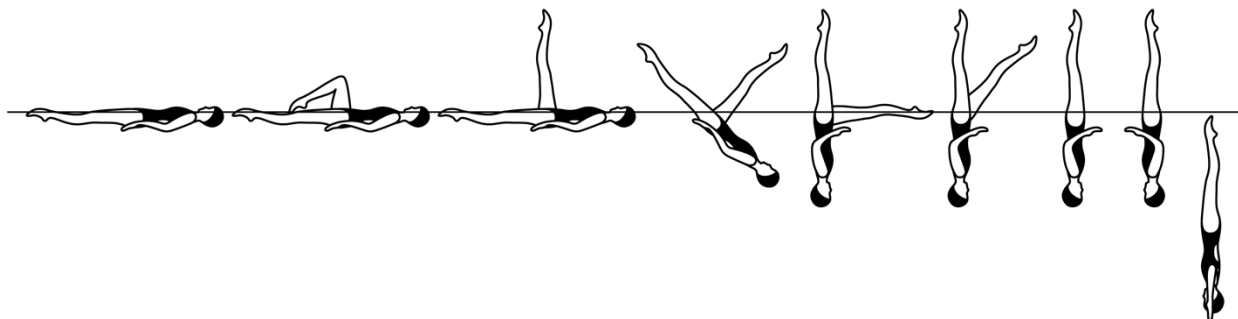


Figure – 112d IBIS SPINNING 180°

DIFFICULTY – 2.5

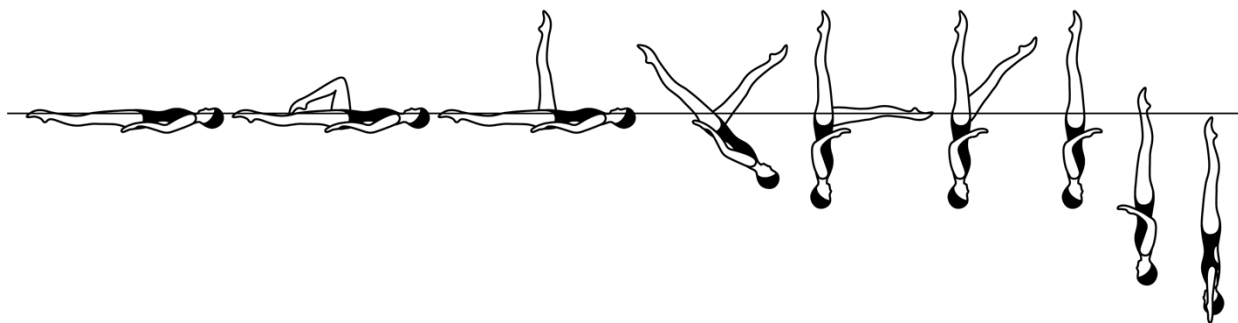


Figure – 112e IBIS SPINNING 360°

DIFFICULTY – 2.6

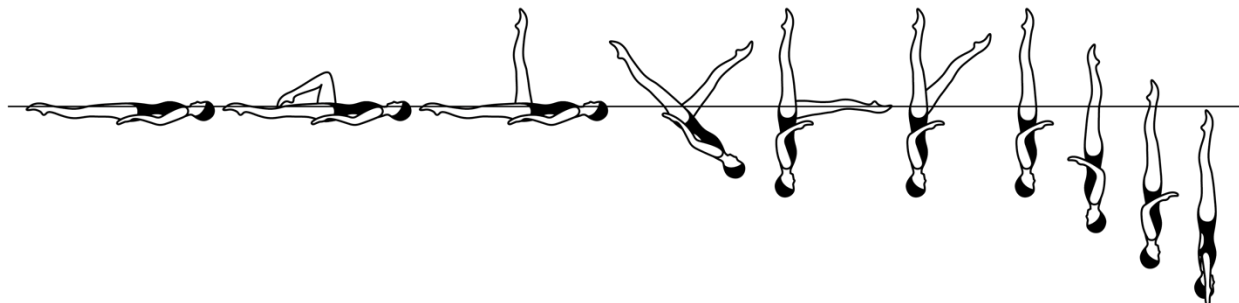


Figure – 112f IBIS CONTINUOUS SPIN (720°)

DIFFICULTY – 2.9

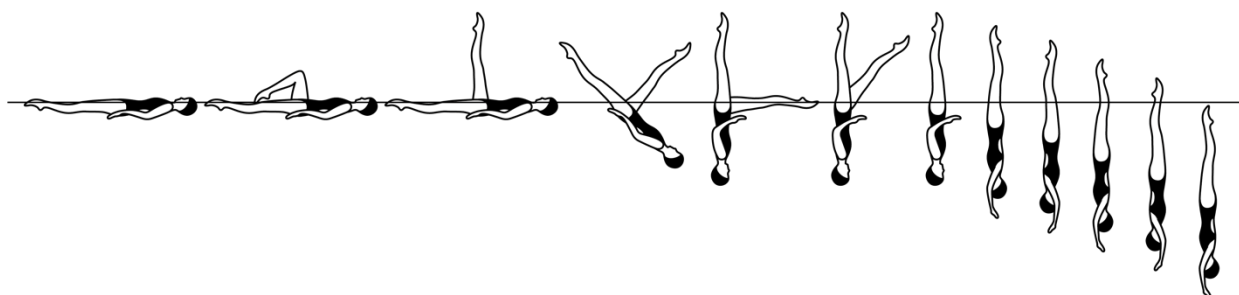


Figure – 112g IBIS TWIST SPIN

DIFFICULTY – 3.1

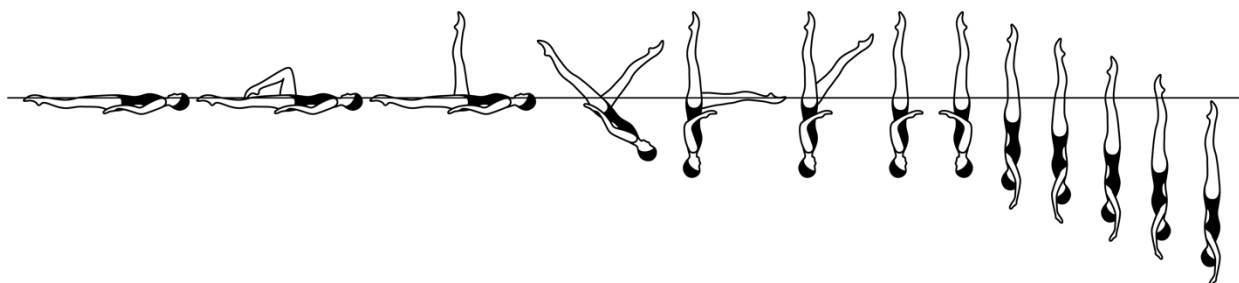


Figure – 112h IBIS SPIN UP 180°

DIFFICULTY – 3.1

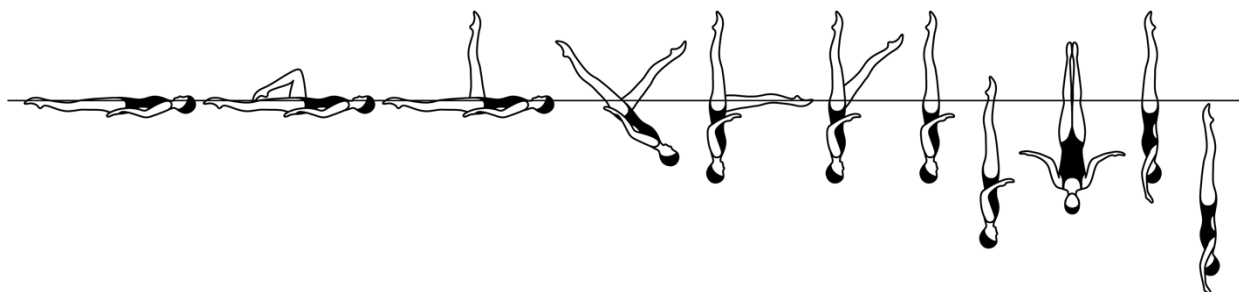


Figure – 112i IBIS SPIN UP 360°

DIFFICULTY – 3.1

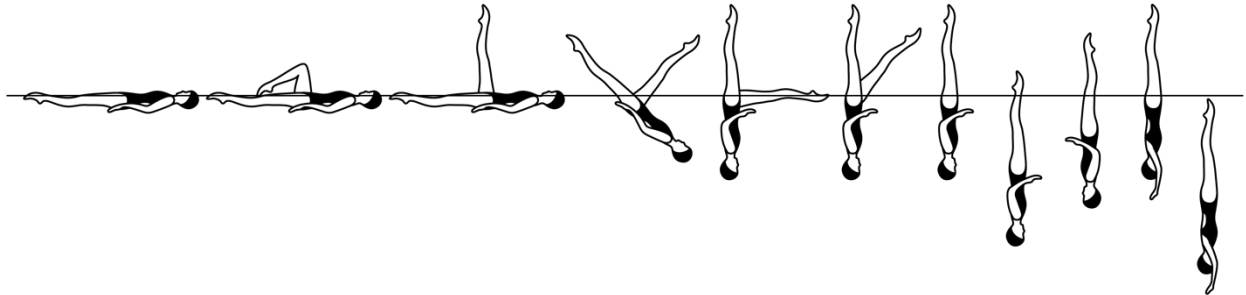


Figure – 112j IBIS COMBINED SPIN (360°+360°)

DIFFICULTY – 3.2

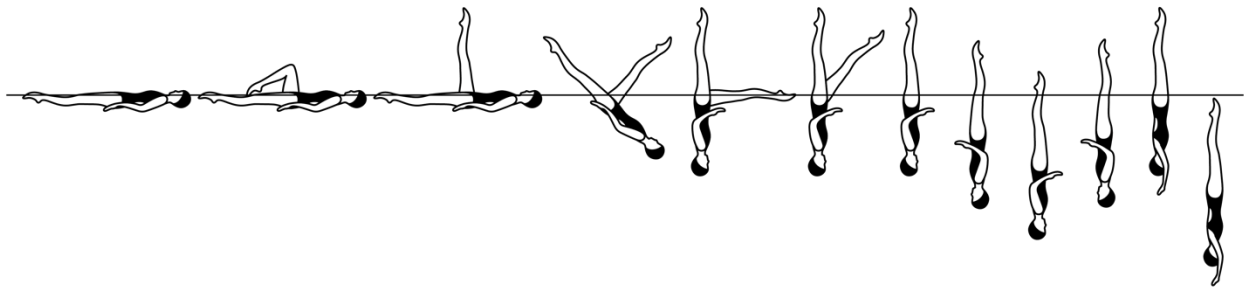


Figure – 113 CRANE

DIFFICULTY – 3.7

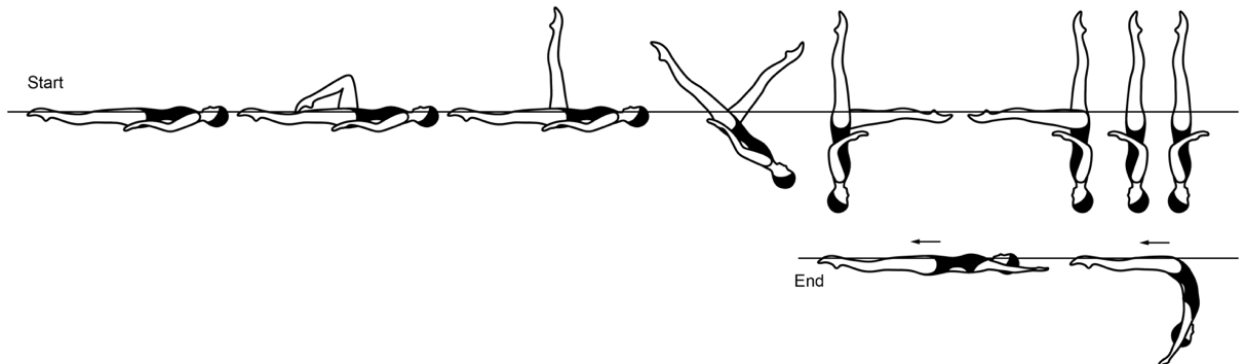


Figure - 115 CATALINA

DIFFICULTY – 2.3

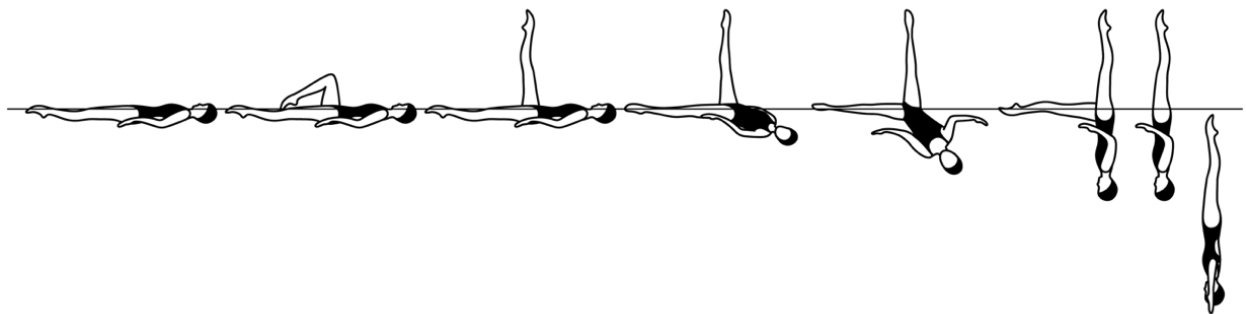


Figure – 115a CATALINA 1/2 TWIST DIFFICULTY – 2.7
See 112a IBIS for 1/2 TWIST

Figure – 115b CATALINA FULL TWIST DIFFICULTY – 2.9
See 112b IBIS for FULL TWIST

Figure – 115c CATALINA TWIRL DIFFICULTY – 2.8
See 112c IBIS for TWIRL

Figure – 115d CATALINA SPINNING 180° DIFFICULTY – 2.4
See 112d IBIS for SPINNING 180°

Figure – 115e CATALINA SPINNING 360° DIFFICULTY – 2.4
See 112e IBIS for SPINNING 360°

Figure – 115f CATALINA CONTINUOUS SPIN (720°) DIFFICULTY – 2.7
See 112f IBIS for CONTINUOUS SPIN (720°)

Figure – 115g CATALINA TWIST SPIN DIFFICULTY – 2.9
See 112g IBIS for TWIST SPIN

Figure – 115h CATALINA SPIN UP 180° DIFFICULTY – 2.9
See 112h IBIS for SPIN UP 180°

Figure – 115i CATALINA SPIN UP 360° DIFFICULTY – 3.0
See 112i IBIS for SPIN UP 360°

Figure – 115j CATALINA COMBINED SPIN (360°+360°) DIFFICULTY – 3.1
See 112j IBIS for COMBINED SPIN (360°+360°)

Figure - 116 CATALARC DIFFICULTY – 2.9

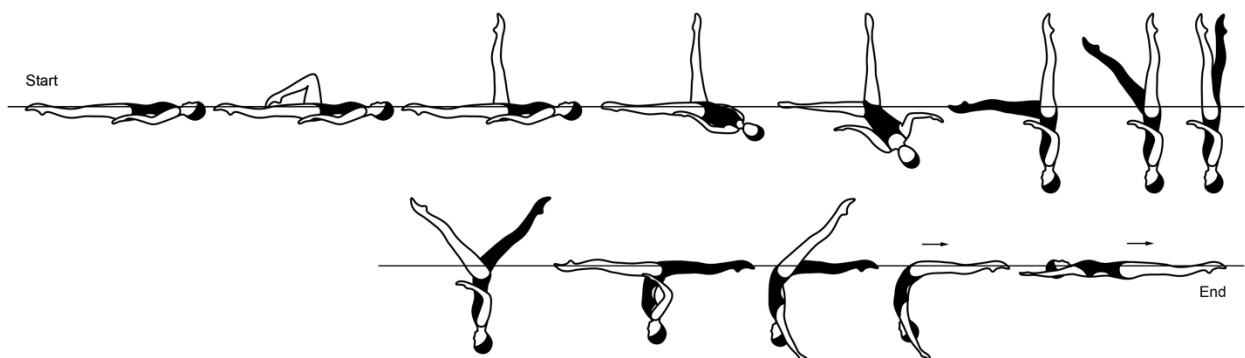


Figure - 117 CATALARC OPEN 180°

DIFFICULTY – 3.0

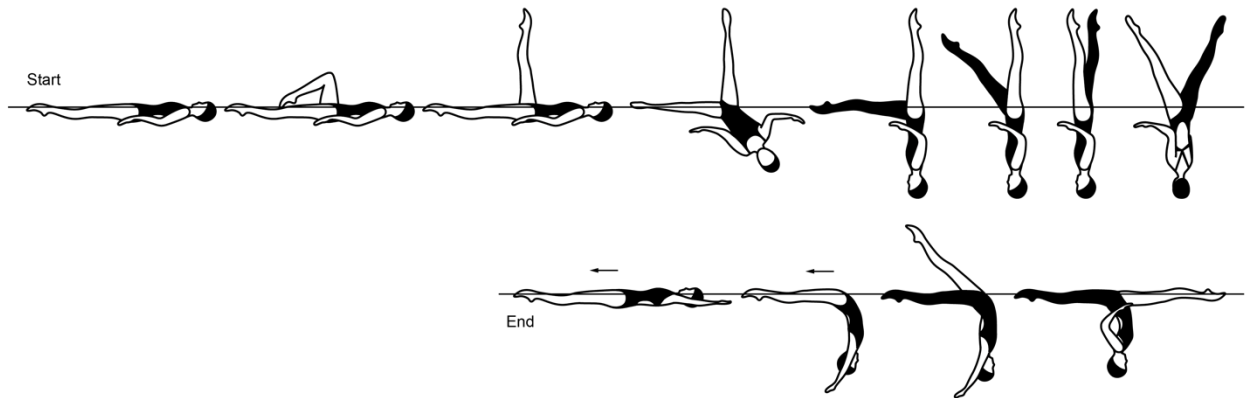


Figure - 118 HELICOPTER

DIFFICULTY – 2.0

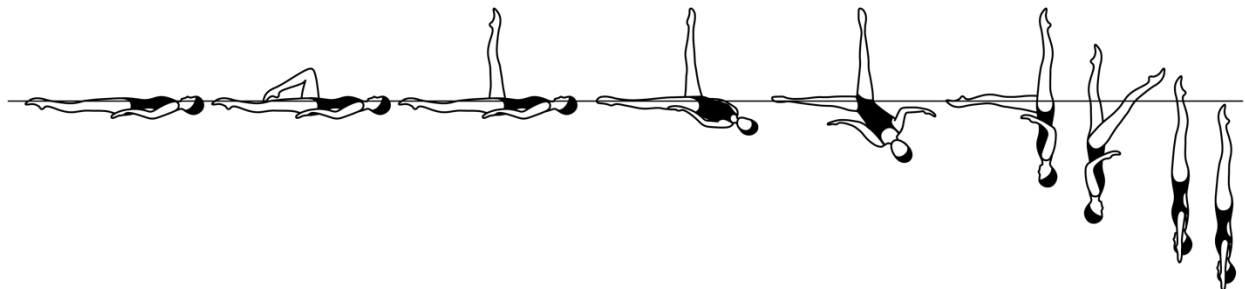


Figure - 125 EIFFEL TOWER

DIFFICULTY – 2.6

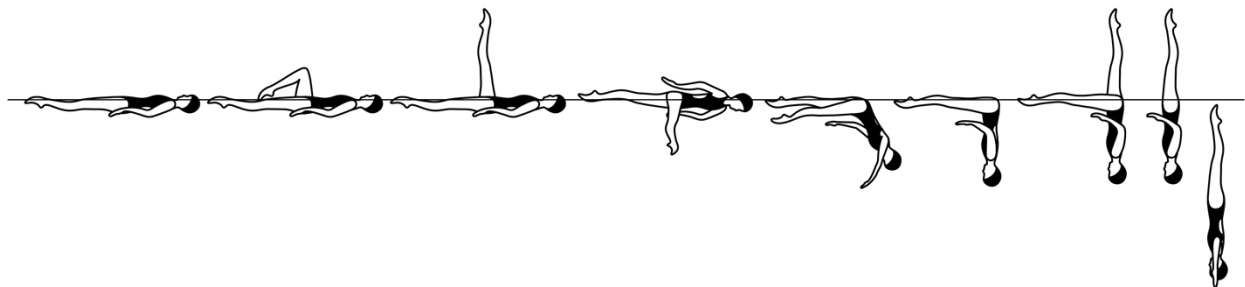


Figure – 125a EIFFEL TOWER 1/2 TWIST
See 112a IBIS for 1/2 TWIST

DIFFICULTY – 3.0

Figure – 125b EIFFEL TOWER FULL TWIST
See 112b IBIS for FULL TWIST

DIFFICULTY – 3.2

Figure – 125c EIFFEL TOWER TWIRL
See 112c IBIS TOWER for TWIRL

DIFFICULTY – 3.1

Figure – 125d EIFFEL TOWER SPINNING 180°
See 112d IBIS for SPINNING 180°

DIFFICULTY – 2.7

Figure – 125e EIFFEL TOWER SPINNING 360°
See 112e IBIS for SPINNING 360°

DIFFICULTY – 2.7

Figure – 125f EIFFEL TOWER CONTINUOUS SPIN (720°)
See 112f IBIS for CONTINUOUS SPIN (720°)

DIFFICULTY – 3.0

Figure – 125g EIFFEL TOWER TWIST SPIN
See 112g IBIS for TWIST SPIN

DIFFICULTY – 3.3

Figure – 125h EIFFEL TOWER SPIN UP 180°
See 112h IBIS for SPIN UP 180°

DIFFICULTY – 3.3

Figure – 125i EIFFEL TOWER SPIN UP 360°
See 112i IBIS for SPIN UP 360°

DIFFICULTY – 3.3

Figure - 128 EIFFEL WALK

DIFFICULTY – 2.7

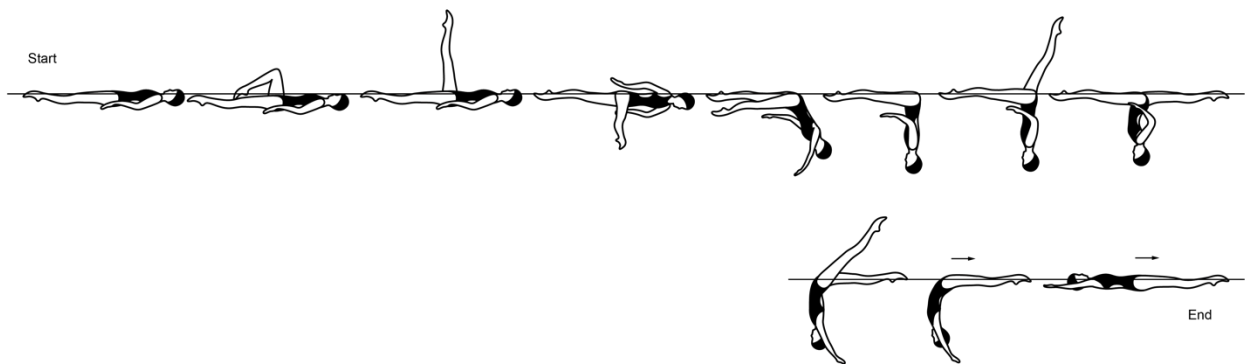


Figure - 130 FLAMINGO

DIFFICULTY – 2.4

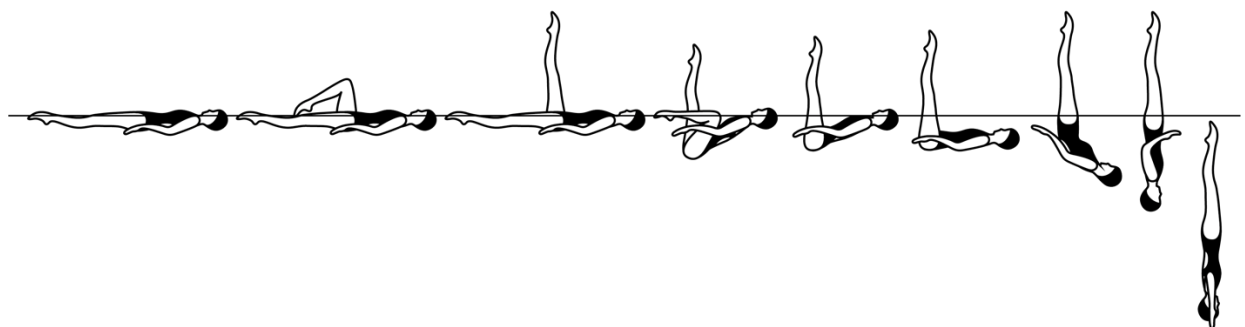


Figure – 130a FLAMINGO 1/2 TWIST
See 112a IBIS for 1/2 TWIST

DIFFICULTY – 2.8

Figure – 130b FLAMINGO FULL TWIST
See 112b IBIS for FULL TWIST

DIFFICULTY – 3.0

Figure – 130c **FLAMINGO TWIRL** **DIFFICULTY – 2.9**
See 112c IBIS for TWIRL

Figure – 130d **FLAMINGO SPINNING 180°** **DIFFICULTY – 2.4**
See 112d IBIS for SPINNING 180°

Figure – 130e **FLAMINGO SPINNING 360°** **DIFFICULTY – 2.5**
See 112e IBIS for SPINNING 360°

Figure – 130f **FLAMINGO CONTINUOUS SPIN (720°)** **DIFFICULTY – 2.8**
See 112f IBIS for CONTINUOUS SPIN (720°)

Figure – 130g **FLAMINGO TWIST SPIN** **DIFFICULTY – 3.0**
See 112g IBIS for TWIST SPIN

Figure – 130h **FLAMINGO SPIN UP 180°** **DIFFICULTY – 3.0**
See 112h IBIS for SPIN UP 180°

Figure – 130i **FLAMINGO SPIN UP 360°** **DIFFICULTY – 3.0**
See 112i IBIS for SPIN UP 360°

Figure – 130j **FLAMINGO COMBINED SPIN (360°+360°)** **DIFFICULTY – 3.1**
See 112i IBIS for COMBINED SPIN (360°+360°)

Figure - 140 **FLAMINGO BENT KNEE** **DIFFICULTY – 2.3**

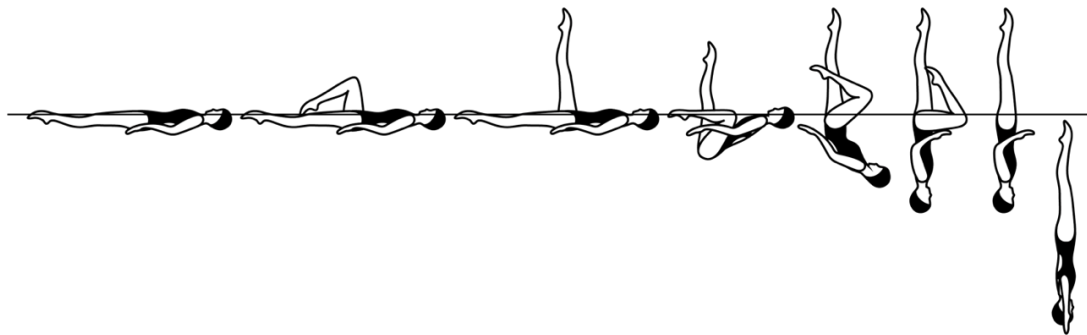


Figure – 140a **FLAMINGO BENT KNEE 1/2 TWIST** **DIFFICULTY – 2.7**
See 112a IBIS for 1/2 TWIST

Figure – 140b **FLAMINGO BENT KNEE FULL TWIST** **DIFFICULTY – 2.9**
See 112b IBIS for FULL TWIST

Figure – 140c **FLAMINGO BENT KNEE TWIRL** **DIFFICULTY – 2.8**
See 112c IBIS for TWIRL

Figure – 140d FLAMINGO BENT KNEE SPINNING 180° DIFFICULTY – 2.4
See 112d IBIS for SPINNING 180°

Figure – 140e FLAMINGO BENT KNEE SPINNING 360° DIFFICULTY – 2.4
See 112e IBIS for SPINNING 360°

Figure – 140f FLAMINGO BENT KNEE CONTINUOUS SPIN (720°) DIFFICULTY – 2.7
See 112f IBIS for CONTINUOUS SPIN (720°)

Figure – 140g FLAMINGO BENT KNEE TWIST SPIN DIFFICULTY – 2.9
See 112g IBIS for TWIST SPIN

Figure – 140h FLAMINGO BENT KNEE SPIN UP 180° DIFFICULTY – 2.9
See 112h IBIS for SPIN UP 180°

Figure – 140i FLAMINGO BENT KNEE SPIN UP 360° DIFFICULTY – 3.0
See 112i IBIS for SPIN UP 180°

Figure – 140j FLAMINGO BENT KNEE COMBINED SPIN (360°+360°) DIFFICULTY – 3.1
See 112j IBIS for COMBINED SPIN (360°+360°)

Figure - 141 STINGRAY DIFFICULTY – 3.1

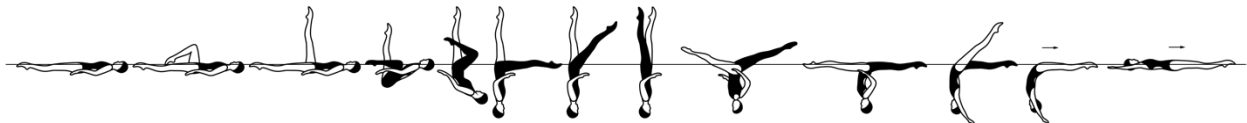


Figure - 142 MANTA RAY DIFFICULTY – 2.8

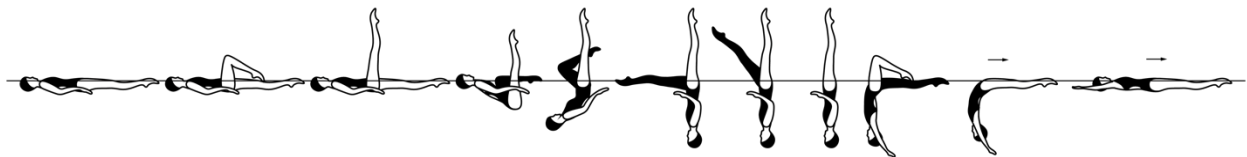


Figure - 143 RIO DIFFICULTY – 3.1

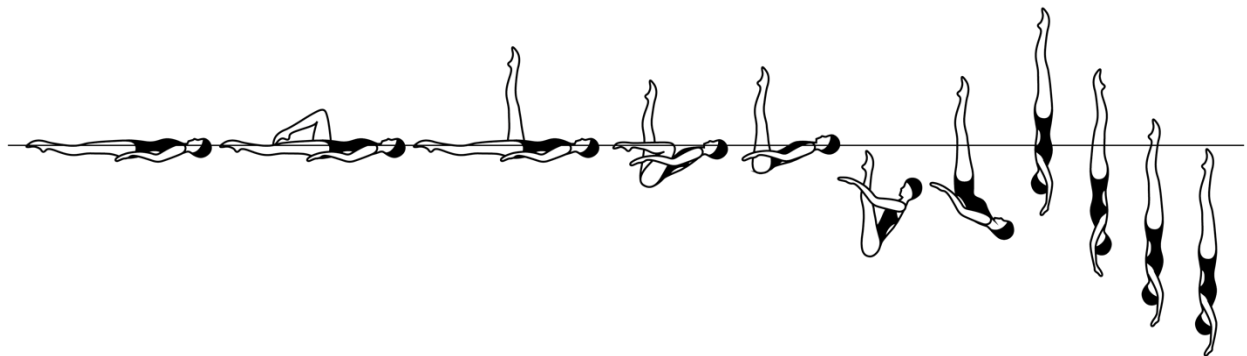


Figure - 144 RIO STRAIGHT LEG

DIFFICULTY - 3.1

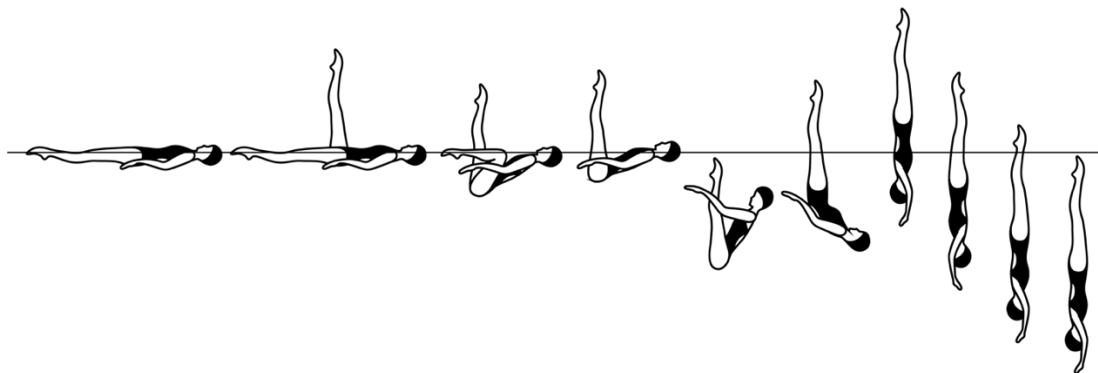


Figure - 150 KNIGHT

DIFFICULTY - 3.1

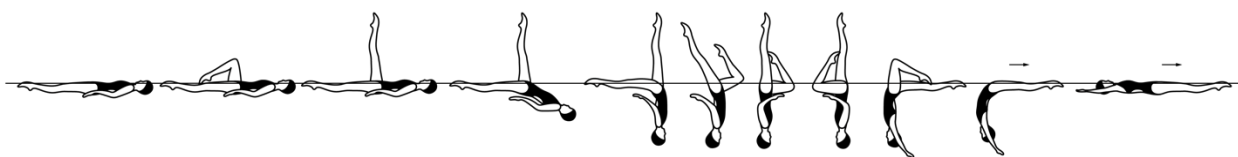


Figure - 154 LONDON

DIFFICULTY - 2.0

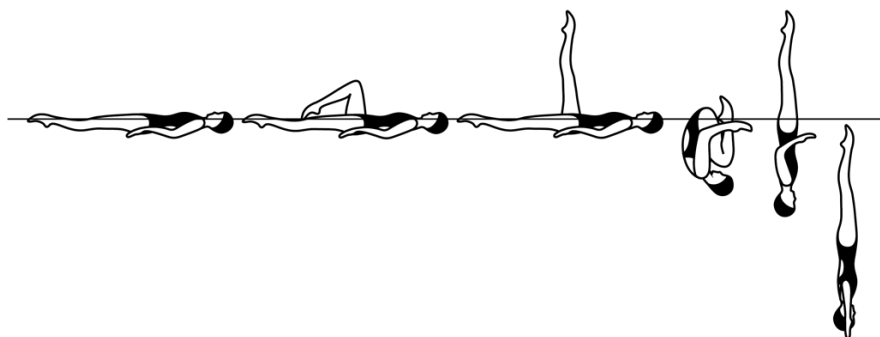


Figure - 154j-1 LONDON COMBINED SPIN (360°+360°)

DIFFICULTY - 2.7

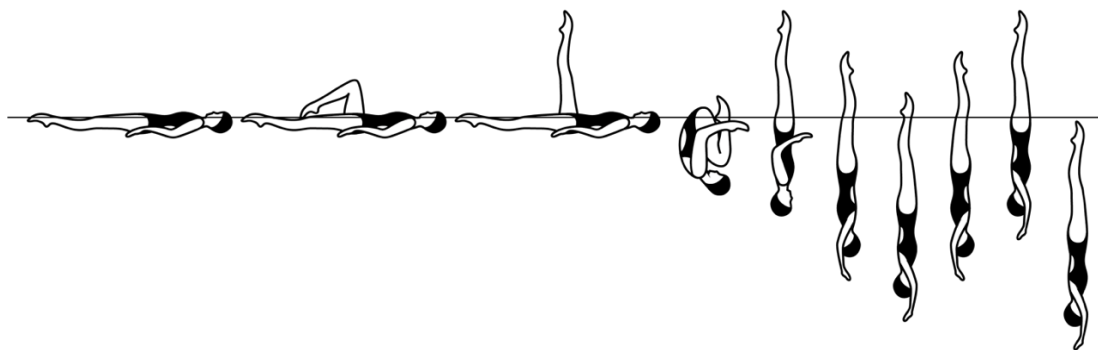
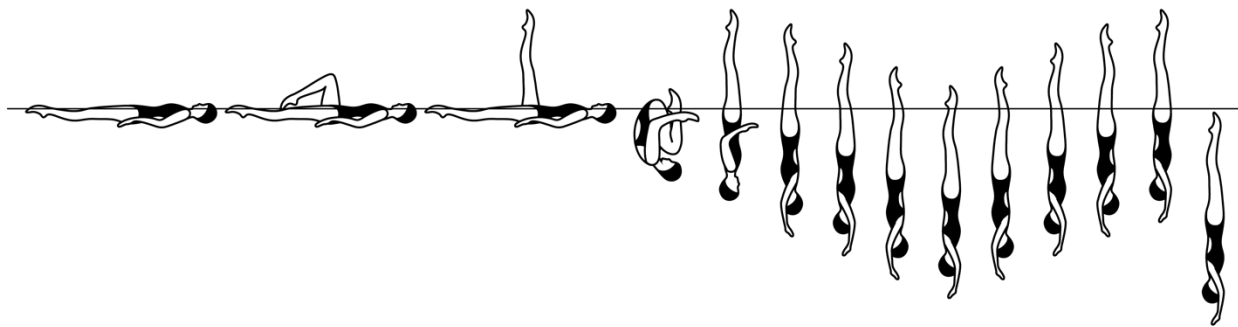


Figure – 154j-2 LONDON COMBINED SPIN ($720^{\circ}+720^{\circ}$)

DIFFICULTY – 2.9



CATEGORY II

Figure - 226 SWAN

DIFFICULTY – 2.1

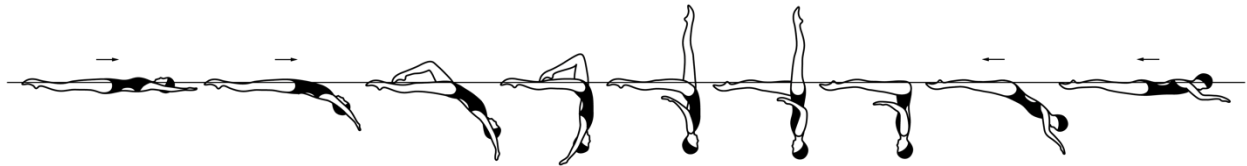


Figure - 227 SWANITA

DIFFICULTY – 1.8

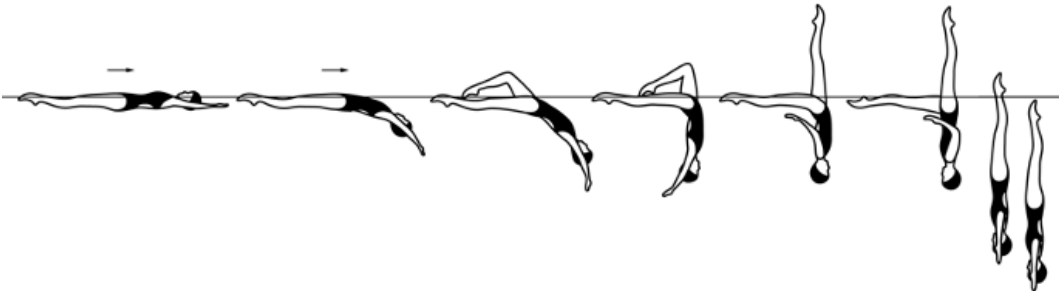


Figure – 227d SWANITA SPINNING 180°

DIFFICULTY – 1.9

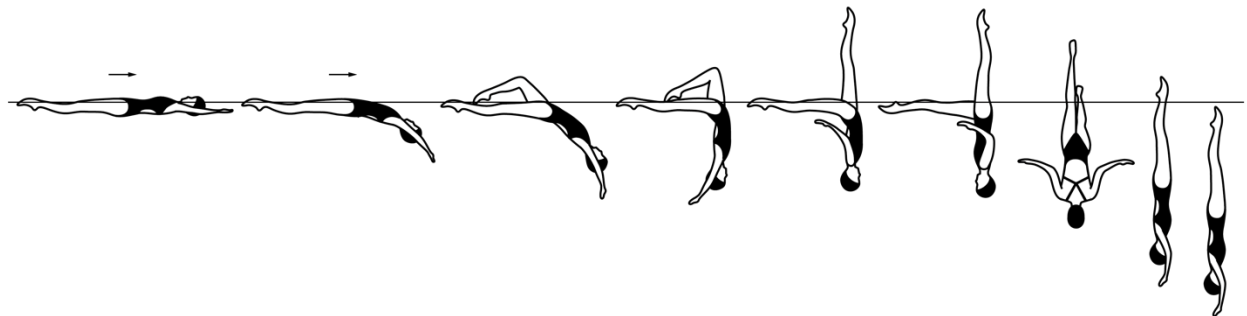


Figure - 240 ALBATROSS

DIFFICULTY – 2.2

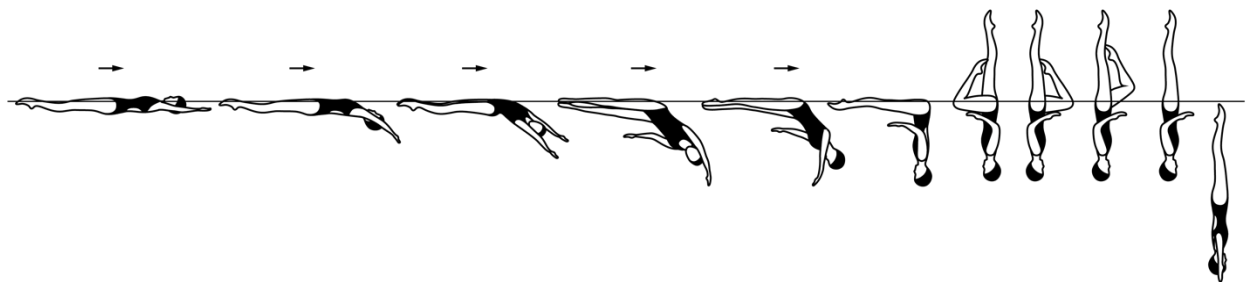


Figure – 240a ALBATROSS 1/2 TWIST

DIFFICULTY – 2.2

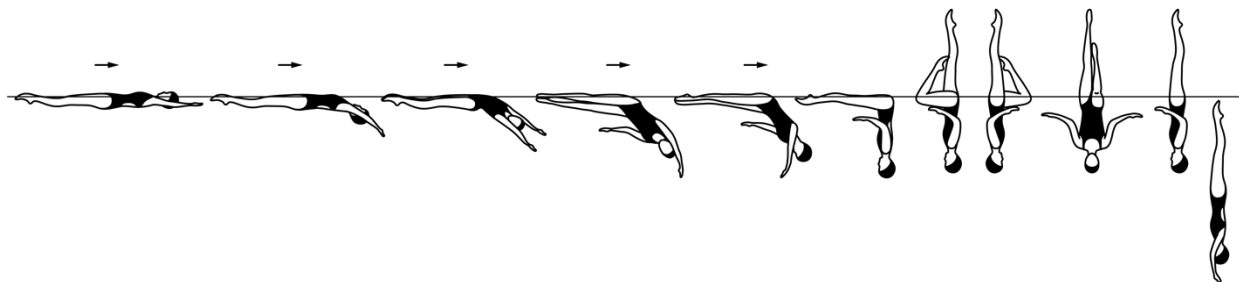


Figure – 240b ALBATROSS FULL TWIST

DIFFICULTY – 2.3

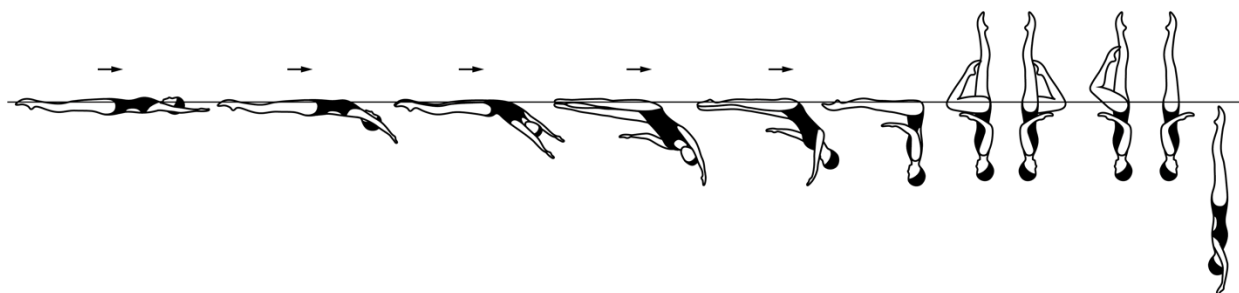


Figure – 240c ALBATROSS TWIRL

DIFFICULTY – 2.3

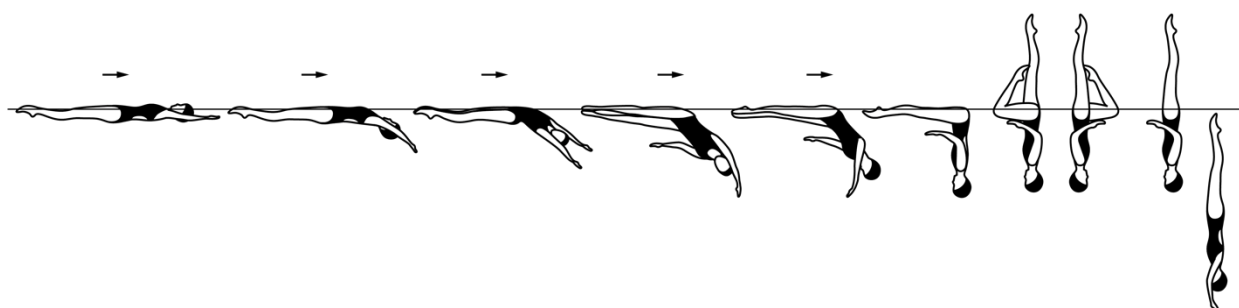


Figure – 240d ALBATROSS SPINNING 180°

DIFFICULTY – 1.9

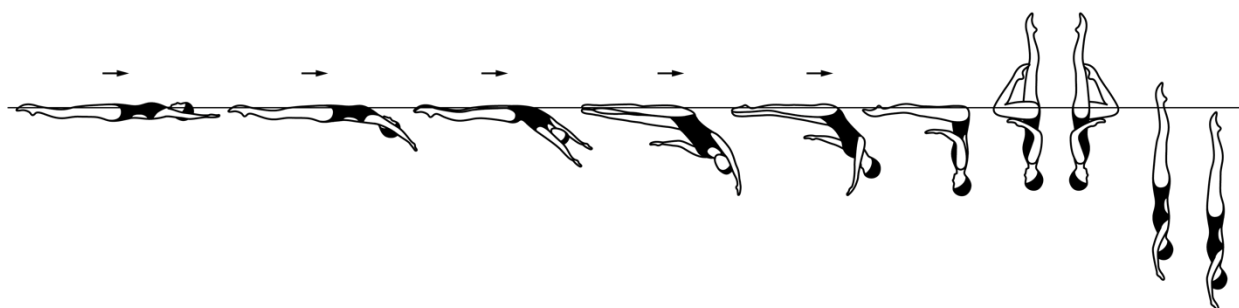


Figure – 240e ALBATROSS SPINNING 360°

DIFFICULTY – 2.0

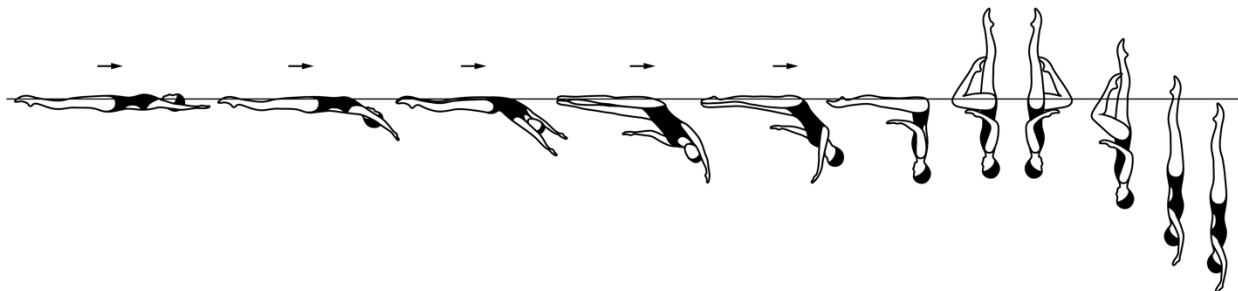


Figure – 240h ALBATROSS SPIN UP 180°

DIFFICULTY – 2.4

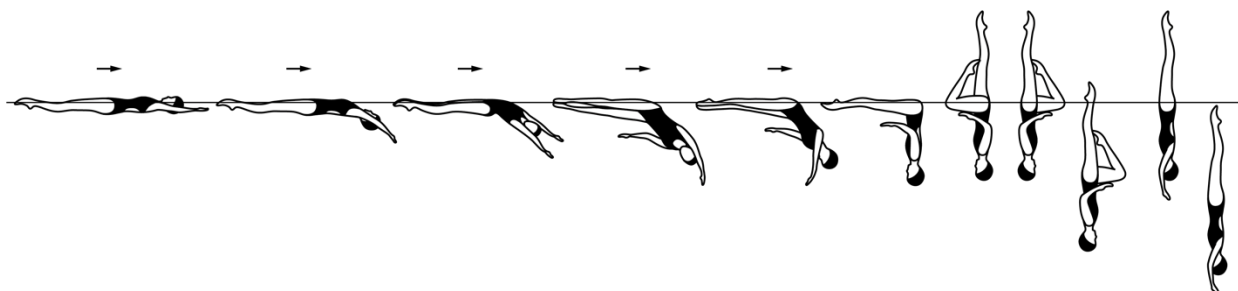


Figure – 240i ALBATROSS SPIN UP 360°

DIFFICULTY – 2.5

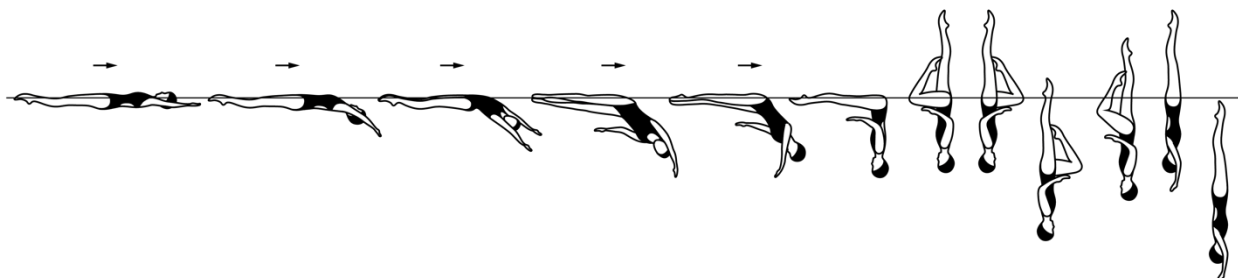


Figure – 240j ALBATROSS COMBINED SPIN (360°+360°)

DIFFICULTY – 2.6

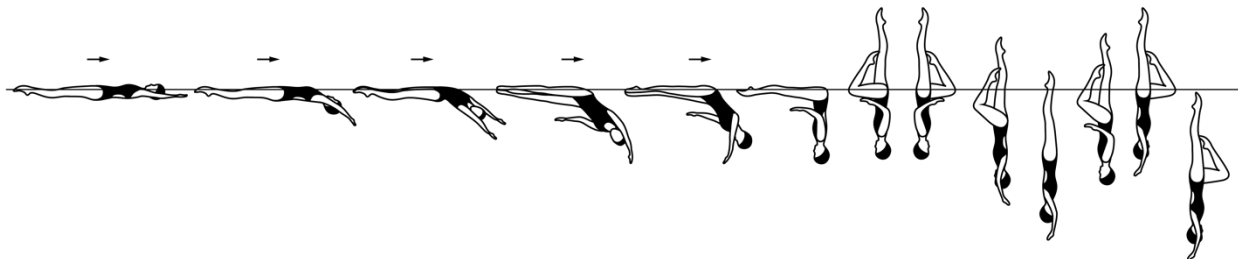
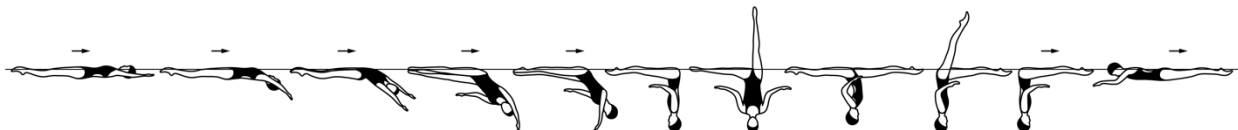


Figure - 241 GOELAND

DIFFICULTY – 2.0



CATEGORY III

Figure - 301 BARRACUDA

DIFFICULTY – 1.8

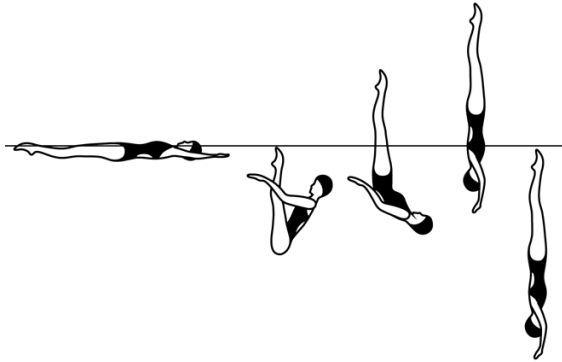


Figure – 301c BARRACUDA TWIRL
See 112c IBIS for TWIRL

DIFFICULTY – 2.5

Figure – 301d BARRACUDA SPINNING 180°
See 112d IBIS for SPINNING 180°

DIFFICULTY – 2.0

Figure – 301e BARRACUDA SPINNING 360°
See 112e IBIS for SPINNING 360°

DIFFICULTY – 2.3

Figure – 301f BARRACUDA CONTINUOUS SPIN (720°)
See 112f IBIS for CONTINUOUS SPIN (720°)

DIFFICULTY – 2.8

Figure – 301h BARRACUDA SPIN UP 180°
See 112h IBIS for SPIN UP 180°

DIFFICULTY – 2.4

Figure – 301i BARRACUDA SPIN UP 360°
See 112i IBIS for SPIN UP 360°

DIFFICULTY – 2.4

Figure - 302 BLOSSOM

DIFFICULTY – 1.4

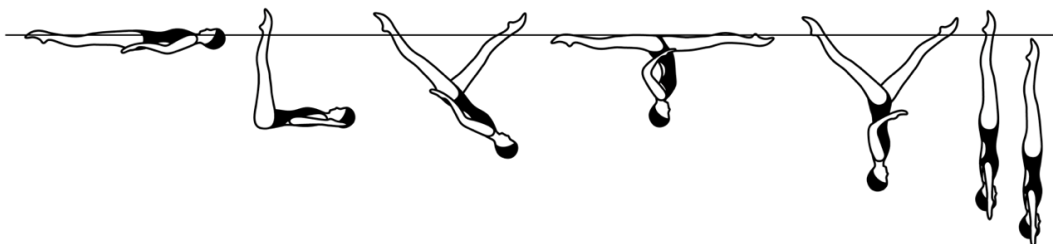


Figure - 303 SOMERSAULT BACK PIKE

DIFFICULTY – 1.4

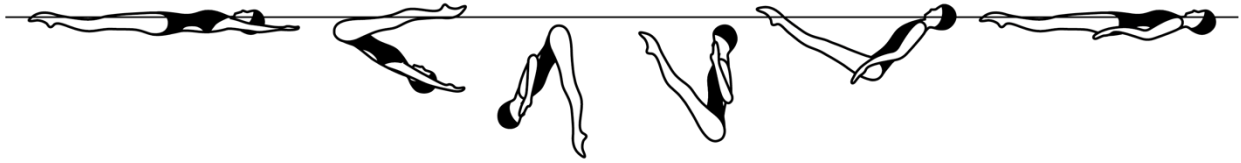


Figure - 306 BARRACUDA BENT KNEE

DIFFICULTY – 1.7

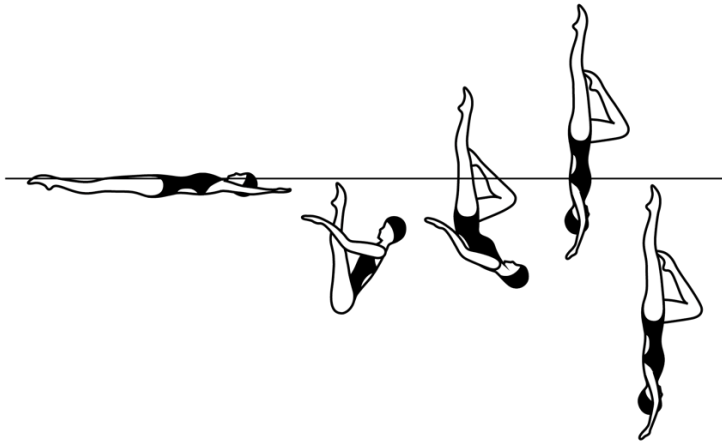


Figure – 306d BARRACUDA BENT KNEE SPINNING 180°

DIFFICULTY – 1.8

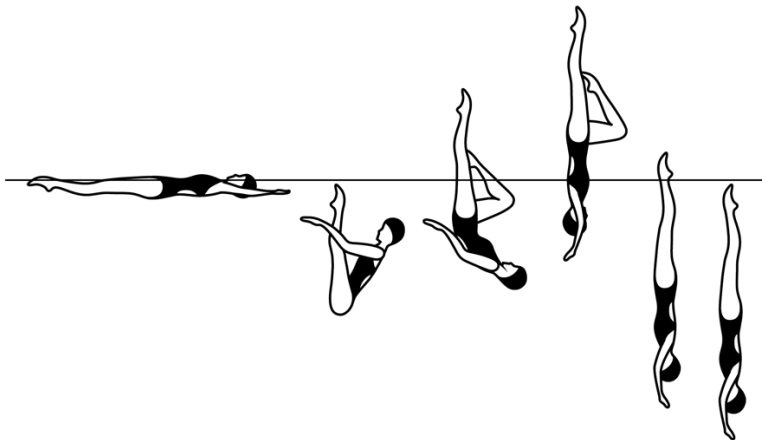


Figure – 306e BARRACUDA BENT KNEE SPINNING 360°

DIFFICULTY – 1.9

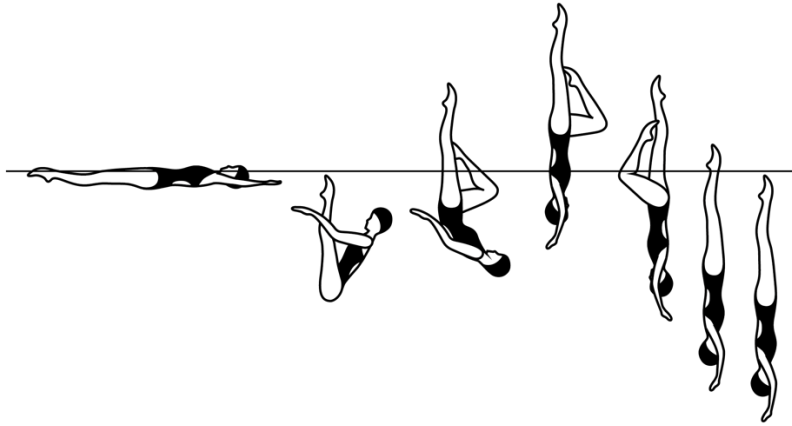


Figure - 307 FLYING FISH

DIFFICULTY – 2.4

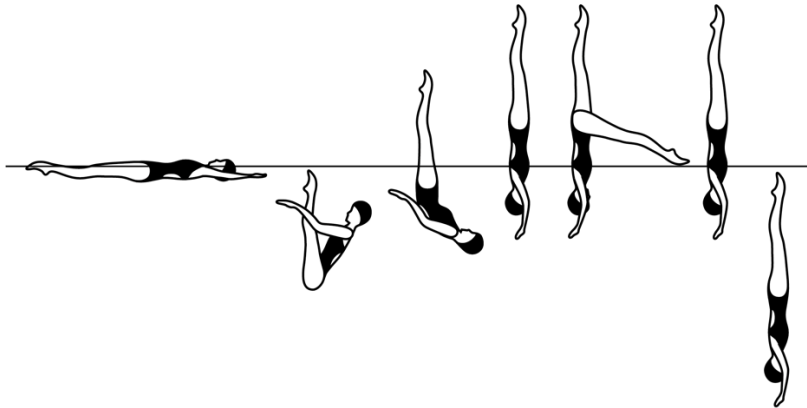


Figure – 307d FLYING FISH SPINNING 180°
See 112d IBIS for SPINNING 180°

DIFFICULTY – 2.6

Figure – 307e FLYING FISH SPINNING 360°
See 112e IBIS for SPINNING 360°

DIFFICULTY – 2.9

Figure - 308 BARRACUDA AIRBORNE SPLIT

DIFFICULTY – 2.3

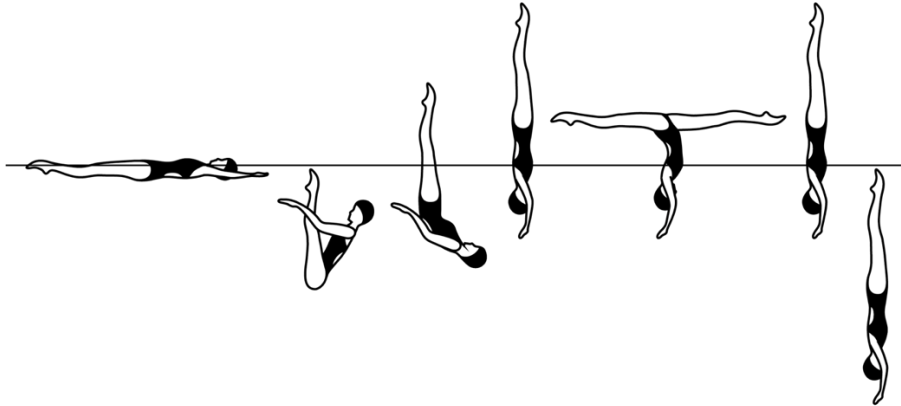


Figure – 308h BARRACUDA AIRBORNE SPLIT SPIN UP 180°

DIFFICULTY – 2.9

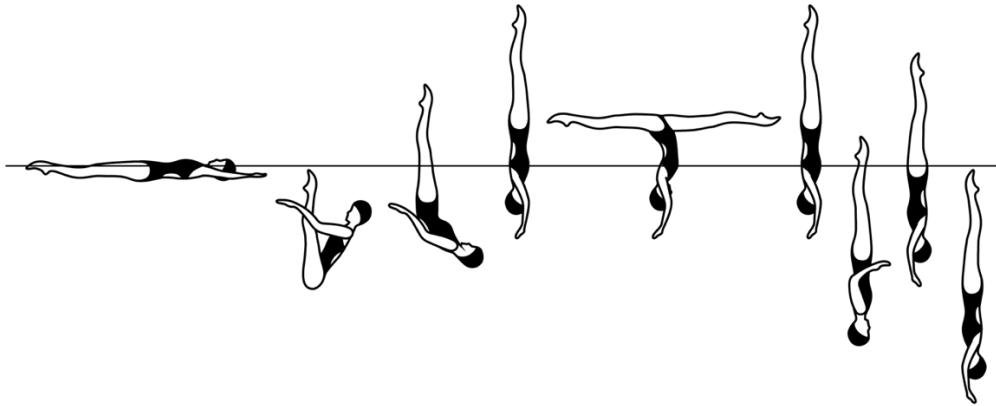


Figure – 308i BARRACUDA AIRBORNE SPLIT SPIN UP 360°

DIFFICULTY – 3.0

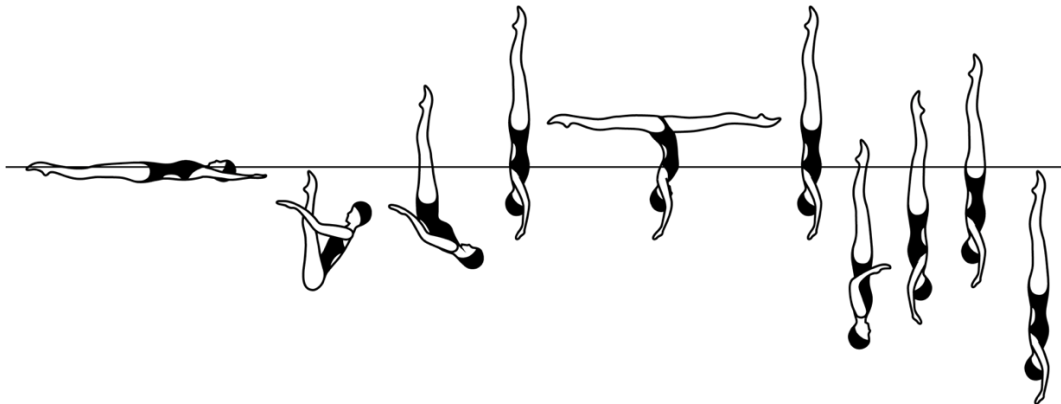


Figure - 310 SOMERSAULT BACK TUCK DIFFICULTY – 1.1

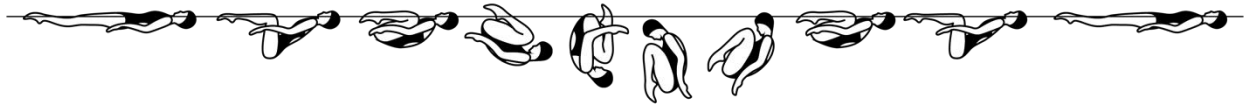


Figure – 311 KIP DIFFICULTY – 1.6

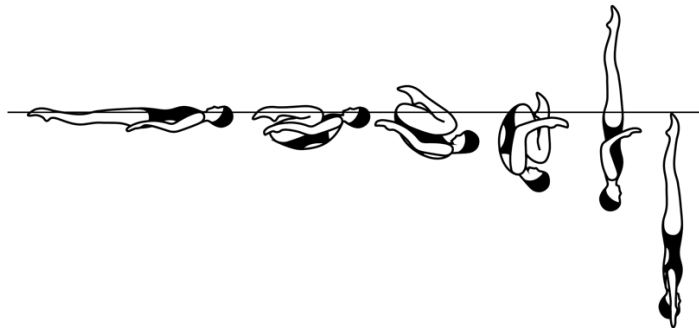


Figure – 311a KIP 1/2 TWIST DIFFICULTY – 2.0
See 112a IBIS for 1/2 TWIST

Figure – 311b KIP FULL TWIST DIFFICULTY – 2.2
See 112b IBIS for FULL TWIST

Figure – 311c KIP TWIRL DIFFICULTY – 2.1
See 112c IBIS for TWIRL

Figure – 311d KIP SPINNING 180° DIFFICULTY – 1.7
See 112d IBIS for SPINNING 180°

Figure – 311e KIP SPINNING 360° DIFFICULTY – 1.7
See 112e IBIS for SPINNING 360°

Figure – 311f KIP CONTINUOUS SPIN (720°) DIFFICULTY – 2.0
See 112f IBIS for CONTINUOUS SPIN (720°)

Figure – 311g KIP TWIST SPIN DIFFICULTY – 2.2
See 112g IBIS for TWIST SPIN

Figure – 311h KIP SPIN UP 180° DIFFICULTY – 2.2
See 112h IBIS for SPIN UP 180°

Figure – 311i KIP SPIN UP 360° DIFFICULTY – 2.3
See 112i IBIS for SPIN UP 360°

Figure – 311j KIP COMBINED SPIN (360°+360°)

DIFFICULTY – 2.4

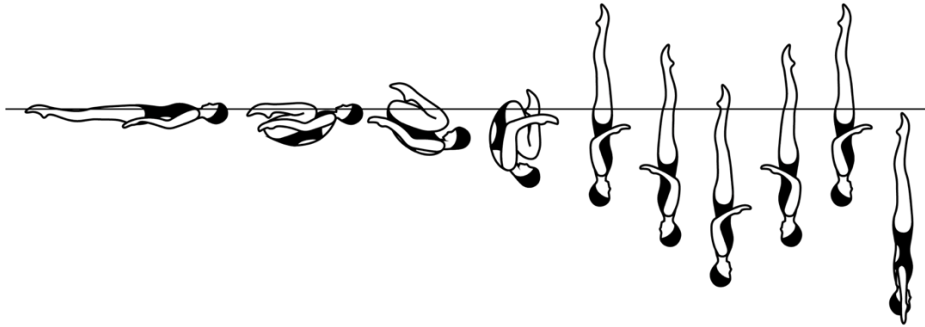


Figure – 312 KIP SPLIT

DIFFICULTY – 2.3

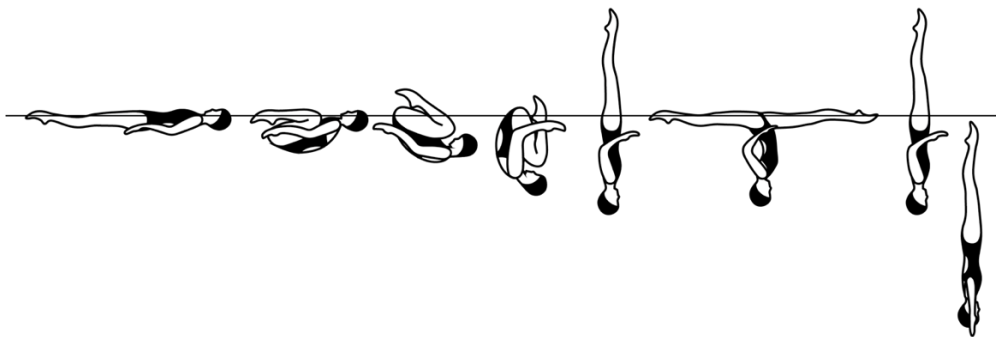


Figure – 313 KIP SPLIT CLOSING 180°

DIFFICULTY – 2.2

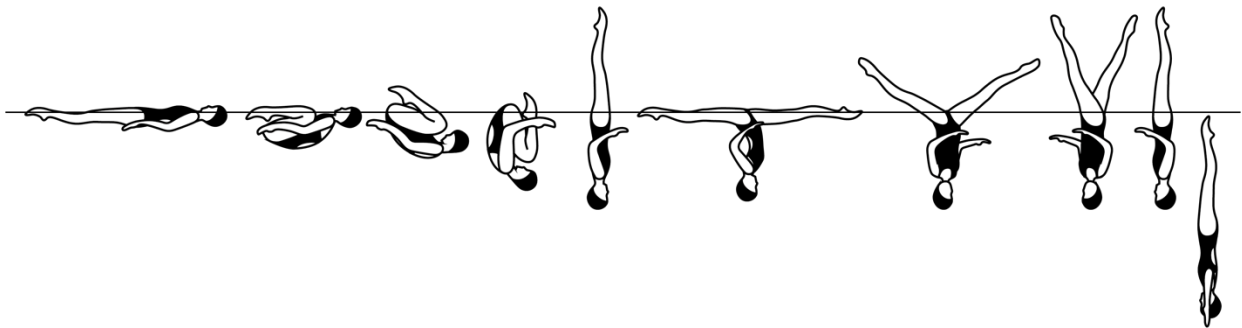


Figure – 314 KIP SPLIT OPEN 360°

DIFFICULTY – 2.9

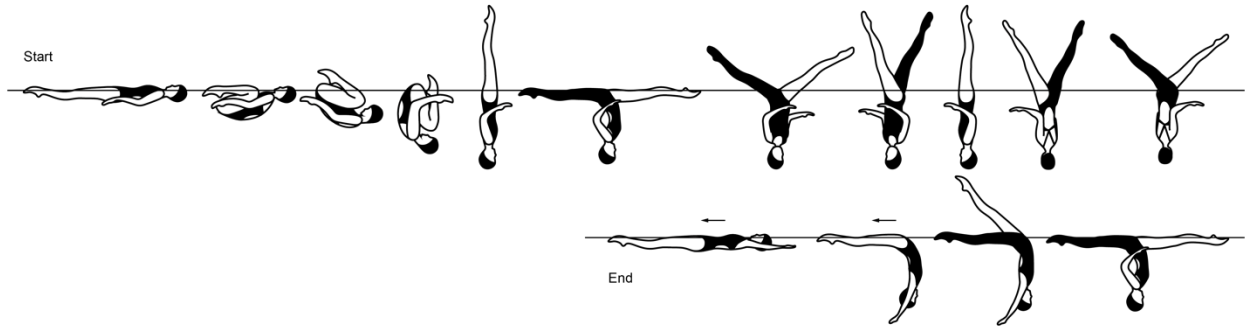


Figure – 315 SEAGULL

DIFFICULTY – 2.2

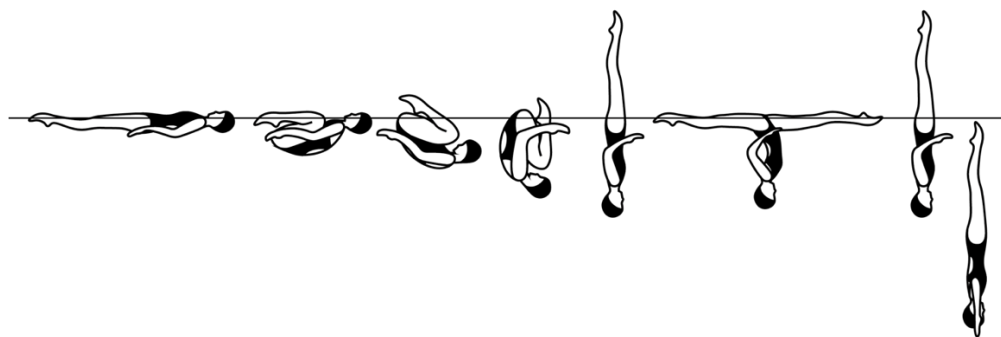


Figure – 315c SEAGULL TWIRL
See 112c IBIS for TWIRL

DIFFICULTY – 2.7

Figure – 315d SEAGULL SPINNING 180°
See 112d IBIS for SPINNING 180°

DIFFICULTY – 2.2

Figure – 315e SEAGULL SPINNING 360°

DIFFICULTY – 2.3

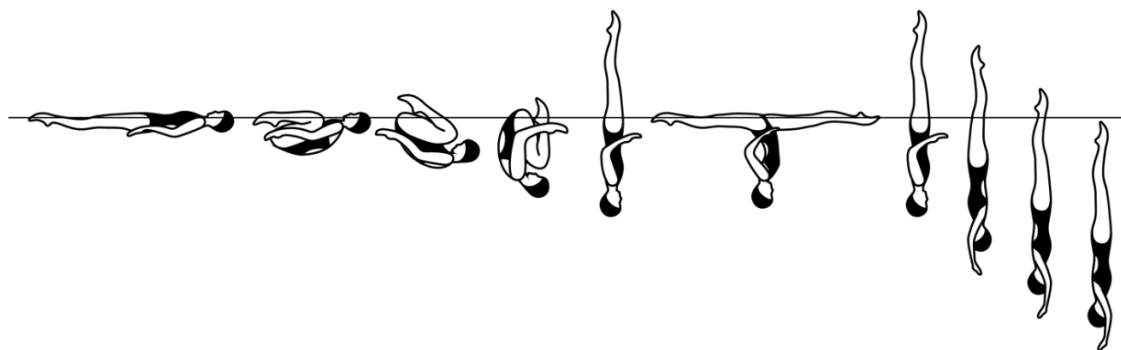


Figure – 315f SEAGULL CONTINUOUS SPIN (720°)
See 112f IBIS for CONTINUOUS SPIN (720°)

DIFFICULTY – 2.6

Figure – 315h SEAGULL SPIN UP 180°
See 112h IBIS for SPIN UP 180°

DIFFICULTY – 2.8

Figure – 315i SEAGULL SPIN UP 360°
See 112i IBIS for SPIN UP 360°

DIFFICULTY – 2.8

Figure – 316 KIPNUS

DIFFICULTY – 1.4

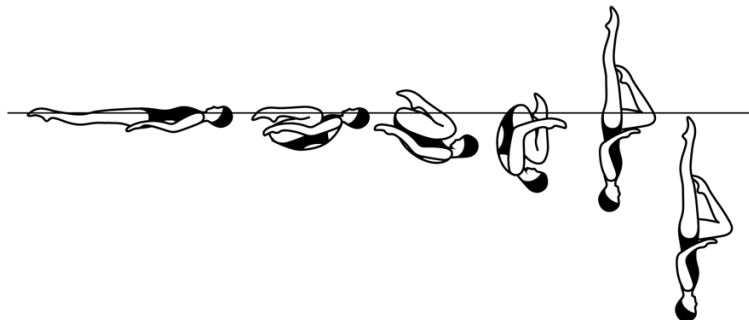


Figure – 317 KIPNUS VARIANT

DIFFICULTY – 1.9

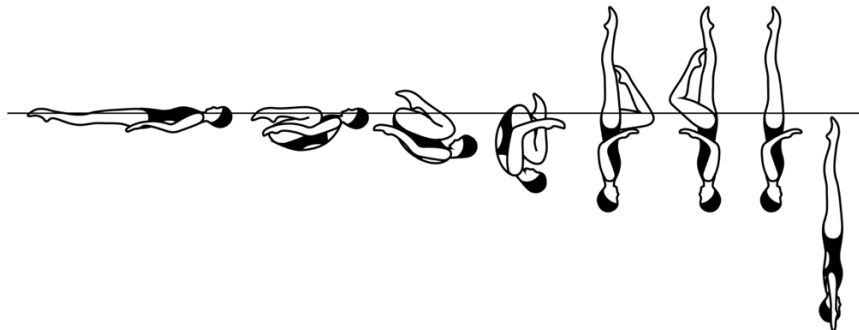


Figure – 318 KIP BENT KNEE

DIFFICULTY – 1.8

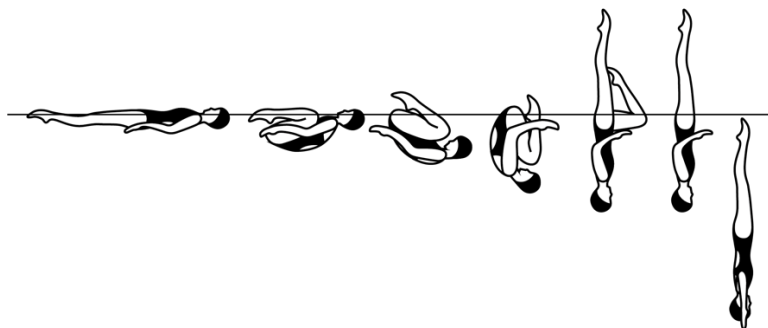


Figure – 319 KIPSWIRL

DIFFICULTY – 1.7

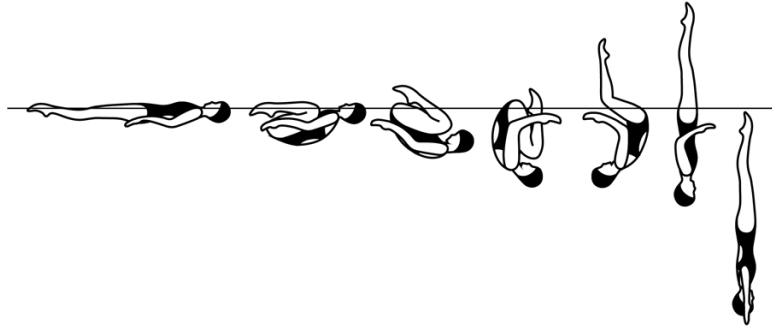


Figure – 319c KIPSWIRL TWIRL
See 112c IBIS for TWIRL

DIFFICULTY – 2.1

Figure – 319d KIPSWIRL SPINNING 180°
See 112d IBIS for SPINNING 180°

DIFFICULTY – 1.7

Figure – 319e KIPSWIRL SPINNING 360°
See 112e IBIS for SPINNING 360°

DIFFICULTY – 1.8

Figure – 319f KIPSWIRL CONTINUOUS SPIN (720°)
See 112f IBIS for CONTINUOUS SPIN (720°)

DIFFICULTY – 2.0

Figure – 320 KIPSWIRL SPLIT CLOSING 180°

DIFFICULTY – 2.3

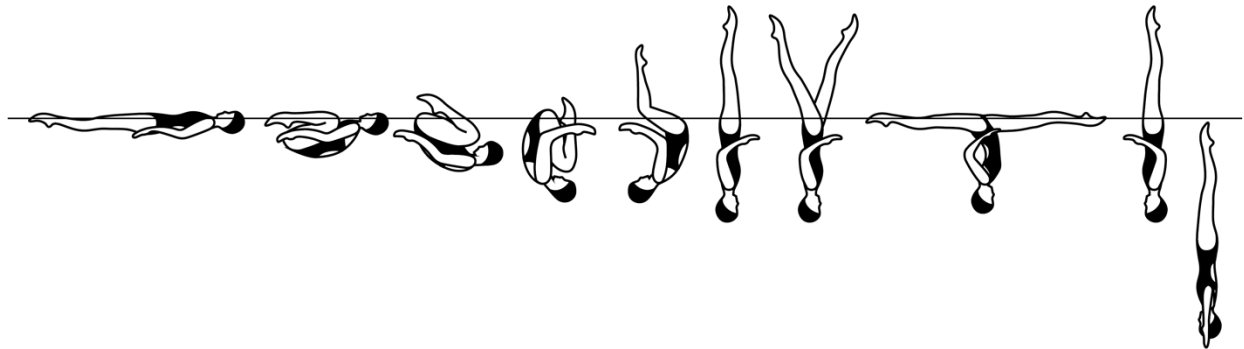


Figure – 321 KIPSWIRL SPLIT CLOSING 360°

DIFFICULTY – 2.5

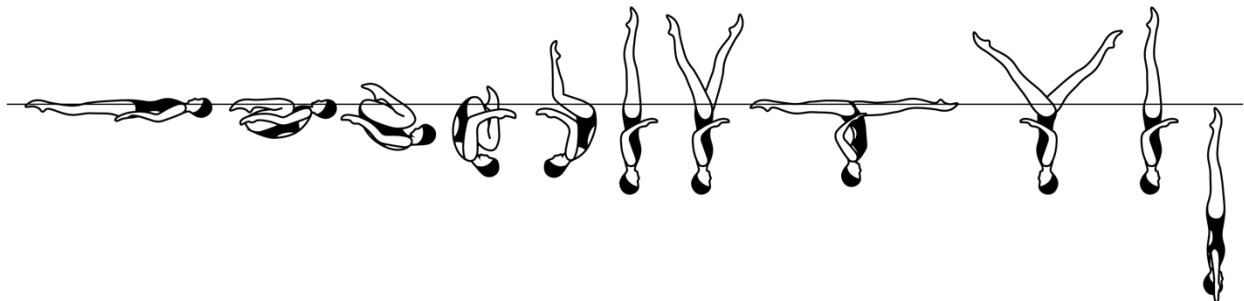


Figure – 322 ELEVATOR

DIFFICULTY – 2.5

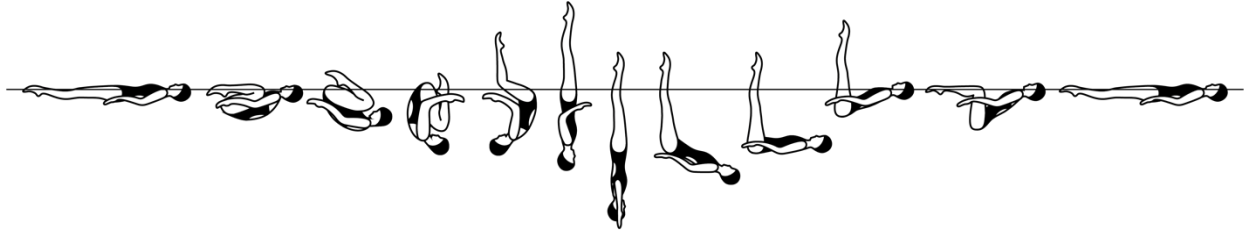


Figure - 323 **SOMERSAULT FRONT PIKE** **DIFFICULTY – 1.4**

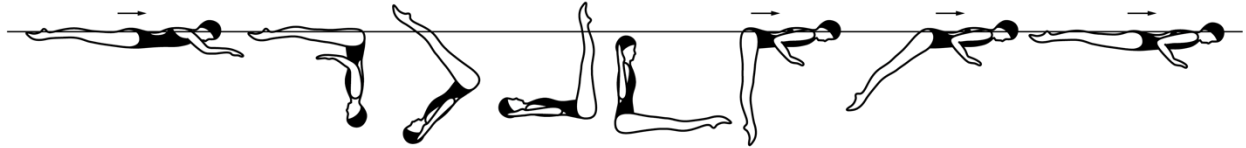


Figure - 324 **SOMERSUB** **DIFFICULTY – 1.9**

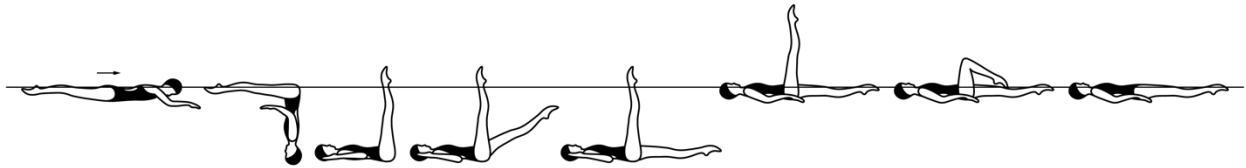


Figure - 325 **SUBALINA** **DIFFICULTY – 2.2**

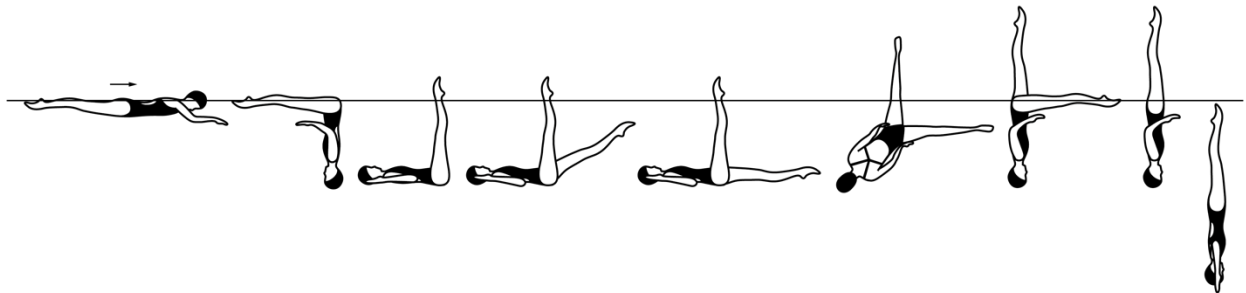


Figure - 326 SUBILARC DIFFICULTY – 2.8

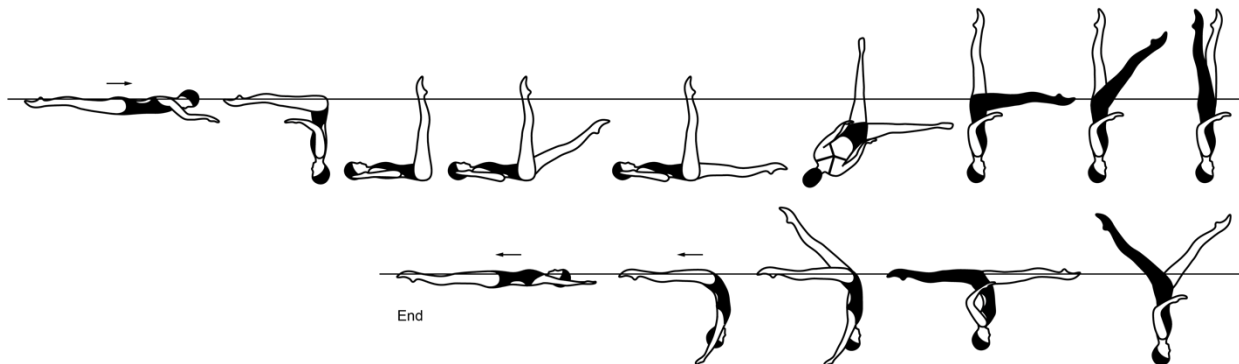


Figure - 327 BALLERINA DIFFICULTY – 1.8

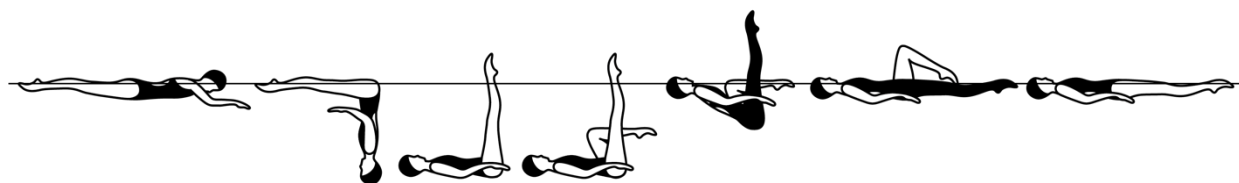


Figure - 328 LAGOON DIFFICULTY – 2.4

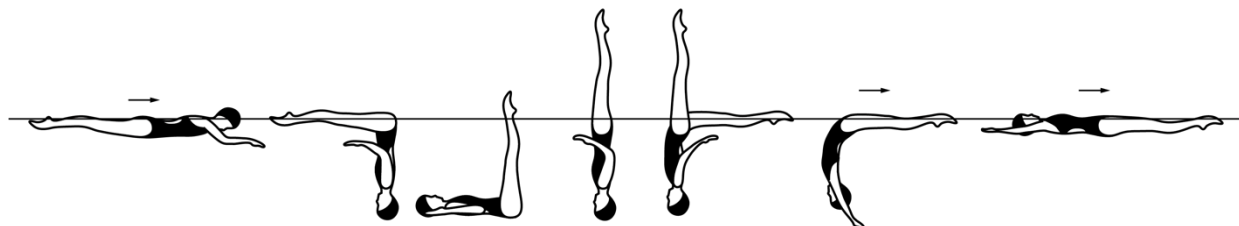


Figure - 330 AURORA DIFFICULTY – 2.3

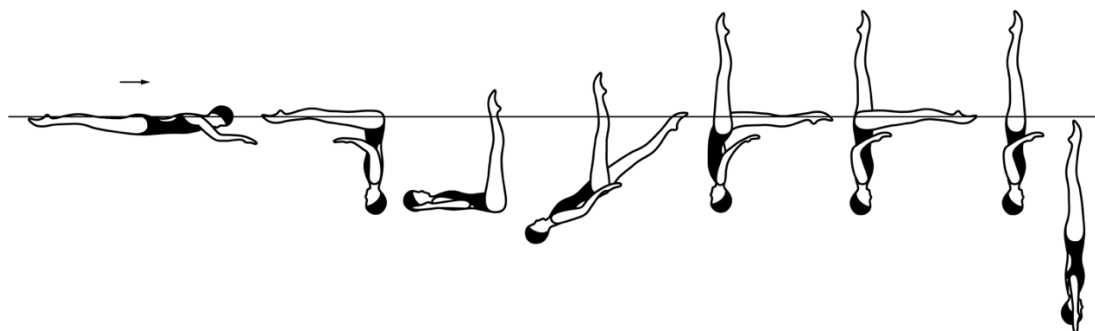


Figure – 330a AURORA 1/2 TWIST DIFFICULTY – 2.7
See 112a IBIS for 1/2 TWIST

Figure – 330c AURORA TWIRL DIFFICULTY – 2.8
See 112c IBIS for TWIRL

Figure – 330d AURORA SPINNING 180°
See 112d IBIS for SPINNING 180°

DIFFICULTY – 2.3

Figure – 330e AURORA SPINNING 360°
See 112e IBIS for SPINNING 360°

DIFFICULTY – 2.4

Figure – 330f AURORA CONTINUOUS SPIN (720°)
See 112f IBIS for CONTINUOUS SPIN (720°)

DIFFICULTY – 2.7

Figure – 330g AURORA TWIST SPIN
See 112g IBIS for TWIST SPIN

DIFFICULTY – 2.9

Figure - 331 AURORA OPEN 180°

DIFFICULTY – 3.0

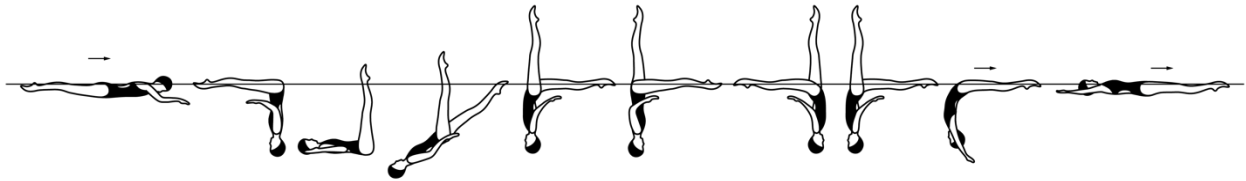


Figure - 332 AURORA OPEN 360°

DIFFICULTY – 3.1

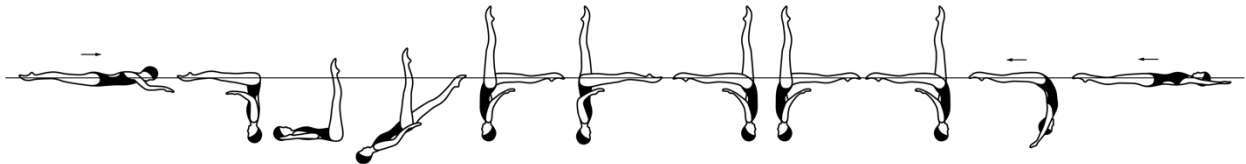


Figure - 335 GAVIATA

DIFFICULTY – 2.3

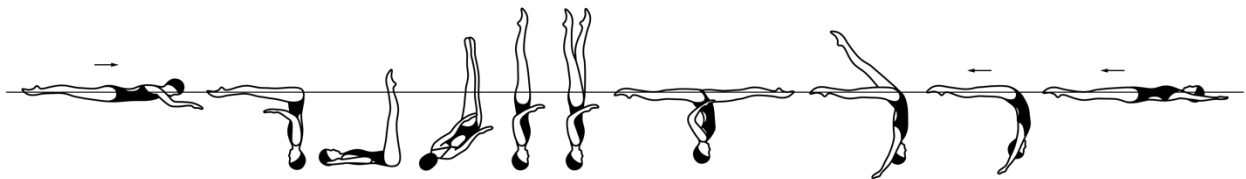


Figure - 336 GAVIATA OPEN 180°

DIFFICULTY – 2.4

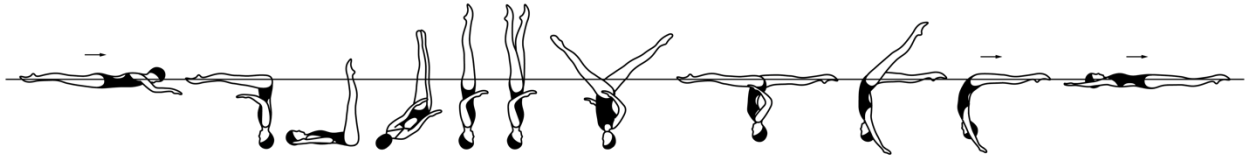


Figure - 342 HERON

DIFFICULTY - 1.9

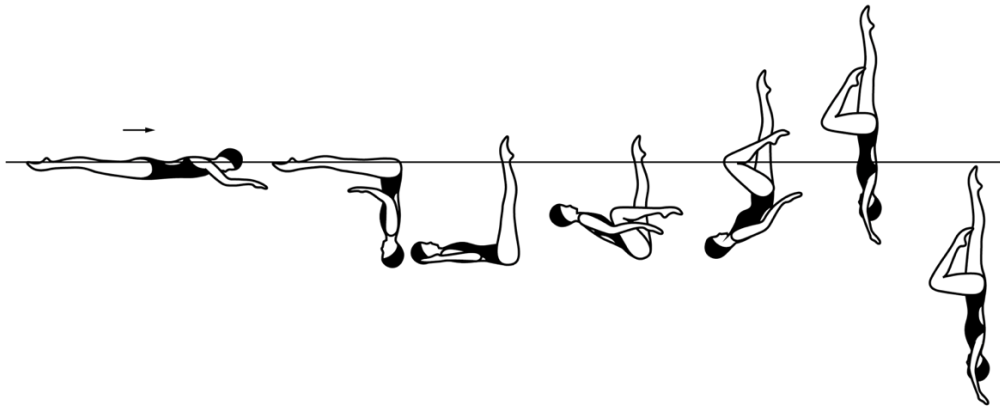


Figure - 342c HERON TWIRL

DIFFICULTY - 2.4

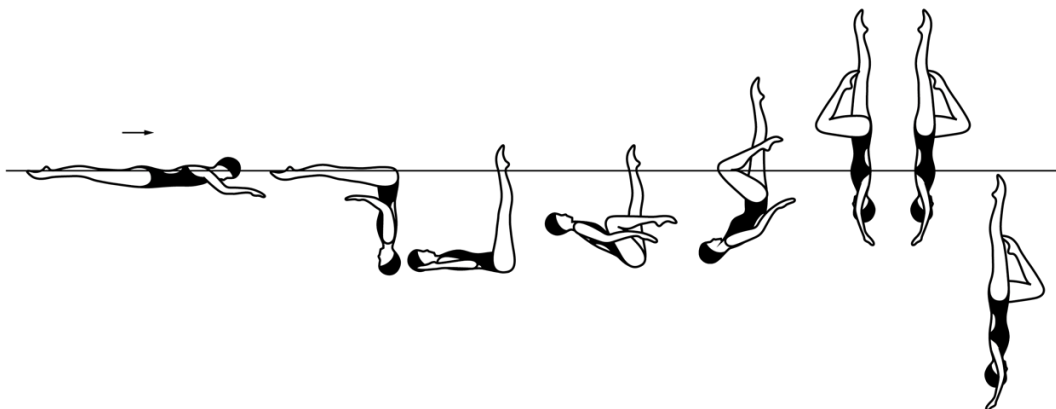


Figure - 342d HERON SPINNING 180°

DIFFICULTY - 2.1

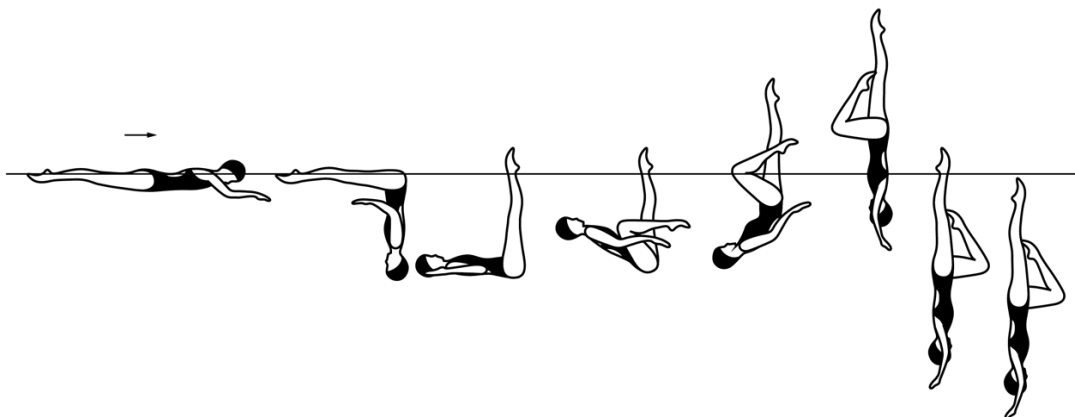


Figure – 342e HERON SPINNING 360°

DIFFICULTY – 2.2

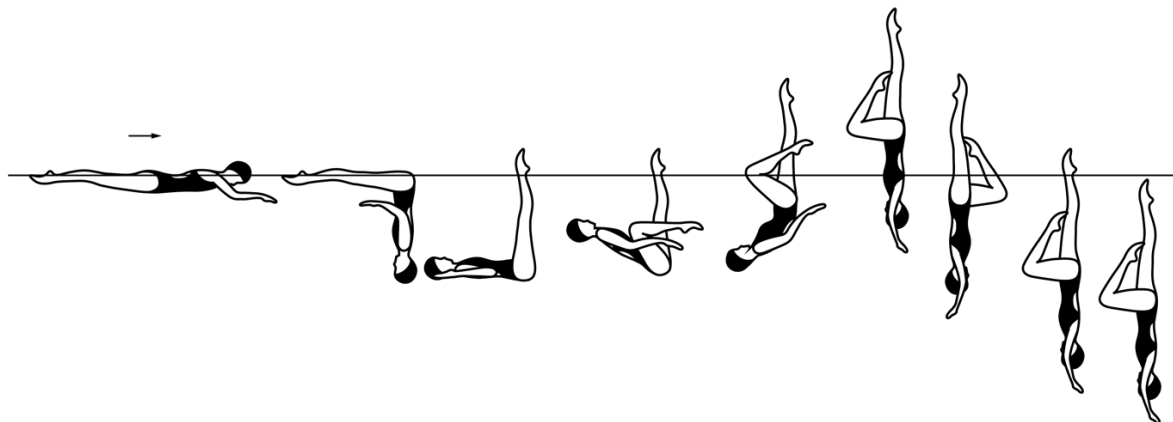


Figure – 342f HERON CONTINUOUS SPIN (720°)

DIFFICULTY – 2.4

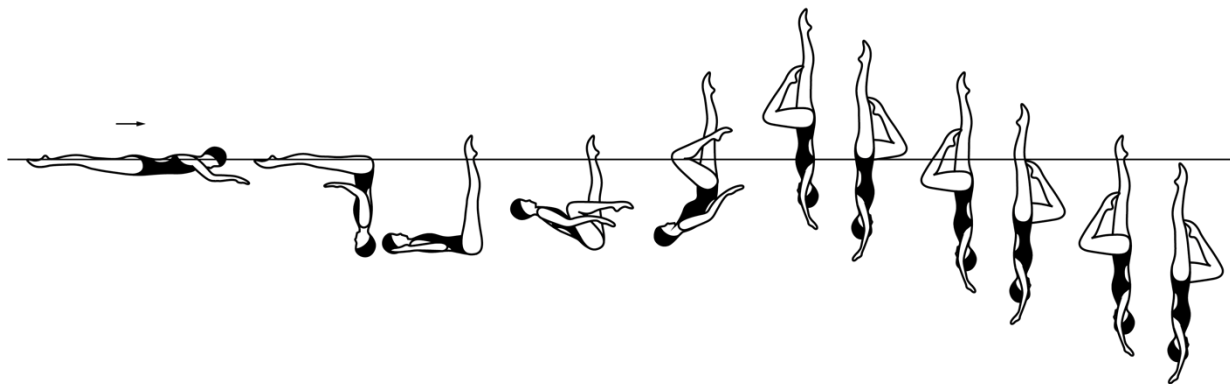


Figure – 342h HERON SPIN UP 180°

DIFFICULTY – 2.4

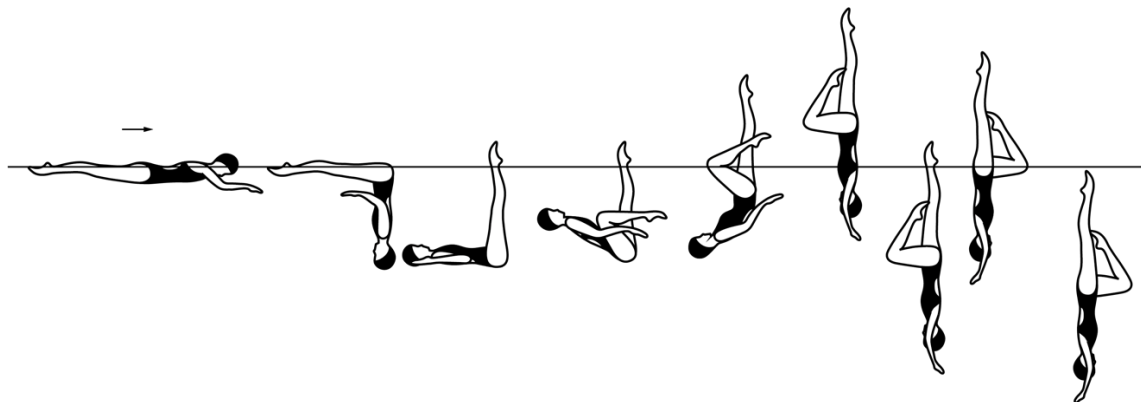


Figure – 342i HERON SPIN UP 360°

DIFFICULTY – 2.4

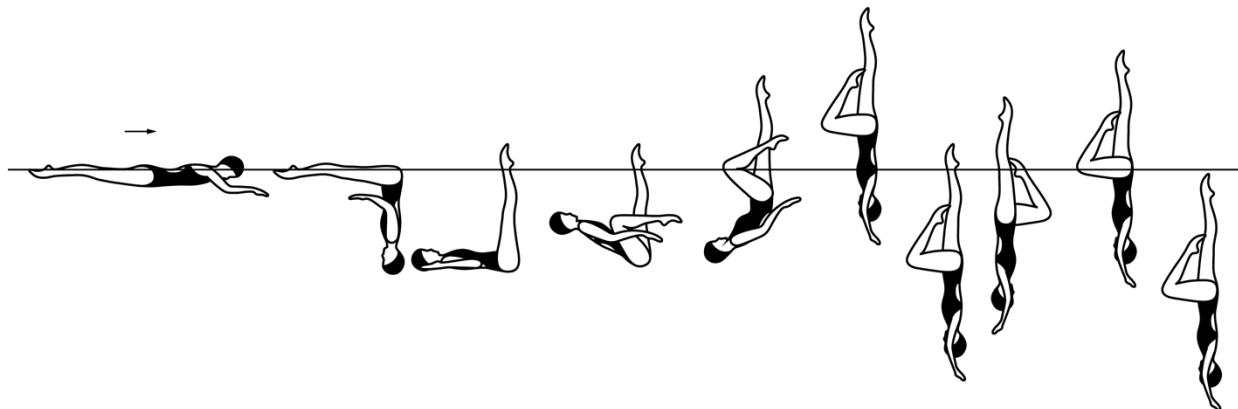


Figure - 343 BUTTERFLY

DIFFICULTY – 2.5

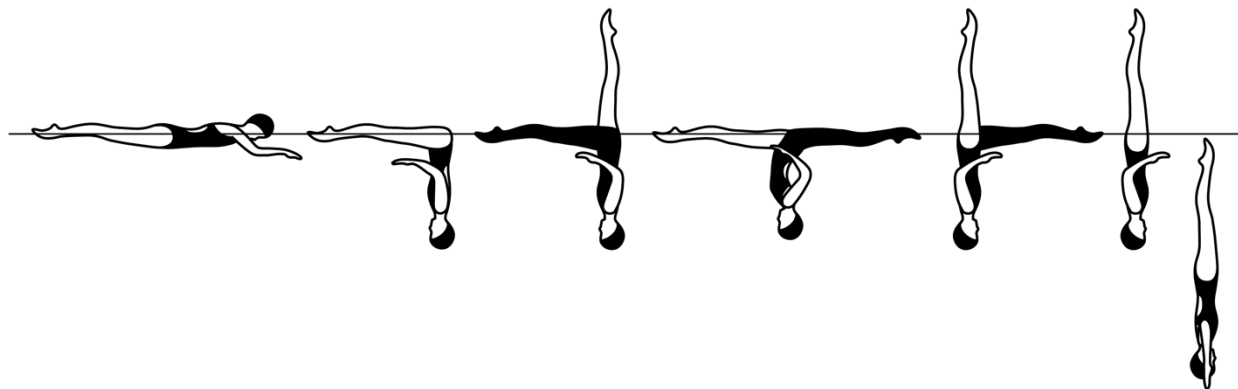


Figure - 344 NEPTUNUS

DIFFICULTY – 1.6

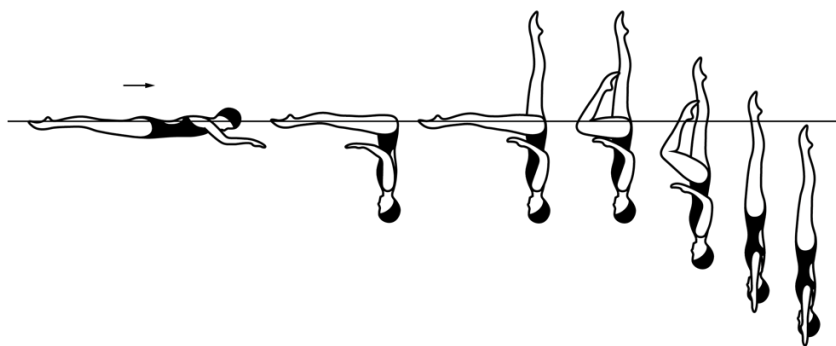


Figure - 345 CATALINA REVERSE

DIFFICULTY – 2.1

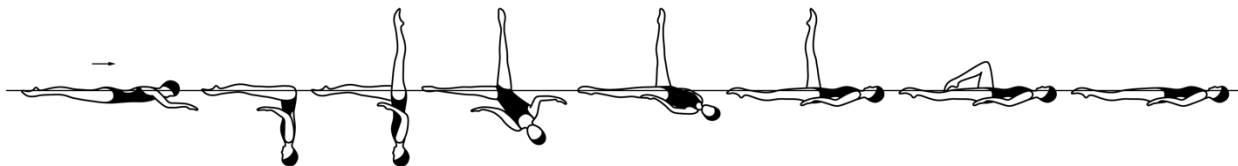


Figure - 346 SIDE FISHTAIL SPLIT

DIFFICULTY – 2.0

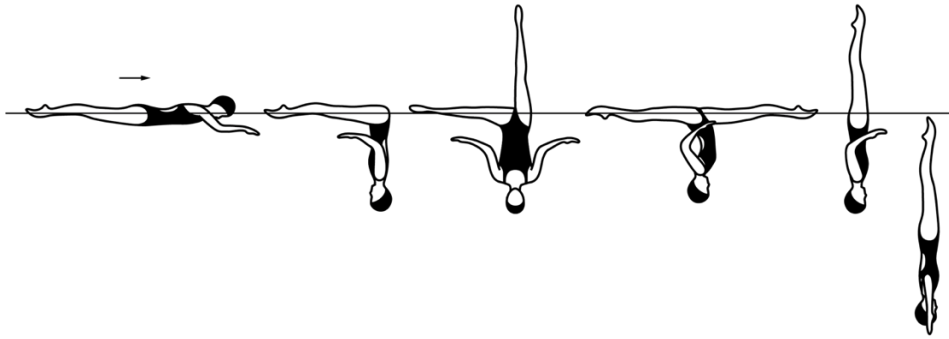


Figure - 347 MINERVA

DIFFICULTY – 2.0

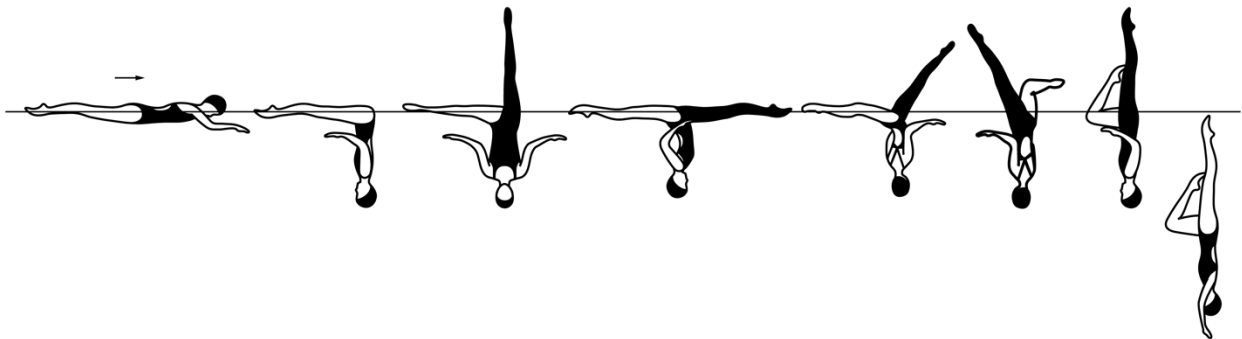


Figure - 348 TOWER

DIFFICULTY – 1.9

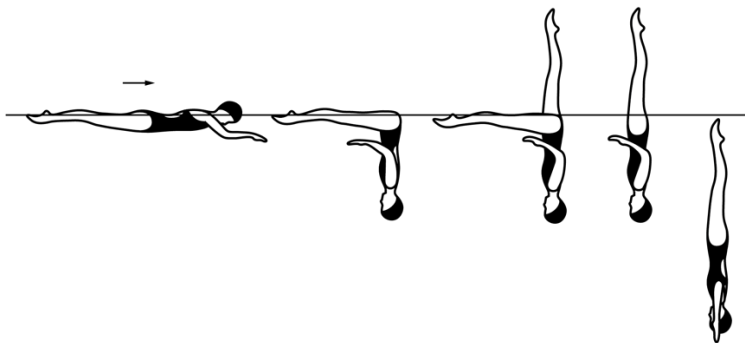


Figure - 349 BELUGA

DIFFICULTY – 2.1

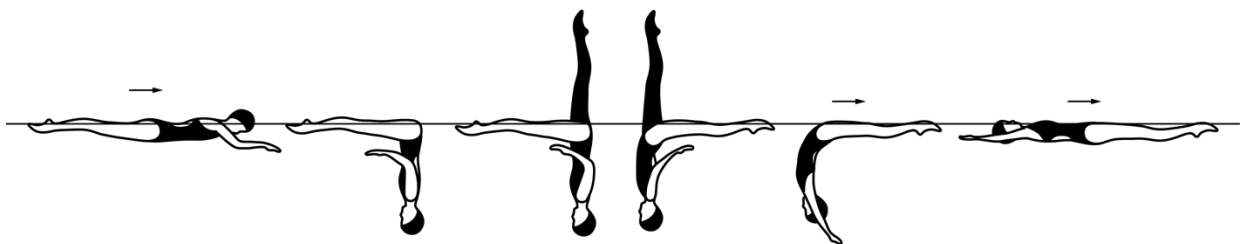


Figure - 350 DALECARLIA

DIFFICULTY - 2.6

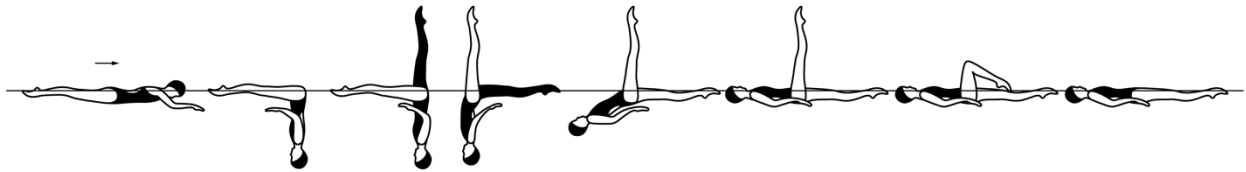


Figure - 351 JUPITER

DIFFICULTY - 2.8

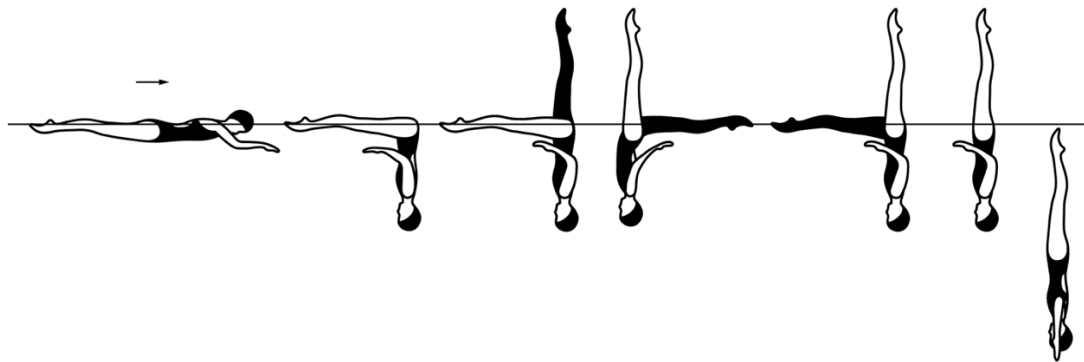


Figure - 352 VENUS

DIFFICULTY - 3.0

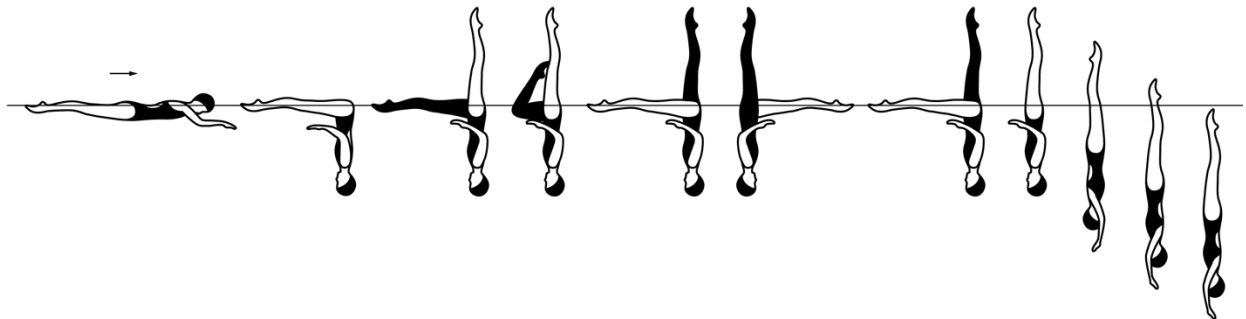


Figure - 355 PORPOISE

DIFFICULTY - 1.8

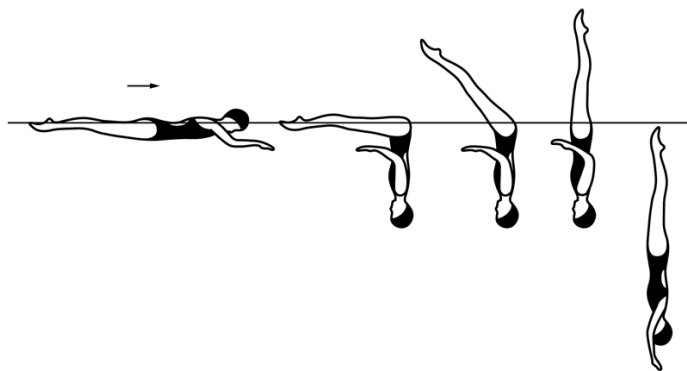


Figure – 355a PORPOISE 1/2 TWIST DIFFICULTY – 2.2
See 112a IBIS for 1/2 TWIST

Figure – 355b PORPOISE FULL TWIST DIFFICULTY – 2.4
See 112b IBIS for FULL TWIST

Figure – 355c PORPOISE TWIRL DIFFICULTY – 2.3
See 112c IBIS for TWIRL

Figure – 355d PORPOISE SPINNING 180° DIFFICULTY – 1.9
See 112d IBIS for SPINNING 180°

Figure – 355e PORPOISE SPINNING 360° DIFFICULTY – 1.9
See 112e IBIS for SPINNING 360°

Figure – 355f PORPOISE CONTINUOUS SPIN (720°) DIFFICULTY – 2.2
See 112f IBIS for CONTINUOUS SPIN (720°)

Figure – 355g PORPOISE TWIST SPIN DIFFICULTY – 2.5
See 112g IBIS for TWIST SPIN

Figure – 355h PORPOISE SPIN UP 180° DIFFICULTY – 2.5
See 112h IBIS for SPIN UP 180°

Figure – 355i PORPOISE SPIN UP 360° DIFFICULTY – 2.5
See 112i IBIS for SPIN UP 360°

Figure – 355j PORPOISE COMBINED SPIN (360°+360°) DIFFICULTY – 2.6
See 112j IBIS for COMBINED SPIN (360°+360°)

Figure – 356 WHIP DIFFICULTY – 2.6

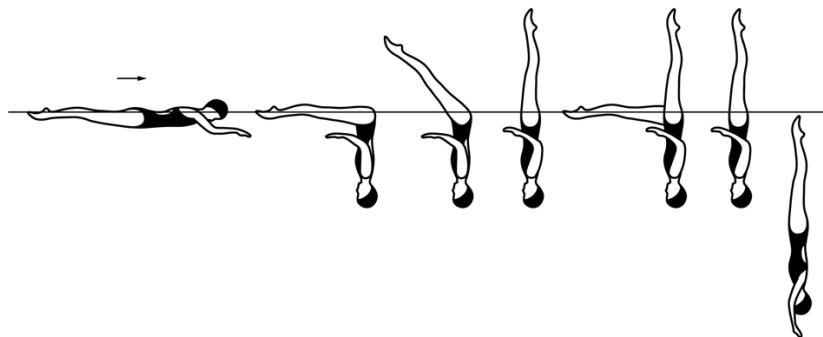


Figure – 356f WHIP CONTINUOUS SPIN (720°)

DIFFICULTY – 3.0

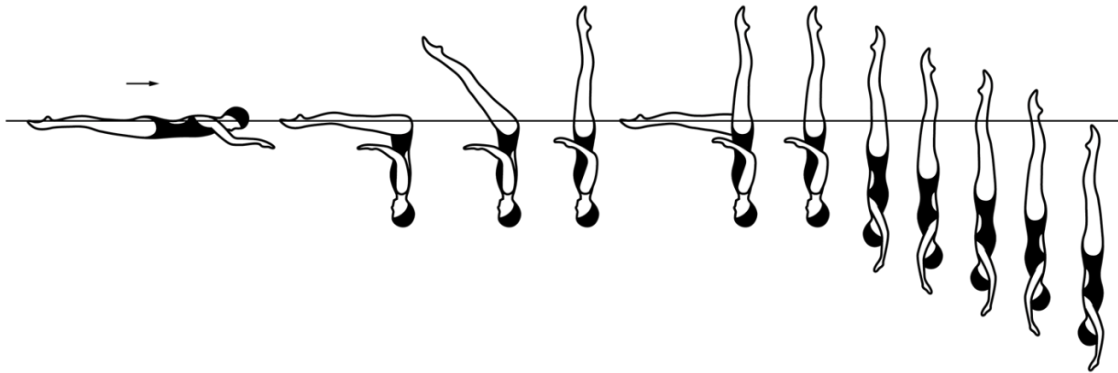


Figure – 359 FRONT ARIANA

DIFFICULTY – 2.2

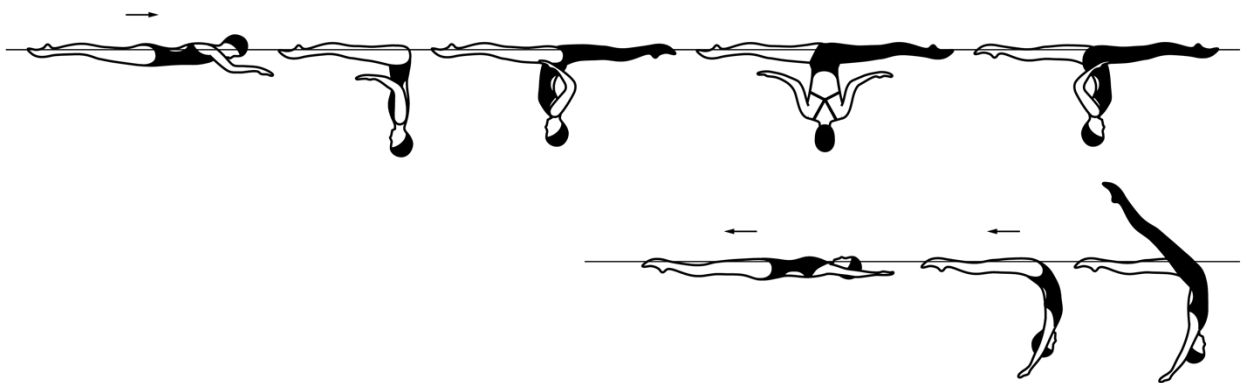


Figure – 360 WALKOVER FRONT

DIFFICULTY – 1.9

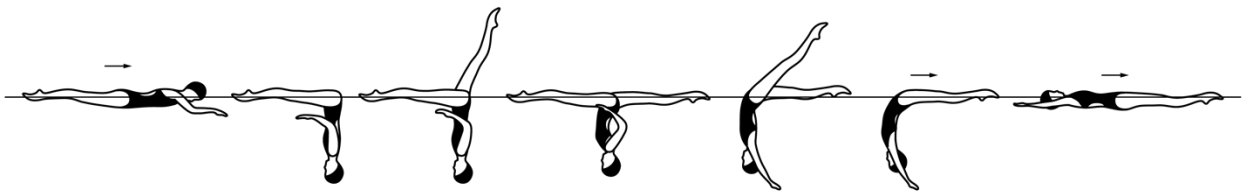


Figure – 361 PRAWN

DIFFICULTY – 1.5

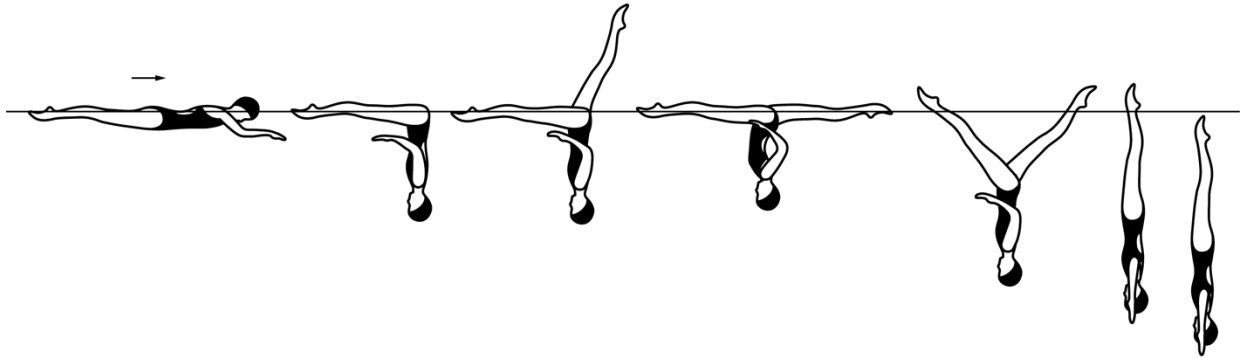


Figure – 362 SURFACE PRAWN

DIFFICULTY – 1.3

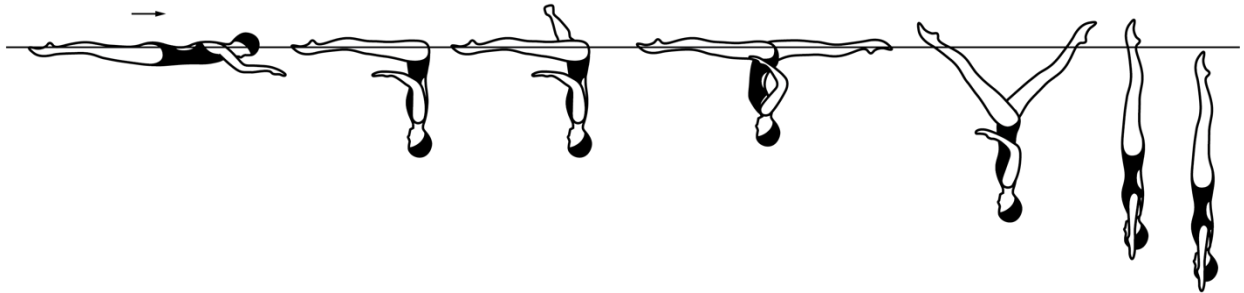


Figure – 363 WATER DROP

DIFFICULTY – 1.8

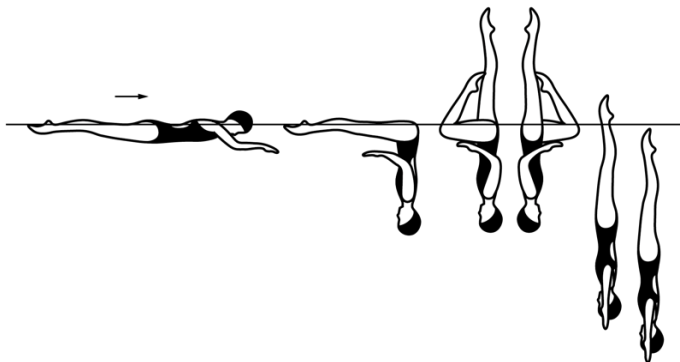
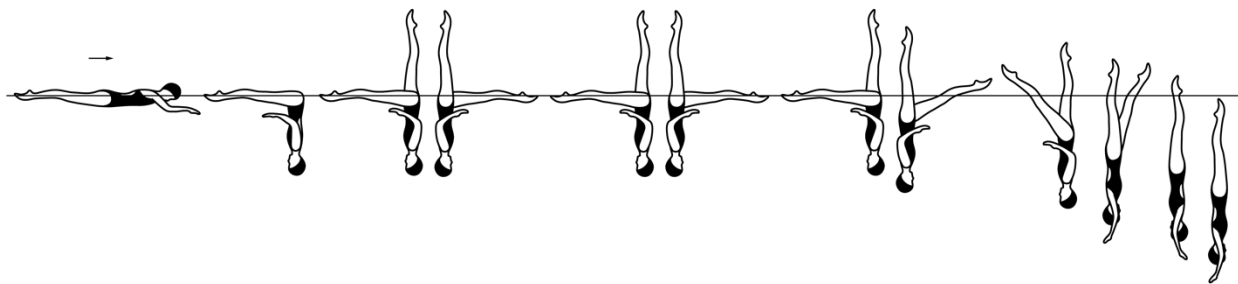


Figure – 364

WHIRLWIND

DIFFICULTY – 2.7



CATEGORY IV

Figure – 401 SWORDFISH

DIFFICULTY – 2.1

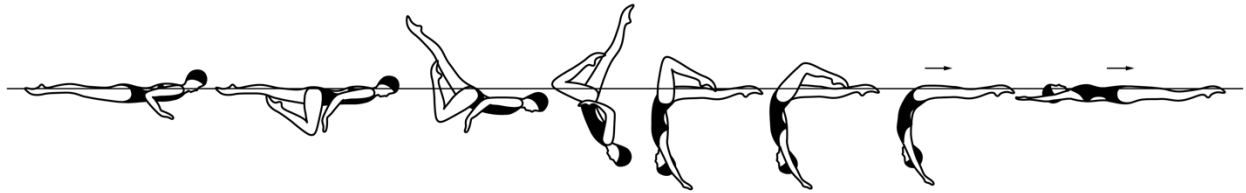


Figure – 402 SWORDASUB

DIFFICULTY – 2.3

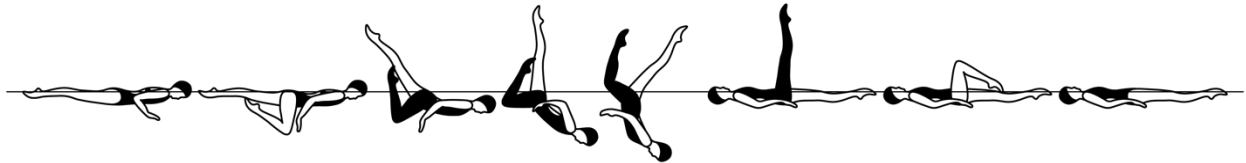


Figure – 403 SWORDTAIL

DIFFICULTY – 2.3

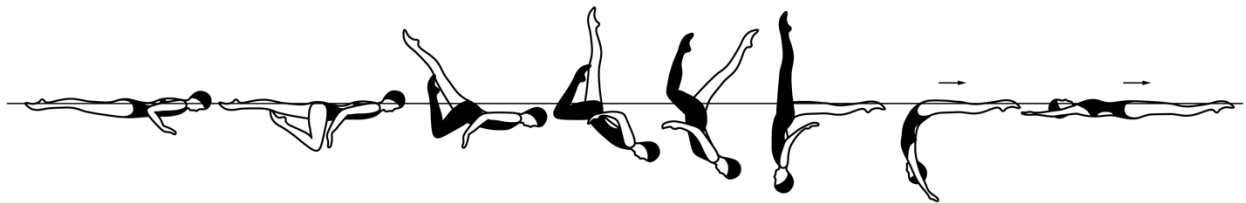


Figure – 405 SWORDALINA

DIFFICULTY – 2.5

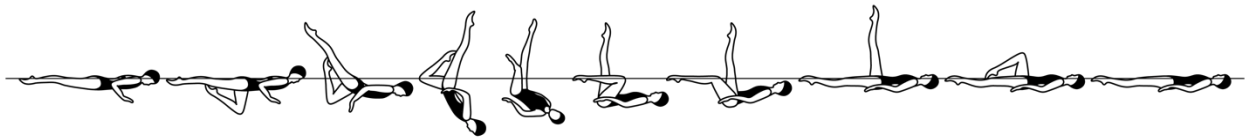


Figure – 406 SWORDFISH STRAIGHT LEG

DIFFICULTY – 2.3

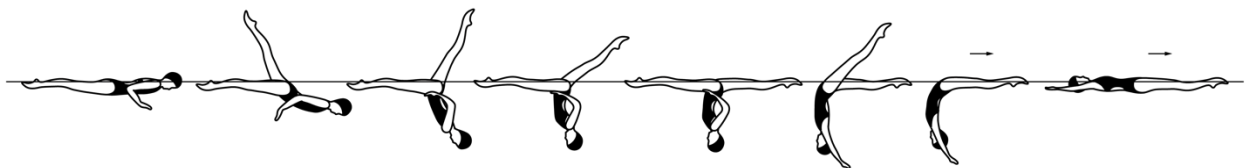


Figure – 407 SWORDFISH STRAIGHT LEG ARIANA ROTATION

DIFFICULTY – 2.6

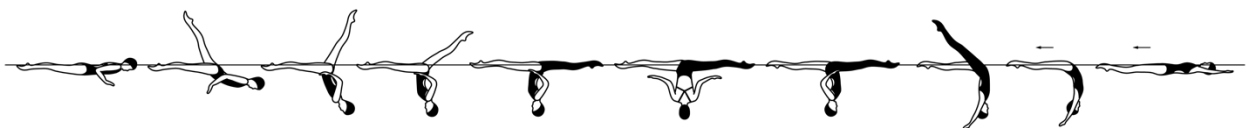


Figure – 410 HIGHTOWER

DIFFICULTY – 3.3

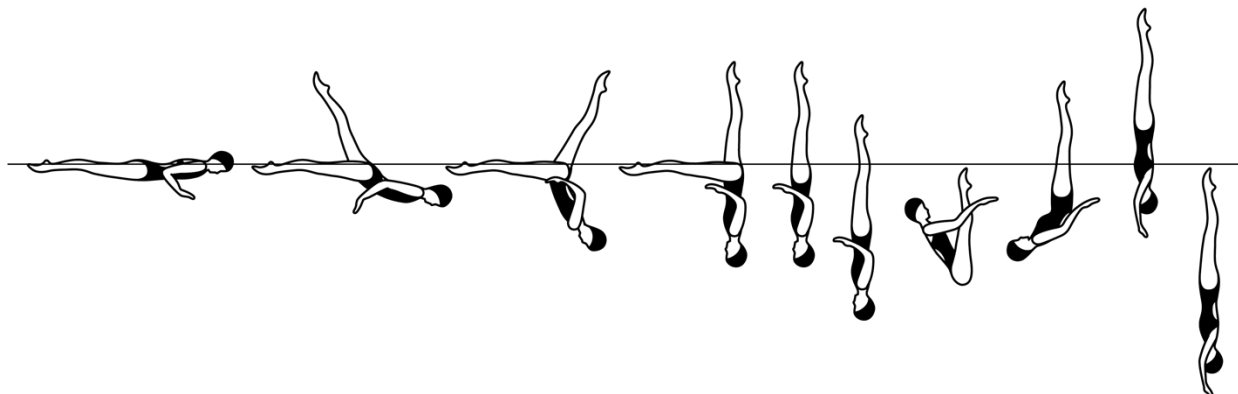


Figure – 413 ALBA

DIFFICULTY – 2.7

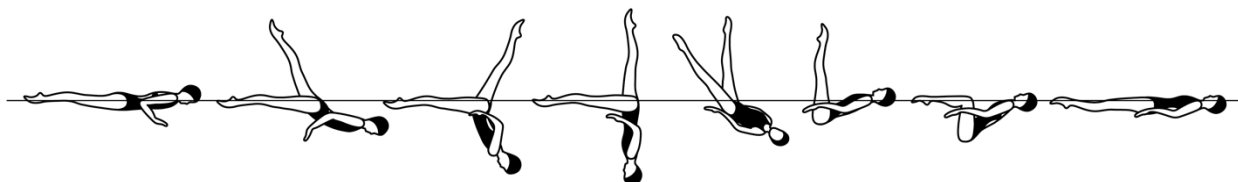


Figure – 420 WALKOVER BACK

DIFFICULTY – 2.1

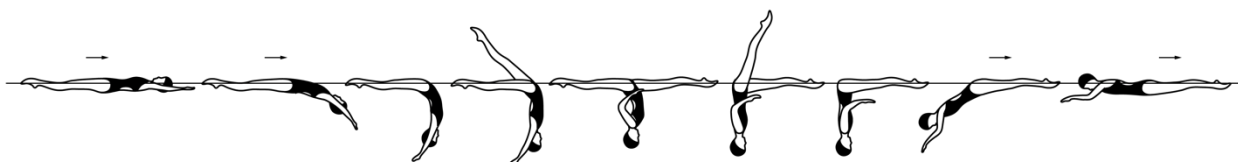


Figure – 421 WALKOVER BACK CLOSING 360°

DIFFICULTY – 2.4

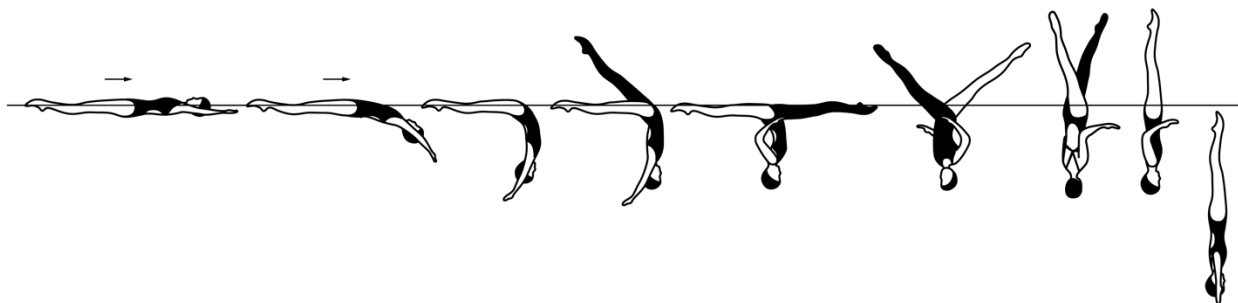


Figure – 423 ARIANA

DIFFICULTY – 2.5

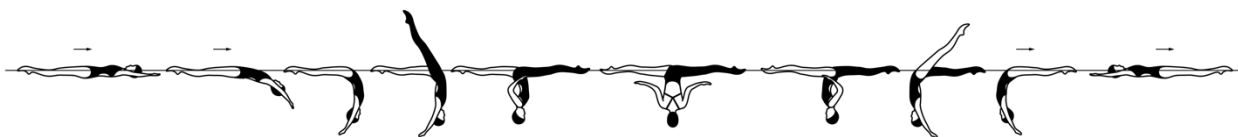


Figure – 435 NOVA

DIFFICULTY – 2.2

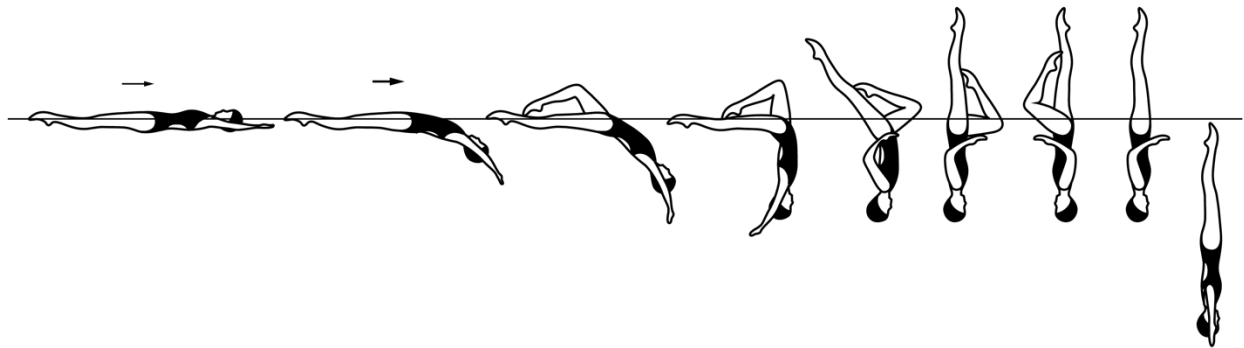


Figure – 435c NOVA TWIRL
See 112c IBIS for TWIRL

DIFFICULTY – 2.7

Figure – 435d NOVA SPINNING 180°
See 112d IBIS for SPINNING 180°

DIFFICULTY – 2.3

Figure – 435e NOVA SPINNING 360°
See 112e IBIS for SPINNING 360°

DIFFICULTY – 2.3

Figure – 435f NOVA CONTINUOUS SPIN (720°)
See 112f IBIS for CONTINUOUS SPIN (720°)

DIFFICULTY – 2.6

Figure – 435g NOVA TWIST SPIN
See 112g IBIS for TWIST SPIN

DIFFICULTY – 2.8

Figure – 436 CYCLONE

DIFFICULTY – 2.4

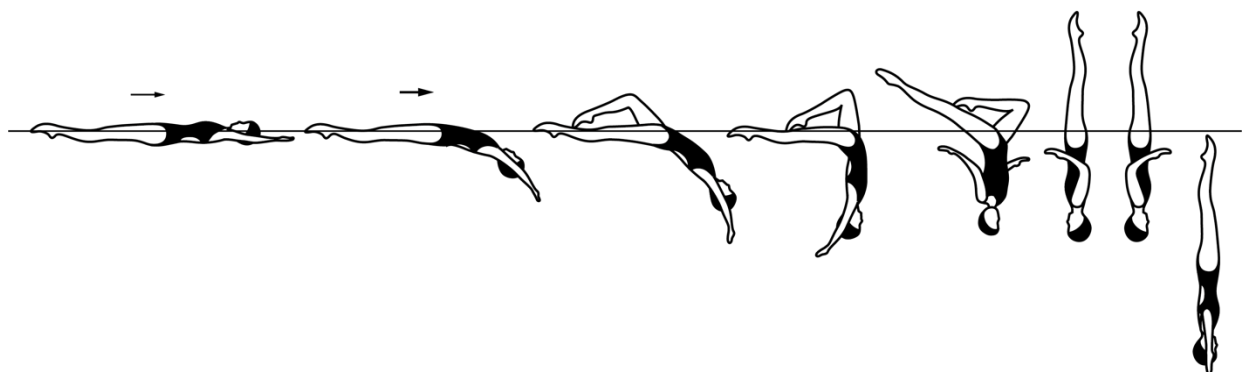


Figure – 436c CYCLONE TWIRL
See 112c IBIS for TWIRL

DIFFICULTY – 2.8

Figure – 436d CYCLONE SPINNING 180°
See 112d IBIS for SPINNING 180°

DIFFICULTY – 2.4

Figure – 436e CYCLONE SPINNING 360°
See 112e IBIS for SPINNING 360°

DIFFICULTY – 2.4

Figure – 436f CYCLONE CONTINUOUS SPIN (720°)
See 112f IBIS for CONTINUOUS SPIN (720°)

DIFFICULTY – 2.7

Figure – 437 CYCLONE OPEN 180°

DIFFICULTY – 2.6

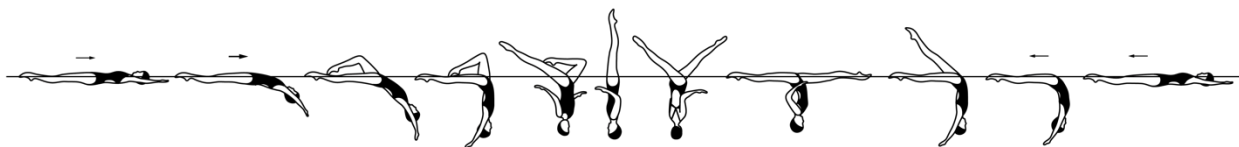


Figure – 438 OCEANEA

DIFFICULTY – 2.2

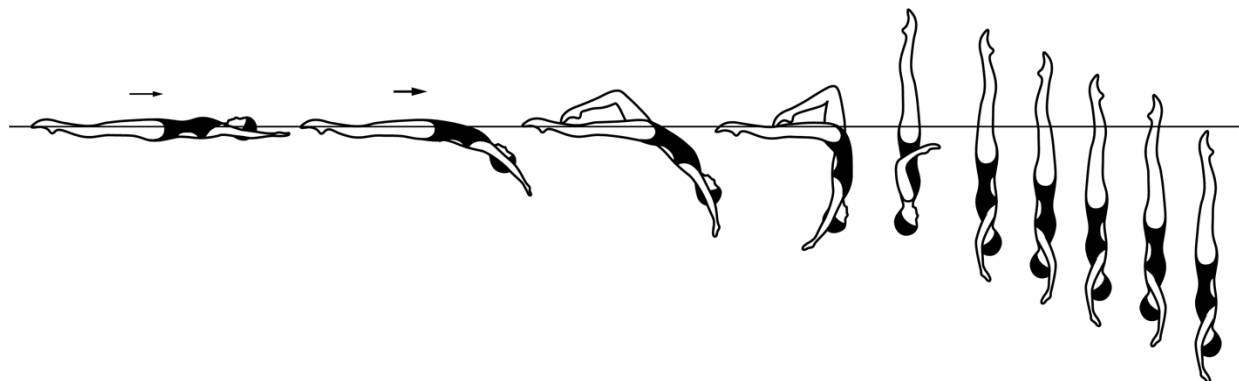


Figure – 439 OCEANITA

DIFFICULTY – 1.8

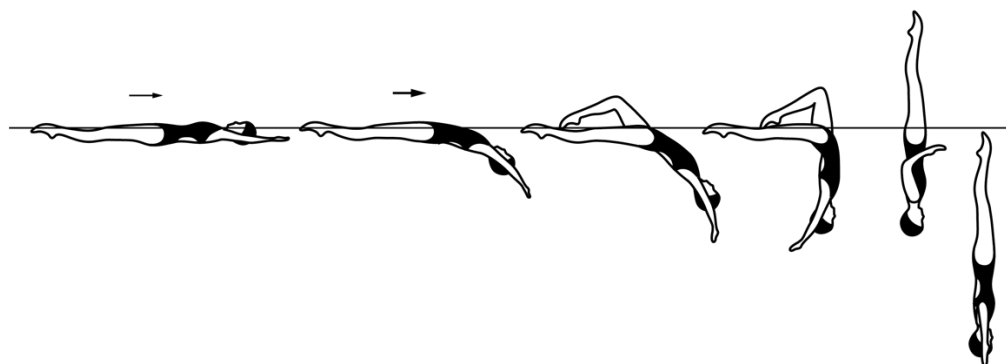


Figure – 440 IPANEMA

DIFFICULTY – 3.0

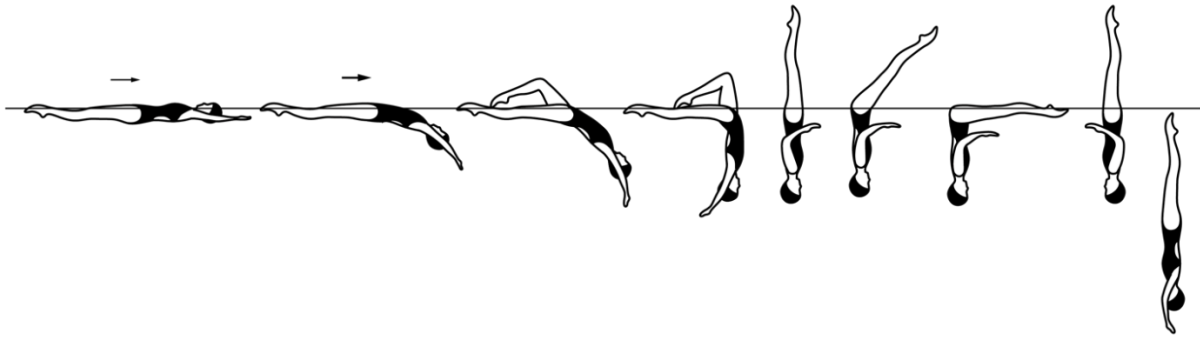


Figure – 440d IPANEMA SPINNING 180°

DIFFICULTY – 3.1

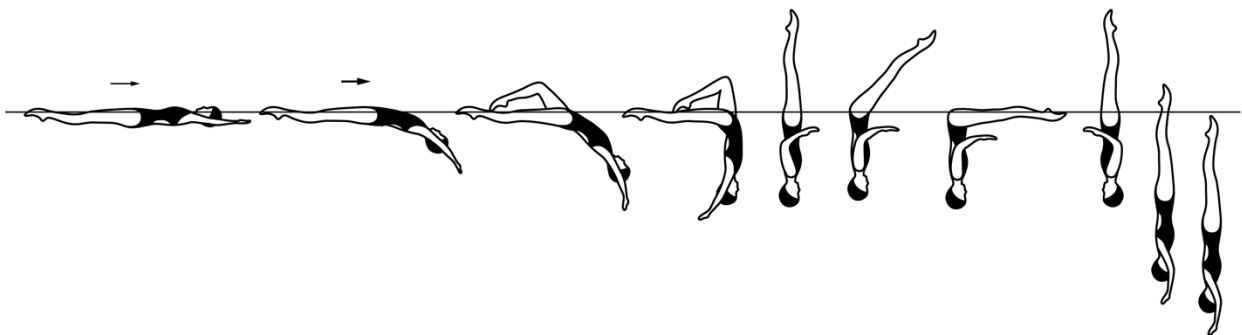


Figure – 441 SATURN

DIFFICULTY – 2.5

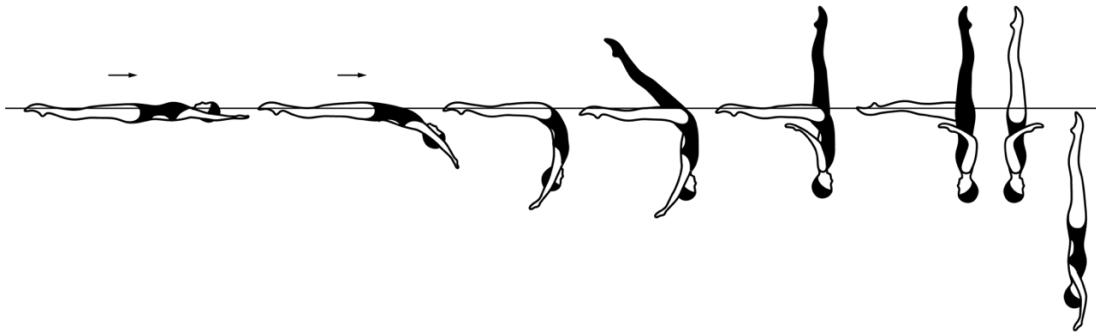
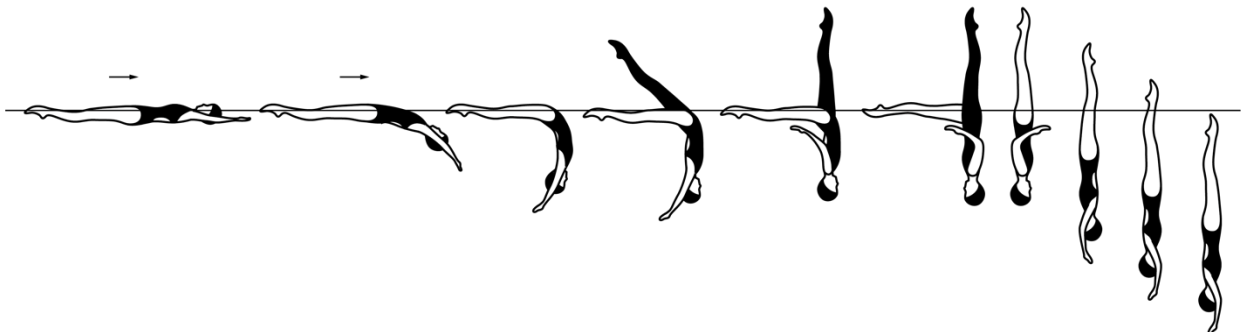


Figure – 441e SATURN SPINNING 360°

DIFFICULTY – 2.6





WORLD
AQUATICS